

**HORSE DENTAL
EQUIPMENT**

Pegasos Edition

2022-2023 CATALOGUE

Dedicated to Advanced
Equine Dentistry



For veterinary use only



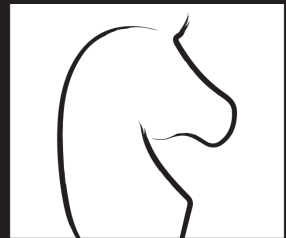

**HORSE DENTAL
EQUIPMENT**

GENERAL EQUIPMENT

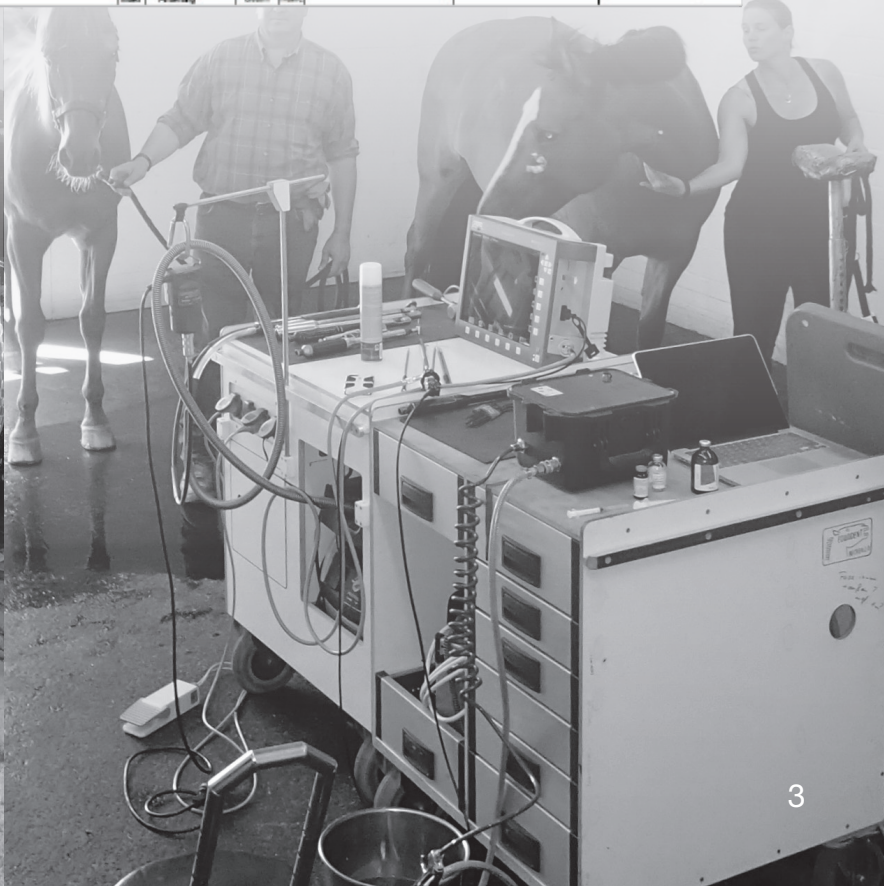
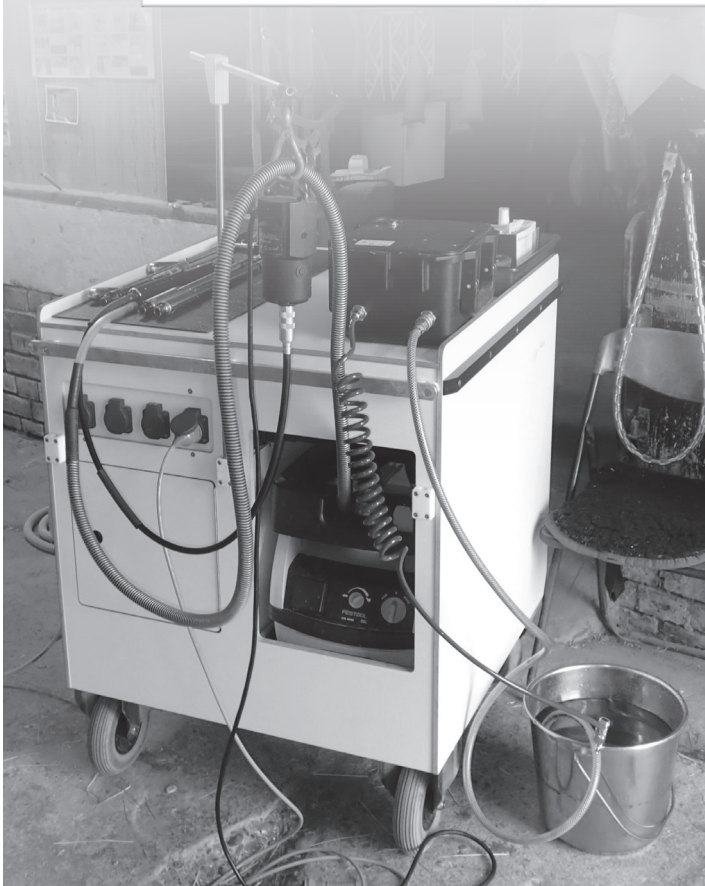
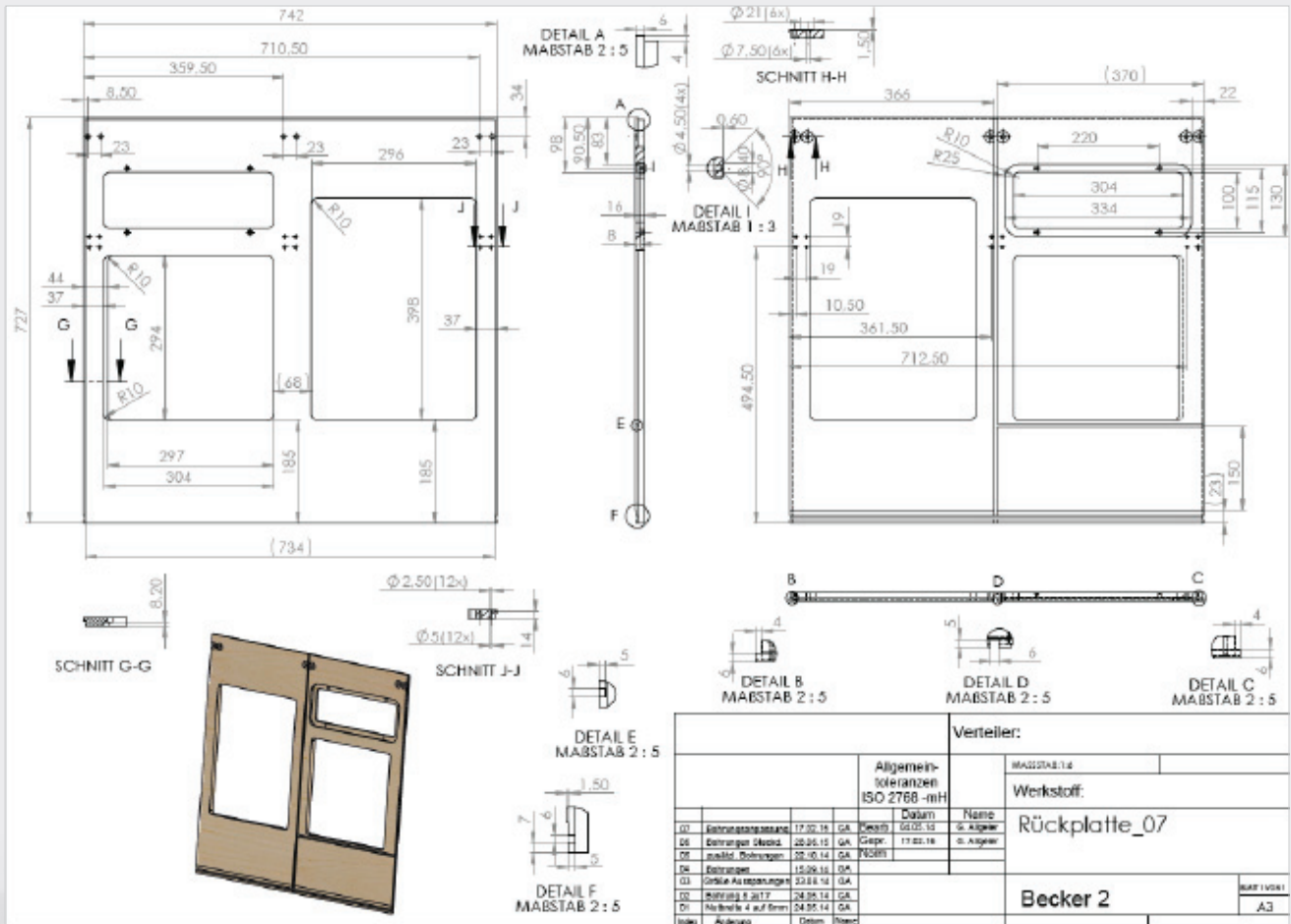

EQUODENT – DENTAL TROLLEY

Our treatment trolley was developed to place the expanding equipment for routine equine dentistry in a safe and tidy way. It creates a workplace which is easy and fast to set up, take down and accommodate in the practice car. Its versatile cube shape and mixture of

aluminum drawers) make the trolley light and robust at the same time. Its surfaces are durable and easy to clean. It fits through every door with standard widths. It is easy to manage and fits into most compact vans.



EQUODENT DENTAL BURR MODEL PETER FAHRENKRUG WITH WATERCOOLING FOR PONIES

Specially designed for ponies, thanks to its reduced size, this bullet nose head dental burr is extremely useful to perform dental treatments in narrow heads and especially in the back of the mouth.



EQUODENT DENTAL BURR WITH WATERCOOLING

This burr with IC 300-Nakanishi head was developed for the following applications:

- diastema work
- cheek tooth segmentation
- tooth crown remodeling to improve the grip of the extraction forceps
- pre-drilling during Minimally Invasive Transbuccal Extraction

The shaft bearing is greased which makes it "water-proof" and running quiet, without vibrations.

It has an external water supply enabling watercooling during drilling. This is necessary because the temperatures of the burrs (diamond or tungsten burr) can become high and can damage the tooth.



The Equodent is delivered with 2 diamond burrs, a grease tube and dismantling tools (special key and multifunctional spindle handle).



OPTIONS

- Two different heads are available with 90° or 50° angle.



The handpiece comes with the 10 mm water clip.

- 20 mm water clip is developed for the 51 mm and 64 mm Carbide Burrs
- 35 mm water clip is developed for the 64 mm and 77 mm Carbide Burrs



The handpiece comes with 2 water clips.

- 15 mm water clip
- 35 mm water clip



CARBIDE BURRS



The diamond coated diastema burr with a diameter of 3,175 mm / 0.12 inches was developed for diastema work. It fits IC-300 Nakanishi head.



For segmentation we offer carbide burrs in 4 different lengths.

For a clear storage, one can use our autoclavable storage block.

Art.-No. #	Description
PEGA_313000	Treatment Trolley
PEGA_211122	Equodent Dental Burr Model Peter Fahrenkrug for ponies - Watercooling, HDE connection
PEGA_221001	Equodent Angled Handpiece Model Michael Nowak with 90° head - Watercooling, key drive
PEGA_221002	Equodent Angled Handpiece Model Michael Nowak with 90° head - Watercooling, HDE connection
PEGA_221002_V2	Equodent Angled Handpiece Model Michael Nowak with 45° head - Watercooling, HDE connection
PEGA_WB	Waterbottle and connection
PEGA_220010	Diamond coated burr Bit (3,175 mm / 38 mm)
PEGA_220020	Carbide burr (3,175 mm / 38 mm)
PEGA_220021	Carbide burr (3,175 mm / 51 mm)
PEGA_220022	Carbide burr (3,175 mm / 64 mm)
PEGA_220023	Carbide burr (3,175 mm / 77 mm)
PEGA_220000	Storage block for burr bits (3,175 mm), autoclavable (metal, black)
PEGA_FP_FP20	Equodent foot pedal for engine N1









SECTIONING SET

This is a co-branded HDE & Pegasos package to offer the best sectioning set available on the market.

It contains a Pegasos Equodent with its 4 tungsten burrs and 2 diamond burrs. To complete your ideal set you can choose between HDE N1 and Evolution motors

with their associated drive shaft, foot pedal and instrument case.

The sectioning set is compatible with the Equus jet range rinsing systems now available with new luer lock wands (see page 10).

	SECTIONING SET N1	SECTIONING SET EVOLUTION
Equodent with 4 tungsten and 2 diamond burrs		
Motor	 <p>N1 motor + 5.5 L water tank + supply line</p>	 <p>DC Evolution motor with integrated Watercooling</p>
Drive shaft (minimum 1.20 m)	 <p>Drive shaft for N1 motor</p>	 <p>Drive shaft for Evolution motor</p>
Foot pedal control		
Instrument case		

DENTAL PROBES SHARP



The Sharp dental probes were developed for exploring teeth and cleaning interdental spaces.

It is available in 3 versions:

-Strong (18,5 mm / 0.73 inches)

-Fine (15 mm / 0.59 inches).

-Long (30 mm / 1.18 inches)

DENTAL PROBES BLUNT



The blunt probes are designed for exploring fistula canals and measuring the depth of gingival pockets and infundibular caries. 2 models are available in different lengths : 25 mm / 0.98 inches or 35 mm / 1.38 inches.

DENTAL X-RAY BLOCK



This block is a simple tool to open the mouth in 3 different angles for mouth radiographs. It is well tolerated in slightly sedated horses.

X RAY PLATES



A revolutionary set of interchangeable bite plates for your equine dental exam. Comes with an easy integrated 'slide & lock' system and therefore, no setup tools required.

Are made for taking intraoral X-ray radiograph exams of the incisors with no hindrance of material or anything else. Durable radiolucent material has been tested according to the official DAkkS-DKD-R 3-3 regulation and can withstand 5,13 KN / 513 Kg pressure. Entirely universal to fit all speculi available in the market.

X RAY PLATES JULIUSTER



Equine jaw-off-setting device for oral exams. Designed, tested and approved in collaboration with the European Equine Dental Consultancy (EEDC). Easy-to-use device to offset the lower jaw to the left or right for open-mouth views with offset-technique.

Great to investigate cheek teeth roots and occlusion surface .

Dorso-ventral views can be made with 5 cm offset to the left and right.

Art.-No. #	Description
PEGA_311001	Dental Probe Sharp strong (18,5 mm)
PEGA_311003	Dental Probe Sharp short fine (15 mm)
PEGA_311006	Dental Probe Blunt short (25 mm)
PEGA_311007	Dental Probe Blunt long (35 mm)
PEGA_311008	X Ray Block
PEGA_PLAXR	X Ray Plates
PEGA_PLAJU	X Ray Plates Juliuster

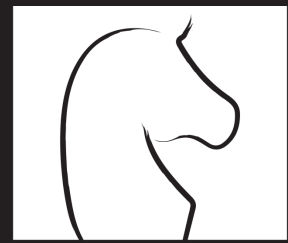

HORSE DENTAL
EQUIPMENT

EQUUS JET RANGE



EQUUS JET RANGE

Multi-purpose rinsing devices

The Equus Jet range has been developed as an autonomous, robust, compact cleaning and cooling system with the mobile equine dentistry practitioners and clinics in mind.

It is ideal for cleaning the mouth before and after dental work, diastema, rinsing after tooth extraction, sinus flushing or cooling when working with handpieces.

EQUUS JET ECO

Product features:

- High pressure (up to 10 bars)
- Flow regulated via the wands
- Lead battery (up to a week autonomy)
- Fast connecting and disconnecting tubes and wands
- Double filter system (external and internal)



The Equus Jet Eco includes the following accessories:

- One flushing wand
- One diastema wand
- An input polyurethane tube with a strainer and filter
- An output spiral polyurethane tube with fast connector on one side and fast connector with valve on the other, allowing to change the wands without shutting off the pump to save time
- A special lead battery charger

Art.-No. #	Description
PEGA_EJ-EJE02	Equus Jet Eco
PEGA_EJ-CBEP01	Equus Jet Eco charger
PEGA_EJ-LDEJ1	Diastema handpiece
PEGA_EJ-LDEJ2	Rinsing handpiece

EQUUS JET

Product features:

- High pressure (up to 10 bars)
- 5 set levels of pressure regulated via the white control panel on top
- Lithium ion battery (up to 3 weeks autonomy)
- Possibility to use a wired pedal to gradually regulate flow and pressure
- Fast connecting and disconnecting tubes and wands
- Double filter system (external and internal)



The Equus Jet includes the following accessories:

- One flushing wand
- One diastema wand
- An input polyurethane tube with strainer and filter
- An output spiral polyurethane tube with fast connector on one side and fast connector with valve on the other, allowing to change the wands without shutting off the pump to save time
- A special lithium ion battery charger

Art.-No. #	Description
PEGA_EJH-EJ11	Equus Jet
PEGA_EJ-EJ04	Equus Jet - Option Pegasos Trolley option
PEGA_EJ-CBLI14	Equus Jet charger
PEGA_EJ-LDEJ1	Diastema handpiece
PEGA_EJ-LDEJ2	Rinsing handpiece
PEGA_EJH-PDC02	Equus Jet Foot Pedal
PEGA_EJH-KLS02	Equus Jet Sinus Kit

EQUUS JET CONNECT

Product features:

- High pressure (up to 10 bars)
- Control screen with general settings and display : pressure, temperature, battery level, pumps, pedal, pairing
- Bluetooth and Android application
- Lithium ion battery (up to 3 weeks autonomy)
- Possibility to use a wired pedal to gradually regulate flow and pressure
- Fast connecting and disconnecting tubes and wands
- Double filter system (external and internal)



The Equus Jet Connect the following accessories:

- One flushing wand
- One diastema wand
- An input polyurethane tube with a strainer and filter
- An output spiral polyurethane tube with fast connector on one side and fast connector with valve on the other, allowing to change the wands without shutting off the pump to save time
- An outlet tube with fast connector on the pump side for the cooling pump
- An tube with luer connector for the peristaltic pump
- A special lithium ion battery charger

Art.-No. #	Description
PEGA_EJ-EJV21-2	Equus Jet Connect with 2 pumps (high pressure rinsing and low pressure watercooling)
PEGA_EJ-CBLI14	Equus Jet charger
PEGA_EJ50630	Peristaltic pump
PEGA_EJH-PDC02	Equus Jet Foot Pedal
PEGA_EL-PC01	Wireless Pedal
PEGA_EJH-KLS02	Equus Jet Sinus Kit
PEGA_EJ-LDLL90	Diastema luer lock wand for Equus Jet
PEGA_EJ-AIDG18	Luer lock Needles Box of 10 needles in several lengths and diameters
PEGA_EJ-EDB02	Dimmer Box Connect

EQUUS JET RANGE

Comparative table

	EQUUS JET ECO	EQUUS JET	EQUUS JET CONNECT
Battery type	Lead	Lithium ion	Lithium ion
Battery autonomy**	Up to a week**	Up to 3 weeks**	Up to 3 weeks**
Pressure level	Up to 10 bars	Up to 10 bars	Up to 10 bars
Number of pressure levels	1	5	6
Control panel with pressure regulation		✓	✓
Fast connecting and disconnecting tubes and wands	✓	✓	✓
Double filter system (external and internal)	✓	✓	✓
High pressure pump	✓	✓	✓
Cooling pump			✓
Peristaltic pump			✓ *
Pegasos trolley option		✓ *	✓ *
Control screen with general settings and display : pressure, temperature, battery level, pumps, pedal, pairing			✓
Bluetooth and Android application			✓
Wired foot pedal control		✓ *	
Wireless foot pedal control			
Kit sinus		✓ *	✓ *
			

* Optional. **Average autonomy.

EQUUS JET RANGE ACCESSORIES

EQUUS JET ECO CHARGER

Different sockets available:
French, Swiss, UK, USA



EQUUS JET AND EQUUS JET CONNECT CHARGER

Different sockets available:
French, Swiss, UK, USA



WIRED FOOT PEDAL

The wired foot pedal allows you to control the pressure of the Equus Jet directly with your foot.

You keep freedom of movement as well as the availability of your hands while keeping the pressure setting.

This pedal is used with Equus Jet.



WIRELESS FOOT PEDAL CONNECT

This Bluetooth wireless Foot Pedal Connect, allows you to control:

- the speed of the Equus Jet Connect
- the Equus Jet Connect pump
- the Dimmer Box Connect
- the options such as the reversal the motor rotation direction, the start or stop of the water pump running with the motor.



PEGASOS TROLLEY OPTION

Thanks to this system you can fix your Equus Jet on your Pegasus trolley.



RINSING WAND

Rinse the horse's mouth in one single gesture, with upper and lower opening. High flow with slight pressure to remove food debris before and after equine dental treatment. Its length allows you to easily access the back of the mouth without hurting the horse.



DIASTEMA WAND

Diastema wand with a 90° angle to clean interdental spaces, diastemas and cavities after extraction, wounds. Its length allows you to easily access the back of the mouth without hurting the horse.



DIASTEMA LUER LOCK WAND

This new diastema lance allows you to use needles of different lengths as well as to tilt them in the desired area.



LUER LOCK NEEDLES

Box of 10 straight stainless needles for Equus Jet luer lock wand in several lengths and diameters.



SINUS KIT

This kit allows you to clean the horse's sinuses with the Equus Jet. It's recommended to use the pedal to vary the pressure flow.



PERISTALTIC PUMP



DIMMER BOX CONNECT

Equus Dimmer Box Connect, connected management box for the use of a wireless foot pedal and to control the Storz endoscope.



INSTRUMENTS FOR DENTAL EXTRACTIONS

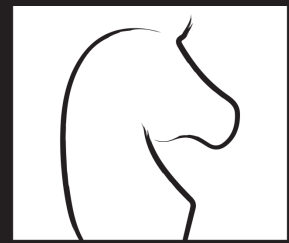

HORSE DENTAL
EQUIPMENT

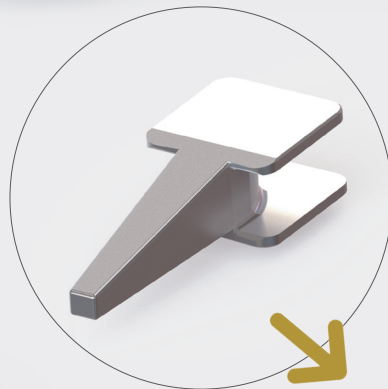
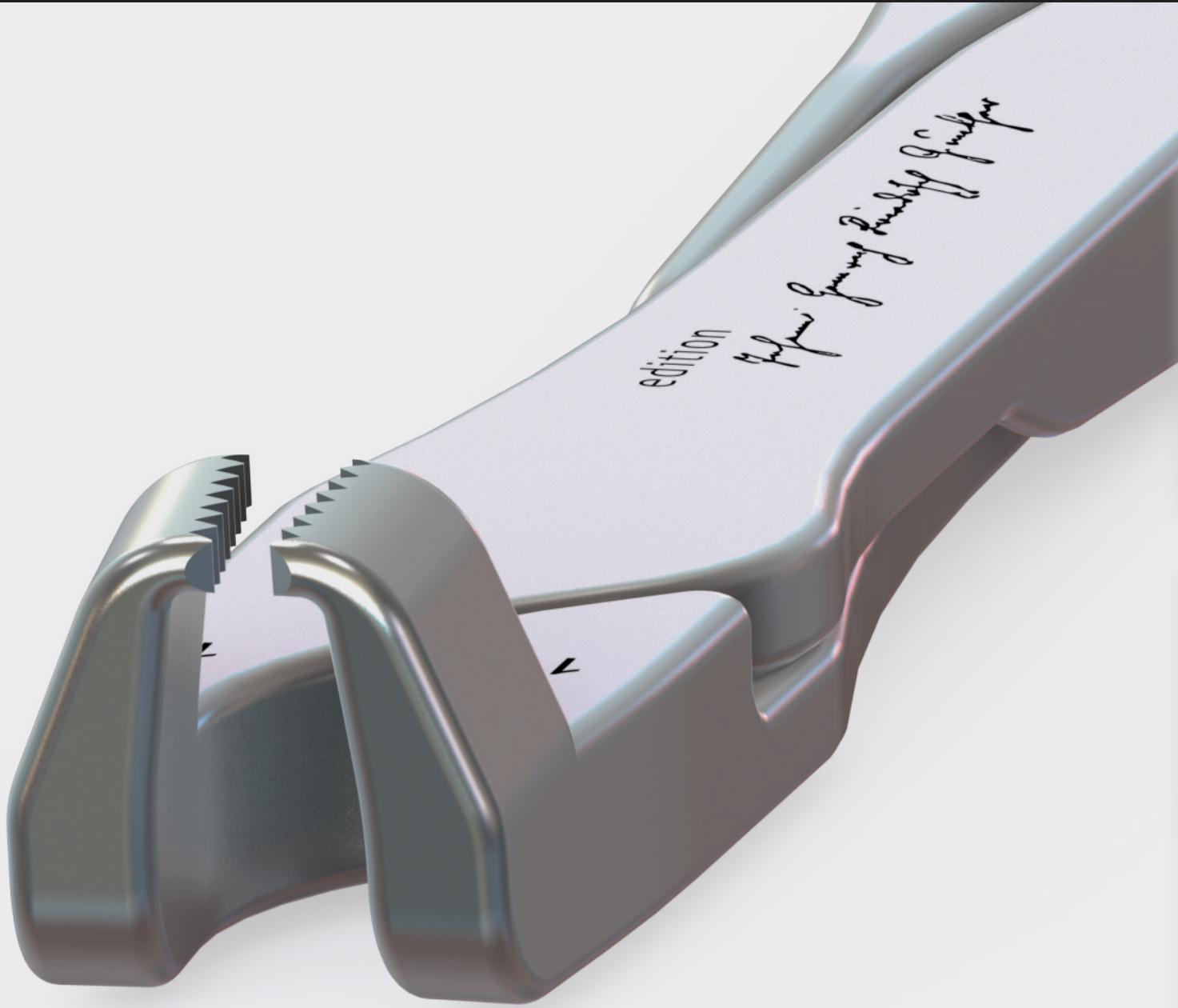

THE EXTRACTION SYSTEM FROM PEGASOS4D MODEL: HAUPTNER

Edition: Johann Heinrich Friedrich Günther



Comments on Model and Edition

Model Hauptner: The development and construction of these instruments was supported by the company Hauptner. Hauptner has more than 150 years experience on making instruments and produced in the past some of the best forceps available at that time.

Edition: Johann Heinrich Friedrich Günther

Who was J. H. Friedrich Günther and what influence did he have to the method of oral extraction of teeth?

He was born in 1794 in Germany. He got educated in Jena, Berlin and Hanover. After he had finished "Royal Equine Vetschool" Hanover in 1818 he started to work as a veterinary surgeon. Only one year later he was called by the school to become a teacher. Apart from his work at the vetschool he ran a private clinic where he taught the older students the practical part. Additionally he was an inspector at the Marstall and gave lessons at the military academy. Since 1840 he did research as well.

In 1847 he became the director of the Hanovarian vetschool. He strongly increased the level of education of veterinary surgeons during that time.

Alongside teaching he did a tremendous high quality work concerning the development and construction of surgical instruments. Furthermore, he gathered a comprehensive collection of diseased teeth. He is, indeed, considered as a founder of the equine dental surgery. Together with his son he wrote a booklet about horses' teeth which was published in 1859, one year after he had died.

Even 50 years after his death his extraction forceps were widely used and highly valued. He was doing oral extraction of equine teeth at a high level. Unfortunately this knowledge got lost over the following century. His early work is only little known and it is a mission to make it accessible again to veterinarians. His early literature of 1859 is highly recommended because it is still up to date in many respects. In order to support the rediscovery of his work we named this forceps and spreader line after him: Edition "Günther".

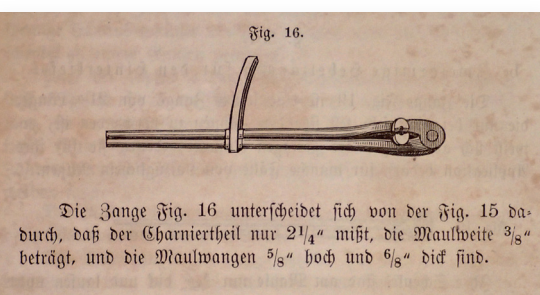
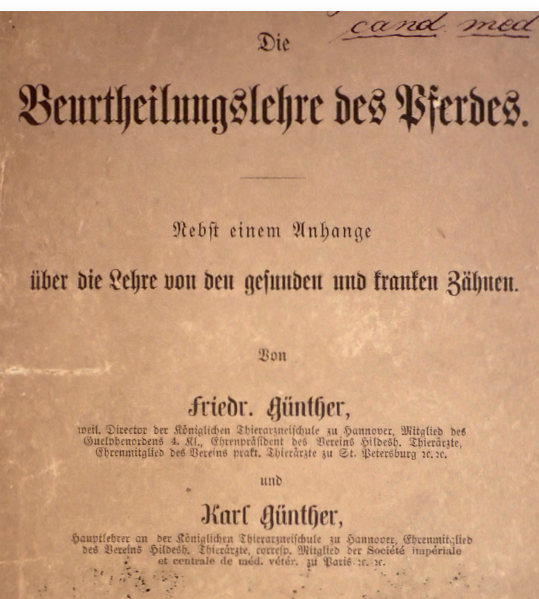

The Spreader and Forceps System was developed to improve oral extraction techniques in equine dentistry.

Great efforts have been invested to design the instruments as ergonomic and efficient as possible. The different sizes of spreader blades enable a standardized stepwise working process. Thereby, the duration and success rate of the extractions are influenced very positively.

The extreme precision of the joint creates the possibility to disassemble and reassemble the single halves of the instruments. It enables a variety of combinations that has not been available yet, like the combination of spreader and forceps within one instrument. It is most helpful in cases of slab fractures and very tight interdental spaces especially in the lower jaw. It also enables a thorough cleaning of all parts.



Manufacturing

- Instruments are made of heat-treated surgical stainless steel.
- The body is milled out of one piece on a 5-axis-CNC-milling centre.
- The spreader inserts are laser-welded and labeling is done with a laser marking system.
- The construction was tested with FEM-analysis and does still have, at a 80 kg handle pressure, a safety factor of 3.
- Made in Germany*.
- 5-year warranty.

General notes on maintenance

The possibility to disassemble the instruments enables easy and thorough cleaning. This should be done after each use. From time to time the fulcrum pin should be treated with surgical instrument silicone spray.

All instruments are fully autoclavable and chemically disinfectable.

MOLAR SPREADERS

Molar spreaders are used to loosen the periodontal ligament and hence the tooth, through applying it to the interdental space.

There are three different spreader sizes. They allow a standardized stepwise working process. This enables a very careful and crown-saving work. It significantly improves the success rate of oral extractions.



Art.-No. #	Description
PEGA_320001	Molar Spreaders No. 1 – thickness 4 mm
PEGA_320002	Molar Spreaders No. 2 – thickness 5 mm
PEGA_320003	Molar Spreaders No. 3 – thickness 6 mm

Differences between No. 1–3

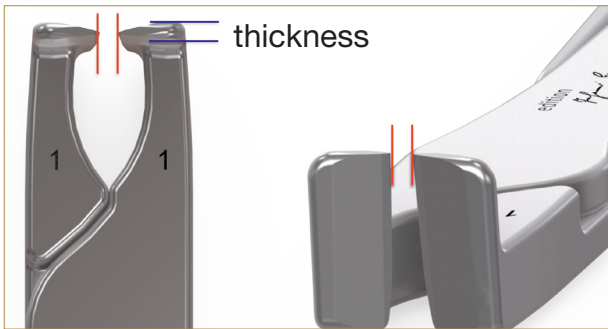

Molar Spreader No.1, the thinnest one with a 4 mm (0.16 inches) thickness (blue), does additionally have a cleft (red) between the jaws. Therefore, the handles don't need to open that far. This enables a more ergonomic first spreading step. One can apply a much more controlled force. This is especially helpful in case of fragile teeth.

The varying jaw thickness enables different spreading effects.

Spreader No. 1 – Narrow – the 4 mm (0.16 inches) thickness works much finer than No. 2 – Medium. No. 1 is mainly used as the first step spreader for the maxillary cheek teeth because they are wider than mandibular cheek teeth.

Spreader No. 2 – Medium – the 5 mm (0.19 inches) thickness works for the upper jaw as a second step and for mandibular cheek teeth as a first step.

Spreader No. 3 – Wide – the 6 mm (0.24 inches) thickness is used only partially (1/3-2/3) for the maxillary cheek teeth and up to full effect for mandibular cheek teeth.

It is recommended to use the forceps to loosen the tooth with rotational movements between the spreading steps, otherwise the risk of breaking the tooth/roots will increase.

Interchangeability

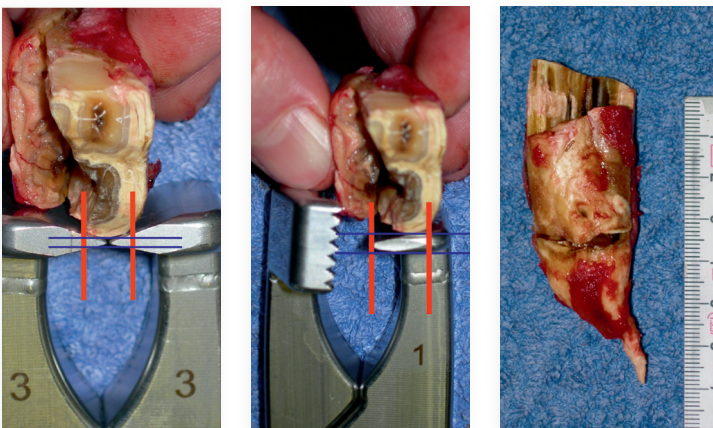

Additionally, the application of spreaders in combination with forceps is possible thanks to its interchangeability. This is especially helpful in cases where the interdental space is not wide enough to use conventional spreaders. This is the case in slab fractures and for the lower jaw.

Cavity: one has to be careful on side of the forceps part otherwise breakage of the tooth can occur.

EXTRACTION FORCEPS



Extraction forceps are used to further loosen teeth with rotational and tilting movements and finally to extract the teeth in combination with a fulcrum.

The **Extraction Forceps No. 1** is particularly helpful for mandibular cheek teeth extractions but can also be used for the upper jaw.

The **Extraction Forceps No. 2** is specifically designed for the wider maxillary cheek teeth. The Extraction Forceps can be disassembled and reassembled again in many different ways like the spreaders.

For horses with small heads we developed the **"Pony Model"**. The actual version is dedicated to **Professor Padraic Dixon** from the University of Edinburgh who, at the end of the 20th century, made great efforts to re-introduce oral extraction techniques.



REVERSE FULCRUM EXTENSION SET



REVERSE FULCRUM

Thanks to this new Reverse Fulcrum Extension there is no extra Reverse Fulcrum Forceps needed. This system works both for lower and upper cheek teeth. It is especially recommended for 06 and 07's. It can be a quite helpful approach for lower 09 and 10 as well due to the curved nature of these teeth.

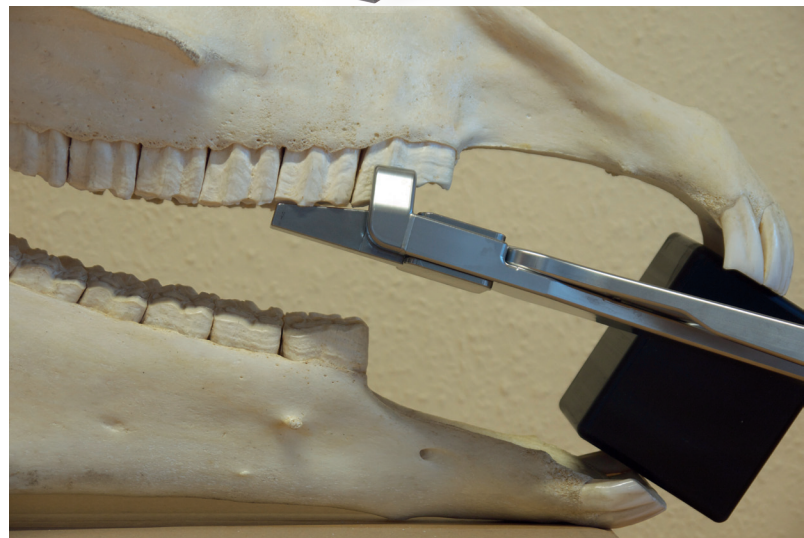
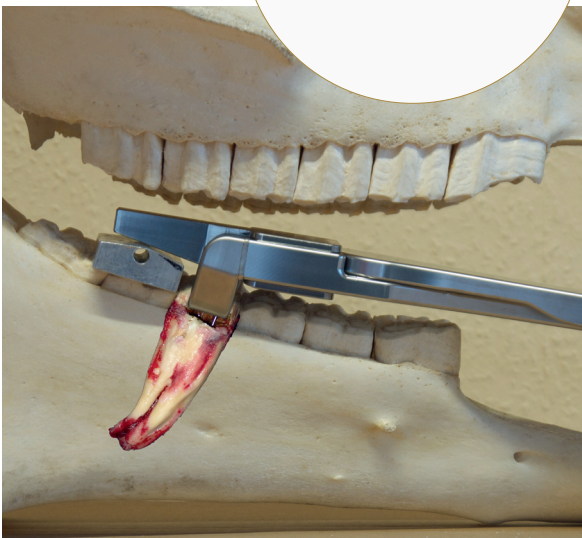
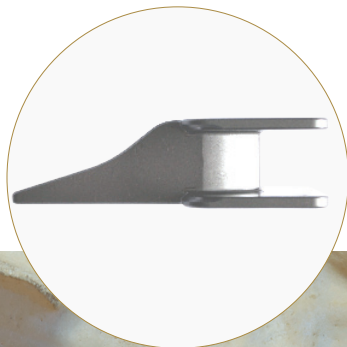

Art.-No. #	Description
PEGA_321020	Molar Forceps – Pony
PEGA_321001	Molar Forceps No. 1 – large
PEGA_321002	Molar Forceps No. 2 – large
PEGA_321010	Reverse Fulcrum Extension (fits Molar Forceps No. 1 and No. 2)

KIT FOR MINIMALLY INVASIVE TRANSBUCCAL EXTRACTION (MTE)

The MTE technique is indicated in the following cases:

- Force applicable to the crown is insufficient
- Crown is broken off or too fragile
- Malformation of the crown
- Removal of root fragments

To use the MTE Kit, it is necessary to attend a workshop where this technique is taught in-depth.

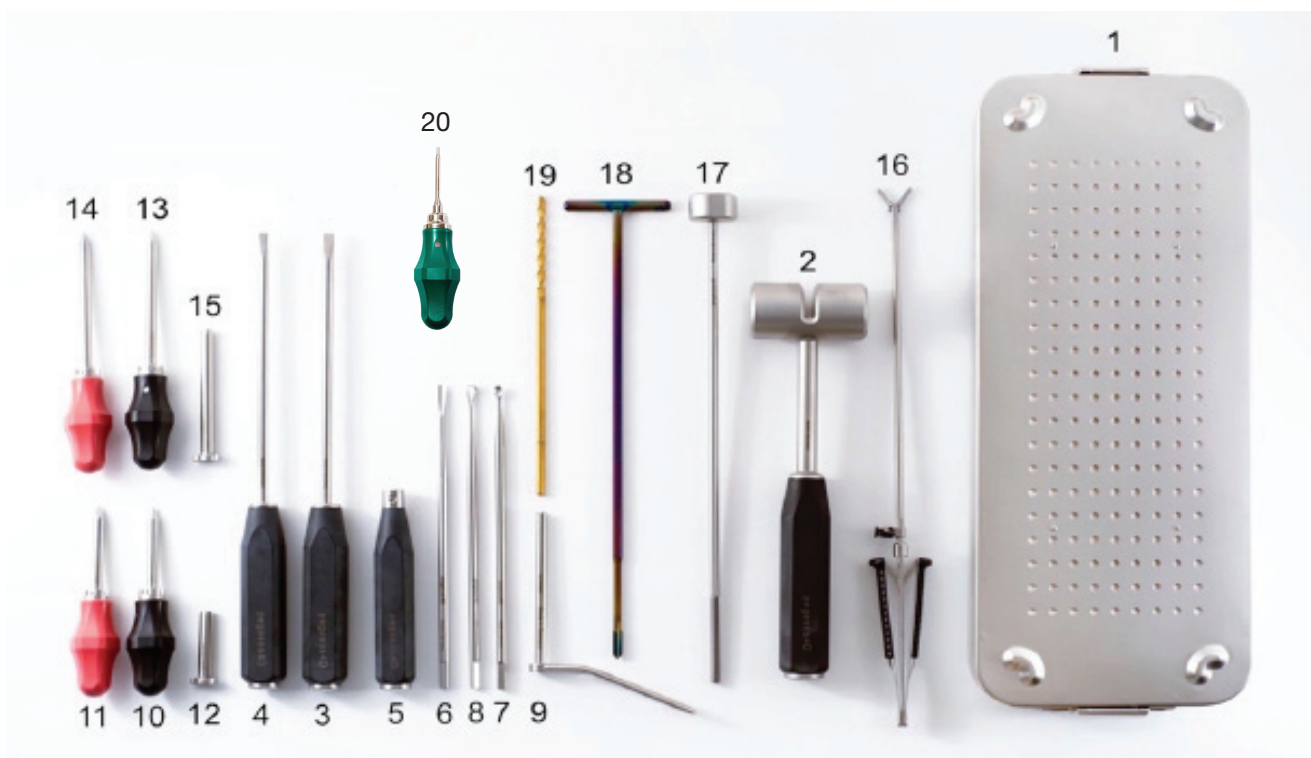

Art.-No. #	No.	Description
PEGA_322000		MTE Kit
PEGA_UM301040	14	Long sharp trocar
PEGA_UM301041	13	Long blunt trocar
PEGA_UM301015	15	Long trocar sleeve
PEGA_UM301038	11	Short sharp trocar
PEGA_UM301039	10	Short blunt trocar
PEGA_UM301014	12	Short trocar sleeve
PEGA_UM301102	4	Dental chisel - offset
PEGA_UM301100	3	Dental chisel - plain

Art.-No. #	No.	Description
PEGA_UM312001	5	Short handle
PEGA_UM312010	6	Luxator
PEGA_UM312012	8	Loop
PEGA_UM312011	7	Sharp spoon
PEGA_UM301051	9	Drilling sleeve
PEGA_UM301042	19	Drill
PEGA_UM301044	18	Threading tap
PEGA_UM301045	17	Extraction screw
PEGA_UM301090	2	Hammer
PEGA_UM301130	16	Root fragment forceps (very fragile)
PEGA_UM301140	1	Autoclavable container
PEGA_310110	20	Autoclavable Screw Driver

DENTAL PICKS

DENTAL PICK SET - BASIC

This set contains an 8° handle, a set of 5 mm / 0.19 inches luxators in different lengths and a non-autoclavable screwdriver. It can be used to loosen gingiva, to remove tooth fragments or remaining roots. The luxators have a fine and sharp tip and can be applied in any turning direction.

The short and blunt insert is intended to fix the screw during transport.



Art.-No. #	Description
PEGA_310100	Dental Pick Set - Basic T-Handle - 8°, Wide Luxator Set, 5 mm (0.19 inches), Black screwdriver (non-autoclavable)
PEGA_310101	T-Handle - 0° - without screwdriver
PEGA_310102	T-Handle - 8° - without screwdriver
PEGA_310103	T-Handle - 18° - without screwdriver
PEGA_310104	T-Handle - 30° - without screwdriver
PEGA_310000	Wide Luxator Set - 5 mm (0.19 inches), 5 different lengths
PEGA_310010	Narrow Luxator Set - 4 mm (0.16 inches), 5 different lengths
PEGA_310020	Chisel Set - 4 mm (0.16 inches), 5 different lengths
PEGA_310030	Probe Set, 5 different lengths
PEGA_310040	Sharp Spoon Set, 4 different lengths
PEGA_310106	Storage block, autoclavable (metal)
PEGA_BSD	Black Torx-Screwdriver (stainless steel, non autoclavable)

DENTAL PICK SYSTEM: 4 DIFFERENT HANDLES

Dental picks are intended for intraoral use.
There are 4 different handles, corresponding to 4 different angles:

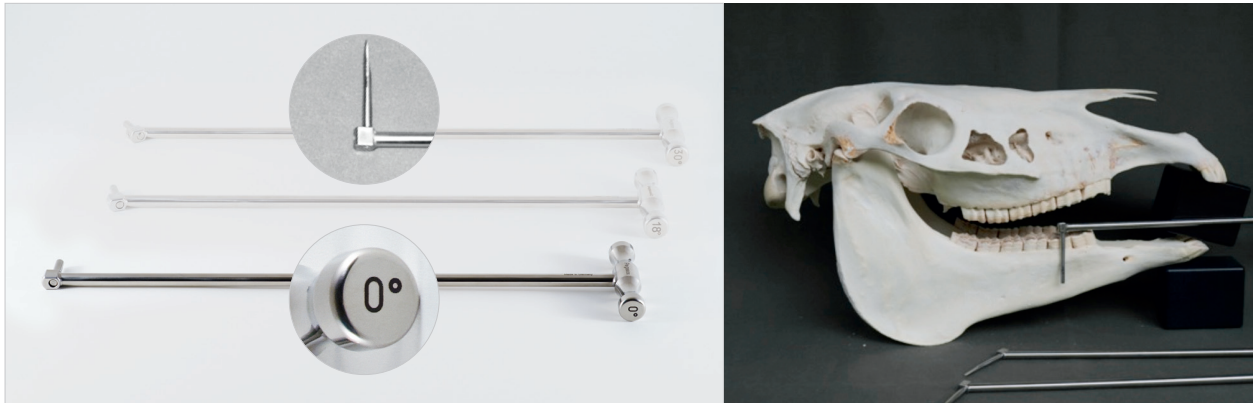

The **0°** Handle can be helpful for the mandibular jaw.



The **8°** Handle is the most often used one (up to 80% of the cases can be solved with it).
Inserts can be used in a backward direction as well (helpful for lower premolars).



The **18°** and **30°** Handles are used for the more caudal teeth.

INSERTS

Additionally, there are different types of inserts available. They can all be used with the short straight handle as well to have even more versatile applications.



Narrow Luxator Set – 4 mm / 0.16 inches (5 lengths)
The narrow luxators are used for extra small fragments.



Chisel Set (4 lengths)
The chisels are used to get into the interdental space to loosen or remove tooth fragments.



Probe Set (5 lengths)
These probes are particularly useful for exploring deep fistula canals and other dental and periodontal pockets.

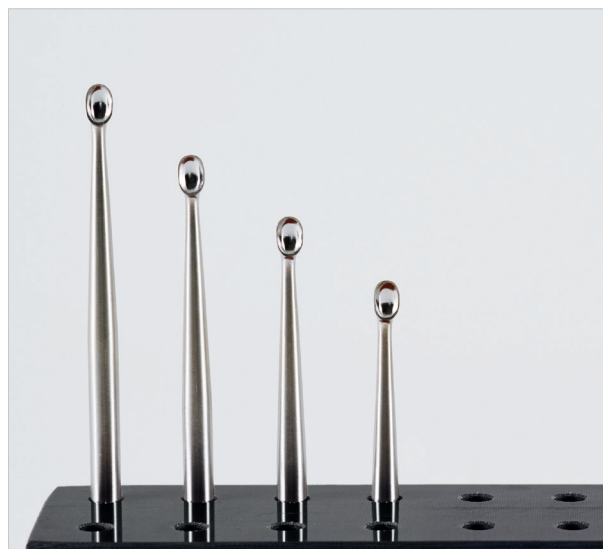

Sharp Spoon Set (4 lengths)
These curettes are useful for cleaning the tooth socket and removing deep root fragments.

SHORT HANDLE EXTRACTION KIT



This kit consisting of a short handle with different luxators is very useful for the extraction of wolf teeth, incisors, canines and deeply located root fragments.

It contains straight, concave and convex curved luxators in a 4 and 5 mm / 0.16 and 0.19 inches version.

Particularly the concave curved tips allow a very good access to the palatal side of the wolf tooth and enable a careful extraction with minimal damage.

The short handle is designed to allow the gentle usage of a hammer as well. Furthermore, this short handle can be combined with all different inserts from the Dental Pick System.

Shapes

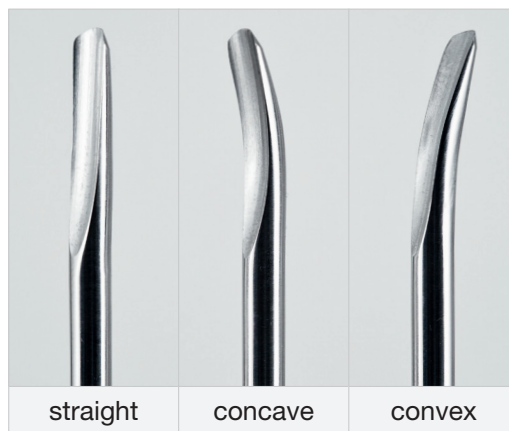

Widths

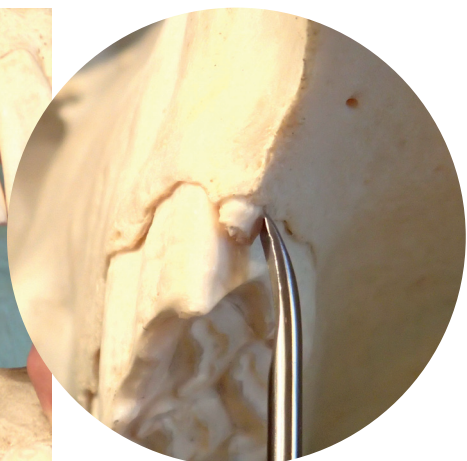
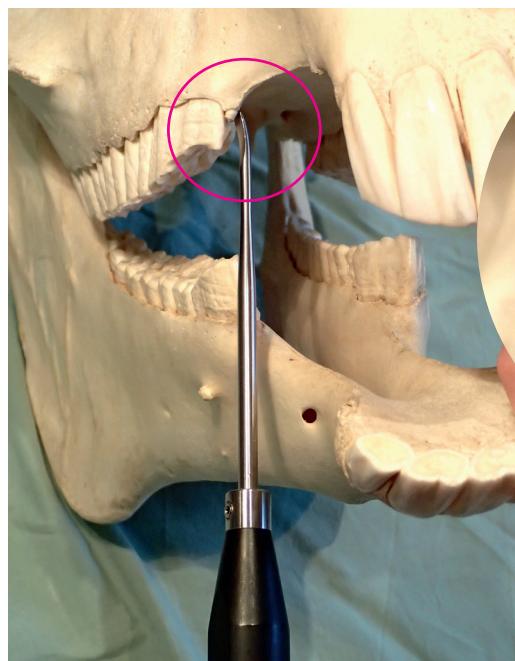
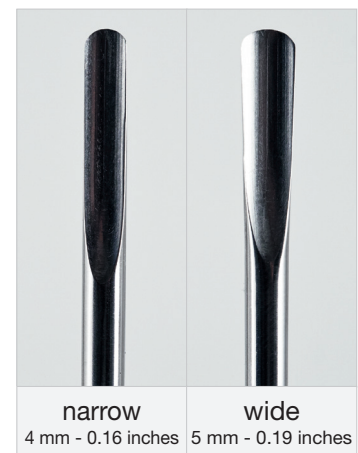

Art.-No. #	Description
PEGA_312001	Handle (short, straight)
PEGA_312004	Luxator Insert 150/4 straight
PEGA_312002	Luxator Insert 150/5 straight
PEGA_312005	Luxator Insert 150/4 concave
PEGA_312003	Luxator Insert 150/5 concave
PEGA_312006	Luxator Insert 150/4 convex
PEGA_312007	Luxator Insert 150/5 convex
PEGA_312040	Wolf Tooth Extraction Kit with screwdriver Contains a short handle and 4 luxators (straight and concave curved inserts in 4 and 5 mm width)
PEGA_312041	Extraction Kit with short Handle and 6 Luxators with screwdriver Contains a short handle and 6 luxators (straight, concave and convex curved inserts in 4 and 5 mm width)
PEGA_RSD	Red Imbus Screwdriver (non autoclavable)

SPECIAL NOTE

Veterinary techniques develop continuously.

Therefore all comments in this catalogue can reflect only the current knowledge.

The users of our instruments are asked to update their knowledge accordingly. Please contact us in case of any queries.



HEADQUARTERS

Horse Dental Equipment
Châteaubourg (35)
FRANCE

Tel: +33 (0)2 99 00 71 29

www.horse-dental-equipment.com

HDE AMERICAS

HDE North America LLC
New York, NY
USA

Cell: +1 (970) 442-3601

www.horse-dental-equipment.us