



MAI ANIMAL HEALTH

Treating Animals. Differently.™



Product Catalog
8th Edition

MAI ANIMAL HEALTH GLOBAL LOCATIONS

MAI Animal Health - UNITED STATES

605 Pro-Ject Drive
Elmwood, WI 54740
1.800.447.0687
sales@maianimalhealth.com

MAI Animal Health - EUROPE

4 Merlin Way
Bowerhill Industrial Estate
Melksham, Wiltshire SN12 6TJ
+44 (0) 1225 791 184
sales.uk@maianimalhealth.com

MAI Animal Health - AUSTRALIA

5-7 Burrundulla Road
P.O. Box 1147
Mudgee NSW 2850
+61 (0) 2 6372 6622
sales.au@maianimalhealth.com

MAI Animal Health - NEW ZEALAND

3A Marken Place
Glenfield, Auckland 0627
+64 (0) 9 444 2115
sales.nz@maianimalhealth.com

WELCOME

Welcome to the eighth edition of the annual MAI Animal Health Product Catalog!

We have continued, just as in previous years, to develop new methods to communicate and provide information to clients. Our multiple divisions continue to develop innovative products for clinic and patient applications. We strive to create new products to address the issues clients are facing on their farms and in their practices today.

Please browse our catalog, as well as the online resources on our brand new website. We provide information in multiple formats for utilizing our products for effective clinical applications.

Wishing everyone good health and continued success!

Best wishes,

Mark L. Anderson, D.V.M.

See our other Mini-Catalogs for even more detailed product information:

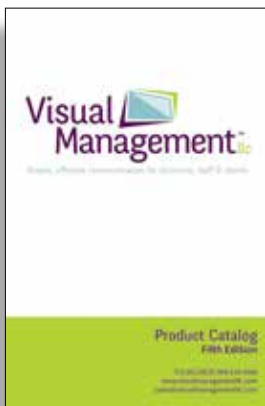

Visual Management - 5th Edition



**Universal Surgical Instruments -
2023 Edition**



Equine Dental Instruments - 5th Edition

Products are available through your preferred distributor or dealer.

BRANDS & MANUFACTURERS



Genesis Industries, Inc. offers a wide variety of plastic containers and accessories designed to meet customer packaging and product delivery needs. Syringes, Serum Bottles, Cylinders, Boston Rounds and a range of Back Pack containers are manufactured in a variety of sizes using FDA compliant plastic resins and colorants to provide the highest quality container possible. The experienced Research & Development team at Genesis Industries offers innovative design, prototyping and development services for any packaging requirements of a pharmaceutical, biologic or vaccine manufacturer.



Genesis Instruments is a manufacturer of quality instruments, delivery systems and specialty products serving the animal health industry. We manufacture unique delivery systems for injectable, topical and oral animal health products. Our delivery systems are recognized for accurate and consistent delivery, as well as ergonomic design.



Inovadent™ is a manufacturer of a variety of equipment for small animal dentistry. Products include handpieces, KLAW™ Tips, comprehensive dental carts and wall mount systems. Inovadent™ provides durable products to meet the demands for convenience, quality and value.



The McCulloch Medical™ Constant Delivery™ Aspirator / Resuscitator and One Puff™ are simple to use, handheld instruments to clear respiratory passages and pump air into a struggling newborn animal's lungs. McCulloch Medical™ also offers specialty masks and adapters for aerosol drug delivery and anesthesia, as well as Anesthesia Chambers and the Wild Child™ feline management system.



MDS-Vet™ is dedicated to providing customers with unique and affordable optical, video and fiber-optic equipment for the animal health industry. Offering endoscopy services allows clinics to increase revenue while providing a specialty service for clients.



MAI™ is a custom manufacturer of unique products serving the animal health industry, including a full range of supplies for use with Artificial Insemination, Embryo Transfer and In Vitro Fertilization techniques, as well as a range of flexible tubing and vinyl products used for oral feeding and intravenous fluid therapy. Specialty products are designed for use by veterinarians and producers working with a variety of species including companion and food producing animals.



ESTROTECT™ is a proven brand identifying standing heat in dairy and beef cattle for more than 20 years. The effective and inexpensive scratch-off system has proven to be reliable whether used in artificial insemination, natural breeding or synchronized breeding. The newly introduced ESTROTECT™ Breeding Indicator with Breeding Bullseye™ technology provides enhanced value for reliable breeding time.



Veterinary Dental Products, LLC specializes in manufacturing quality dental products specifically for use in equine dentistry. Veterinary Dental Products is committed to addressing the needs of equine dental practitioners through the development of new, innovative products and by improving our current product offering.

CREATIVE PET PRODUCTS™

Creative Pet Products™ pioneered first aid kits and related accessories for companion animal brands including Bow Ow™ for dogs, Me Ow™ for cats, Sporting Dog™ for hunting / athletic dogs, as well as Horse Aid™ for competition and endurance equine. The emphasis of all first aid kits includes stabilizing an injured patient prior to transporting to a veterinary clinic or hospital. An additional focus relates to service dogs including military, police, border patrol and other areas of intense training and risk.



Jerry's Equine Dental Tools offers unique and innovative products for equine dental care. Numerous variations of power-driven equine dental systems provide users a wide selection of durable and dependable instruments. In addition, Jerry's Equine Dental Tools provides equine support products, as well as a mobile equine clinic system.



ICPbio Reproduction™ is a global supplier of Embryo Transfer and Reproductive products including flushing and embryo handling media for equine, bovine and ovine used by veterinarians and reproductive specialists. ICPbio Reproduction™ also manufactures and distributes the Ovagen™ brand FSH for superovulation of ovine and bovine for Embryo Transfer procedures in select markets.



The Dr. Larson Company offers products designed specifically for dairy cattle applications and functions. A variety of nutritional supplement products for transition cows are available to promote and support optimal milk production. A variety of products for udder health are also a part of the Dr. Larson's™ portfolio, as well as numerous specialty products for various species.



Value Diagnostics offers a simple and precise portable test system for measuring IgG in serum, plasma and colostrum to address the needs of newborn animals. The DVM Rapid Test™ II is a cost effective, portable and highly accurate point-of-care instrument to be utilized with a variety of test kits designed for multiple species.



Visual Management LLC™ offers a variety of simple visual communication aids for clinicians, staff and clients. Clip-Its™, Write-Boards™ and Business Signs allow effective communication for the ultimate promotion of high quality patient care. Visual Management also provides marketing material for promotional needs.



Har-Vet™ is an industry leader in equine veterinary products. Har-Vet™ offers a wide variety of products designed specifically for equine reproduction and other specialty needs.



The Edge Equine™ is an Australian-based manufacturer of equine dental equipment. The Edge Equine's major focus relates to products used in conventional methods of rasping or floating teeth using hand tools and precision specialty blades for rapid removal of points and edges on patient's teeth. The in-house manufactured blades and specialized equipment provide value and results to enhance the veterinarian's work and owner satisfaction.



USI/BSI (Universal Surgical Instruments and Better Surgical Instrumentation) provides high quality German and USI Midline instruments at an economical price within the veterinary industry. USI/BSI offers general and specialty instruments for veterinary practices including exotics, dental, ophthalmic and orthopedic instruments.



Ultima Dental Systems has spent more than 30 years innovating and manufacturing air driven dental systems for companion animals. Ultima continues to seek improved techniques to enhance veterinary dental care and service with the recent introduction of the new Ultima electric dental unit. Service and support remain our goal for clinic success.



Sentier is committed to providing powerful state-of-the-art monitoring devices to allow veterinary teams to monitor patients from admission to discharge increasing efficiency and patient safety. We are committed to the success of every monitoring situation while exceeding the standard for customer care and innovation. Vetcorder™ monitors are serviced in the US as we continue to develop solutions for the veterinary profession. With Vetcorder™ in your pocket, it is easy to monitor every patient, every time!

BRANDS & MANUFACTURERS



VetWelding AG is a Swiss veterinary orthopedic company established in 2017 with a vision to provide innovative options for treatment of trauma and degenerative disorders in the animal musculoskeletal system. VetWelding looks to bring new technologies into veterinary orthopedics. With a shared love of animals and the healing process, the team at VetWelding has come together to take veterinary medicine to the next level.



VSP (Veterinary Specialty Products LLC) began as a veterinarian-owned company nearly four decades ago and remains so today. VSP understands the challenges that exotic animal professionals face and focuses on developing exclusive, special-use products that can be used on a wide range of exotic pets, from birds and small mammals to reptiles and amphibians.

**GET WHAT YOU NEED...
STRAIGHT FROM THE HORSE'S MOUTH!**

Visit
maianimalhealth.com
to browse our selection.



TABLE OF CONTENTS

REPRODUCTION

Artificial Vaginas & Accessories	1-5
Canine Semen Collection & A.I.	6-7
Equine Semen Extenders	8
Sperm Concentration & IgG Kits	9-10
Semen Supplies	10-11
Culture Swabs	12
Cytology Brush & Uterine Speculum	13
Uterine Lavage / Flushing Supplies	14-15
Embryo Transfer Flushing Supplies	16
Infusion Pipettes & Pipette Protectors	17-18
Embryo Transfer Filters	19-20
Embryo Transfer Supplies	21-29
Syringes for E.T. / Semen & Accessories	30
Heat Detection	31-32
Lubricants	33
Sleeves	34-35
Obstetrical Instruments	36-37

DENTAL

SMALL ANIMAL

Dental Systems	39-45
Compressors & Accessories	46-47
Dental System Accessories	48-49
Piezoelectric Scaler & KLAW™ Tips	50
Handpieces	51-53
Burs	54-55
Dentanomic Instruments	56-58
Hand Instruments	59-63
Accessories	64
OnPointe™ Laser X-ray Guide	65

EQUINE

Powered Floats	67-72
Periodontal System & Accessories	73-74
Buccotomy & Dental Scope	75
Speculums & Accessories	76-77
Head Stands	78-79
Hand Instruments	80-92
Educational Accessories	93

ORTHOPEDICS

NEW!

BoneWelder® Vet System	95-100
------------------------------	--------

TABLE OF CONTENTS

SUTURES

Suture Cross-Reference Chart	101
Non-absorbable	102-104
Absorbable	104-107
Needle Reference Chart	108-109

SURGICAL INSTRUMENTS

Hemostats	111-112
Scissors	112-113
Needle Holders & Tissue Forceps.....	113
Instrument Kits & Miscellaneous	114-115

ENDOSCOPES

HD Video Endoscope System	117
Endoscope Instruments & Suction Unit.....	118
Aspiration Kits & Culture Swabs.....	119
Otoscopes	120
Aspiration & Irrigation	121
Flexible & Semi-Flexible Micro Endoscopes	122
Nasal Speculum & Rigid Endoscope.....	123
Transcervical & Laparoscopic Insemination.....	124

MONITORING

Vetcorder™ Pro Portable Patient Monitor	125
Vetcorder Airmate™ Capnograph	126
Vetcorder™ Pro + Vetcorder Airmate™ Combo	127
Blood Pressure Monitoring	128

SPECIALTY

Aspiration / Resuscitation & Accessories	129-133
Anesthesia Chambers	134
Fluid Delivery - Oral.....	135-137
Calf Feeders	138-139
Fluid Delivery - Oral for Calves	140
Fluid Delivery - IV	141-143
Fluid Delivery - Enema	144
Teat Care.....	145-147
Restraint Chambers & Management.....	148-150
Ruminant Specialty	151-152

SPECIALTY

Diagnostic.....	153-161
Wound Management - Small & Large Animal	162-163
First Aid	164-166
Consumer Products.....	167-168
Clinical Use.....	169
Large Animal Specialty.....	170
Signage	171-178
Client Education	178-179

MEDICANT INSTRUMENTS

Syringes & Syringe Accessories	181-182
Draw-Off Caps	183-184
Topical / Oral Delivery	185-186
Oral & Injection Delivery	187-189
Fluid Delivery Accessories	190
Water Delivery Systems	191-193
Dosing Delivery Systems	194-195
High Volume Delivery.....	196-201
Stomach Pump & Accessories	202
Bolus Guns.....	203-204
Microchip Delivery	205

NUTRITIONALS

Production Animal	207-208
-------------------------	---------

CONTAINERS

Syringes.....	209-210
Syringe Accessories	211-212
Back Pack Accessories	213
Bottles & Accessories	214-216
Rigid & Flexible Containers	217

NEW PRODUCTS

REPRODUCTION

Deep Chamber A.I. Catheters with Inner Straw - Page 17



AccuBreed™ Cloud Electronic Heat Detection System - Page 31



Bovine Long Y-Junction - Page 15



Equine Long Y-Junction - Page 16



DENTAL

Dentanomic Equine Luxation Blades & Contra Angles - Page 83



Ultima 600 - Page 42



Versa LED High Speed Handpiece - Page 52



NEW PRODUCTS

DENTAL

Dentanomic Gold, Silver & Bronze Dental Packages - Page 56



Equine Dental Scope System - Page 75



EEZY-MaXX™ Reciprocating Float - Page 69



ORTHOPEDIC

BoneWelder® Vet System - Page 95-100

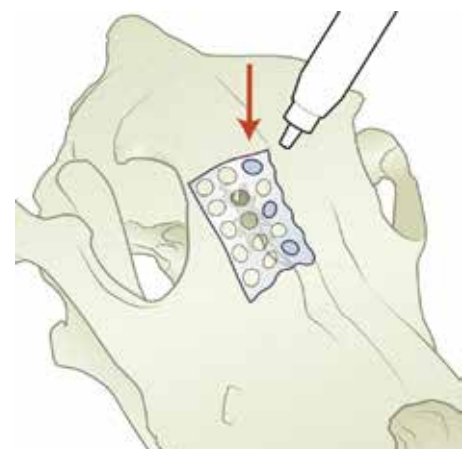

NEW PRODUCTS

ENDOSCOPES



Bi-Valve Nasal Speculum - Page 123



SPECIALTY

Umbilical Clamp, Puppy - Page 151



MaxLatch™ Clip-on Kennel Bowl - Page 167



EEZY-View™ LED Rechargeable Headlight - Page 159



MEDICANT INSTRUMENTS



Select Doser™ 380 - Page 191

Missouri Artificial Vagina & Accessories



- Kit includes: 16" or 22" latex A/V, leather jacket, two plastic 250 cc collection bottles, bottle adapter, semen filters, filling system, A/V conditioning solution and ten disposable inner liners
- Latex A/V Liner, 16" or 22"
- A/V filling valve air and water
- One-piece latex liner with tapered cone
- Leather jacket and reinforced handle assist in collection
- Fills with 3/8" Filling System or the E-Z A/V Filler
- Regular use of Conditioning Solution for A/V Liners will reduce bladder sticking and help prevent the growth of mold and mildew
- Approximate weight when full is 12 lbs



Item	Product Description	UOM
61629	22" Missouri A/V Complete Kit	Each
61622	Leather Jacket for 22" Missouri A/V	Each
61624	Latex Liner for 22" Missouri A/V	Each
17145	Disposable A/V Liner for 22" Missouri A/V	10/Bag
17147	Disposable A/V Liner with Filter for 22" Missouri A/V	10/Bag
17104	Insulated Neoprene A/V Cover for 22" Missouri A/V	Each
61630	16" Missouri A/V Complete Kit	Each
61625	Latex Liner 16" Missouri A/V	Each
61623	Leather Jacket for 16" Missouri A/V	Each
61635	Disposable A/V Liner with Filter for 16" Missouri A/V	10/Bag
61636	Disposable A/V Liner for 16" Missouri A/V	10/Bag
17105	Insulated Neoprene A/V Cover for 16" Missouri A/V	Each
17120	Insulated Bottle Cover for Missouri A/V	Each
17135	3/8" Filling System for Missouri A/V	Each
61626	Semen Collection Bottle Missouri / Har-Vet™ A/V - 250 cc	2/Bag
61631	Bottle Adapter for Missouri A/V	Each
61642	A/V Semen Filter - 6" x 2-1/4"	25/Bag
17140	E-Z A/V Filler	Each

Storage & Care of Missouri A/V Liners

- NEVER expose to petroleum-based products
- Do not stretch or fold during storage
- Store in a COOL, DARK, DRY location

Cleaning of Latex Rubber

- DO NOT use harsh detergents, antibacterial or degreaser soaps. Use non-ionic soap
- RINSE WELL
- DRY latex rubber immediately! Remove all water from the bladder. Hang the liner to dry. Remove water stem while drying

Equine A/V is guaranteed free from defects for 90 days from the ship date.

Colorado Artificial Vagina & Accessories



- Kit includes: A/V housing, water jacket liner, ten 7" strong securing bands, four plastic 250 cc collection bottles, 25 semen filters, water filling system and ten disposable inner liners
- 22-1/2" rigid one-piece plastic housing with handle
- Housing has a large 6" inner diameter
- A/V filling valve air and water
- Fills with the 1/2" Filling System or the E-Z A/V Filler
- Approximate weight when full is 25 lb

Item	Product Description	UOM
61645	Colorado A/V Complete Kit	Each
61644	Housing Only for Colorado A/V	Each
61646	Latex Water Jacket Liner for Colorado A/V	Each
17035	Latex Collection Liner with Flared End for Colorado A/V	Each
17137	1/2" Filling System for Colorado A/V	Each
61648	7" Rubber Band for Colorado A/V	10/Bag
61649	Disposable A/V Liner without Filter for Colorado A/V	10/Bag
61660	Disposable A/V Liner with Filter & Bottle for Colorado A/V	10/Bag
61642	A/V Semen Filter - 6" x 2-1/4"	25/Bag
17140	E-Z A/V Filler	Each
17121	Protective Cone - Colorado A/V	Each
61626	Semen Collection Bottle Missouri / Har-Vet™ A/V - 250 cc	2/Bag



Har-Vet™ Artificial Vagina & Accessories

- Kit includes: A/V housing, one latex water jacket liner, two sets of strong securing bands, two plastic 250 cc collection bottles, 25 semen filters, ten disposable inner liners and instruction manual
- Similar size to the Japanese A/V; housing inside diameter 4-3/4"
- 22-1/2" rigid one-piece plastic housing with handle
- Metal filling port allows for rapid filling
- Approximate weight when full is 8 lbs



Item	Product Description	UOM
61602	Har-Vet™ A/V Complete Kit	Each
61600	Har-Vet™ A/V Housing Only	Each
61603	Har-Vet™ Latex Water Jacket Liner	Each
61606	Har-Vet™ Disposable A/V Liner - Open End	10/Bag
61609	Har-Vet™ Rubber Band - Large	2/Bag
61610	Har-Vet™ Rubber Band - Small	2/Bag
61626	Semen Collection Bottle Missouri / Har-Vet™ A/V - 250 cc	2/Bag
61642	A/V Semen Filter - 6" x 2-1/4"	25/Bag
61607	Whirl Pak® Collection Bag, 18 oz	10/Bag

Disposable Artificial Vagina Kit

- Kit includes: 20" outer housing, inner vinyl liner, four filters, one plastic 250 cc collection bottle, four cable ties and four clamps to close water filling stem
- Housing inside diameter 6"
- Inner bladder is made of soft vinyl and is attached to the housing
- Inner bladder is to fill with water
- Ideal for limited use in clinics or stables
- Collection same as a Colorado, Har-Vet™, Missouri or Japanese A/V
- Designed for single use to prevent the possibility of disease transfer
- Single use item



Item	Product Description	UOM
61640	Disposable Equine A/V Kit	Each

Pony / Mini Artificial Vagina Complete Kit

- Kit includes: rubber A/V housing, leather jacket with handle, one latex water liner, ten disposable liners with filters, two strong securing bands, jug pump and a water filling system
- A/V filling valve for air and water
- Fills with the 1/2" Filling System or the E-Z A/V Filler
- Housing is 12" long with a 4" inside diameter
- For use with ponies and miniature stallions



Item	Product Description	UOM
17026	12" Pony / Mini A/V Complete Kit	Each
17106	Leather Jacket for Pony / Mini A/V	Each
17107	Latex Inner Liner for Pony / Mini A/V	Each
17109	Disposable A/V Liner with Filter for Pony / Mini A/V	10/Bag
17111	Disposable A/V Liner without Filter for Pony / Mini A/V	10/Bag
61626	Semen Collection Bottle Missouri / Har-Vet™ A/V - 250 cc	2/Bag
61642	A/V Semen Filter - 6" x 2-1/4"	25/Bag
17135	1/2" Filling System for Missouri A/V	Each
15800	A/V Air Filling Jug Pump	Each
17140	E-Z A/V Filler	Each



Standard Bovine Artificial Vagina Complete

- Complete A/V includes: optional size housing fitted with a screw cap water filling valve, one latex inner liner, two strong securing bands, one latex director cone and one graduated semen collection vial
- Housing made of high quality black rubber tubing with 2-3/4" inside diameter

Item	Product Description	UOM
14706	Standard 14-1/2" Bovine A/V Complete	Each
14701	Standard 14-1/2" Bovine A/V Housing Only with Filling Valve	Each
14705	Standard 16-1/2" Bovine A/V Complete	Each
14700	Standard 16-1/2" Bovine A/V Housing Only with Filling Valve	Each



Deluxe Bovine Artificial Vagina Complete

- Complete A/V includes: 16-1/2" housing, one latex inner liner, two strong securing bands, one latex director cone, one graduated semen collection vial and one water filling valve
- Housing made of molded rubber with optimal rigidity
- Smooth finish inside and out
- Rounded ends allow easy cleaning
- 5/8" water filling hole fitted with screw cap water filling valve

Item	Product Description	UOM
14709	Deluxe 16-1/2" Bovine A/V Complete	Each
14708	Deluxe 16-1/2" Bovine A/V Housing Only with Filling Valve	Each
14707	Deluxe 16-1/2" Bovine A/V Housing Only	Each



Bovine Artificial Vagina Accessories

Item	Product Description	UOM
14610	Inner Liner, Smooth Surface Latex - 23"	Each
14651	Semen Collection Cone, Latex - 10" without Vent	Each
14655	Semen Collection Cone, Disposable Plastic - 11"	100/Box
50014	Semen Collection Cone, Disposable Plastic - 14"	25/Bag
14657	Disposable A/V Liner, 20" Bovine	10/Bag
17140	E-Z A/V Filler	Each
17142	Economy A/V Filler	Each
49101	A/V Disposable Collection Centrifuge Vial - 15 ml	100/Box
14800	A/V Filling Valve - Air & Water	Each
14710	A/V Filling Valve Screw Cap	Each
15800	A/V Air Filling Jug Pump	Each



Ovine Artificial Vagina Complete & Accessories

- Complete A/V includes: 8" rubber A/V housing with a 2-1/4" inside diameter, air and water valve, one latex inner liner, one latex collection liner, two strong securing bands, one graduated semen collection vial and one jug pump

Item	Product Description	UOM
15010	Sheep A/V Complete	Each
15005	Sheep A/V Housing Only with Filling Valve	Each
15004	Sheep A/V Housing Only	Each
15011	Sheep A/V Inner Liner	Each



Conditioning Solution for Artificial Vagina Liners

- For use inside the bladder of the Missouri Latex Liner to prevent sticking
- Aids in the prevention of mold and mildew growth

Item	Product Description	UOM
17100	A/V Conditioning Solution - 4 oz	Each



Artificial Vagina Semen Filter

- Fits any A/V using a baby bottle for collection including Har-Vet™, Missouri, Colorado, Disposable and Pony A/V
- Used to remove debris, non-semen or seminal fluids from the ejaculate, leaving whole semen for laboratory evaluation and A.I. procedures
- Low cost
- Single use item

Item	Product Description	UOM
61642	A/V Semen Filter - 6" x 2-1/4"	25/Bag



Semen Collection Bottle

Item	Product Description	UOM
61626	Semen Collection Bottle Missouri / Har-Vet™ A/V - 250 cc	2/Bag



E-Z Artificial Vagina Filler

- Fits onto hose attachment
- Easy to use without getting wet
- Quick release connector for easy attachment
- Brass fittings
- Fits most A/Vs

Item	Product Description	UOM
17140	E-Z A/V Filler	Each



Economy Artificial Vagina Filler

Item	Product Description	UOM
17142	Economy A/V Filler	Each



Hanger for Latex Liner

- For use in properly drying and storing latex liners

Item	Product Description	UOM
17101	Hanger for Latex Liner	Each



Valve for Air / Liquid Core Housing

- Replacement filling valve for Missouri, Colorado and Mini A/V

Item	Product Description	UOM
17800	Valve for Air / Liquid Core Housing	Each



Alconox® Detergent Powder

- Concentrated detergent for removing organic contaminants
- May be used on soft metals and latex rubber

Item	Product Description	UOM
17103	Alconox® Detergent Powder, 4 lbs	Each



“The Tickler”™ CGS Electrojector

- Includes Electronic Control Unit fitted with vinyl protective jacket, Standard Bull Probe, Ram Probe, SLA battery charger and carrying case
- 12-Volt battery lead available
- Various probes available - bull or ram

Item	Product Description	UOM
14900	“The Tickler”™ - Electronic Control Unit (EJ6CR7) - CGS Ejaculator Kit	Each
14901	12V Battery Lead	Each
14902	12V US Battery Charger	Each
14903	Ram Probe	Each
14907	Standard Bull Probe	Each
14905	Dual Mode Bull Probe	Each
14909	Multi Mode Bull Probe	Each



Canine Semen Collection & Artificial Insemination Kit

Complete kit for the collection of canine semen.

Kit includes one each:

- Latex collection cone and 15 cc graduated vial
- Disposable 5 cc syringe
- 4" insemination pipette for small dogs
- 9" insemination pipette for large dogs
- Pair of disposable gloves
- Package of lubrication jelly
- Single use item



Item	Product Description	UOM
19250	Canine Semen Collection & Artificial Insemination Kit	Each

Canine Disposable A/V Liner Kit & Collection Cones

A/V Liner Kit includes a disposable liner made of 2.5 mil polyethylene film attached to a 15 cc graduated vial. It may be used as a collection cone or as a liner inside a collection cone.

- Single use item



Item	Product Description	UOM
50015	Canine Disposable A/V Liner Kit	10/Bag
50014	Semen Collection Cone, Disposable Plastic - 14", 2.5 mil	25/Bag
14655	Semen Collection Cone, Disposable Plastic - 11", 3 mil	100/Box
14650	Semen Collection Cone, Latex - 10" with Vent	Each
14651	Semen Collection Cone, Latex - 10" without Vent	Each

Tie-Up™ Canine Intravaginal A.I. Kits PATENTED

- Soft, plastic coated sponge simulates male penis, triggering normal physiological events in the female canine that occur during actual breeding
- After insertion, female's vaginal contractions close down on sponge simulating actual "tying up"
- A.I. catheter runs through center of vaginal delivery device. Proximal end has non-traumatic STIP™ Tip and distal end has flex tip for syringe or cap attachment
- Vaginal contractions on sponge hold sponge in place and stop semen leakage; the contractions aspirate the semen into the uterine body cavity simulating the natural act
- Kit includes: canine disposable A/V liner, 15 cc graduated vial, Pro-Ject™ 2-Piece Syringe, Luer Slip Tip, 15 cc (Gamma Irradiated) (Item # 60020) and Canine Intravaginal A.I. Device
- Three sizes available: 2", 4" and 6" individually or in kits
- Available non-sterile or gamma irradiated
- Single use item



Item	Product Description	UOM
18200-2	Tie-Up™ Canine Intravaginal A.I. Kit, 2"	Each
18200-4	Tie-Up™ Canine Intravaginal A.I. Kit, 4"	Each
18200-6	Tie-Up™ Canine Intravaginal A.I. Kit, 6"	Each
18206-2	Tie-Up™ Canine Intravaginal A.I. Device, 2" - Gamma Irradiated	5/Bag
18206-4	Tie-Up™ Canine Intravaginal A.I. Device, 4" - Gamma Irradiated	5/Bag
18206-6	Tie-Up™ Canine Intravaginal A.I. Device, 6" - Gamma Irradiated	5/Bag
18205-2	Tie-Up™ Canine Intravaginal A.I. Device, 2" - Non-Sterile	5/Bag
18205-4	Tie-Up™ Canine Intravaginal A.I. Device, 4" - Non-Sterile	5/Bag
18205-6	Tie-Up™ Canine Intravaginal A.I. Device, 6" - Non-Sterile	5/Bag



Infusion Pipettes

Single use pipette, individually packaged for canine artificial insemination. Pipette is 4" or 9" long with flex tip adapter to fit a syringe.

- Individually packaged
- Gamma irradiated or EtO exposed
- Single use item

Item	Product Description	UOM
26600	Infusion Pipette, 4" with Flex Tip - Gamma Irradiated	12/Bag
19020	Infusion Pipette, 9" with Flex Tip - Gamma Irradiated	25/Bag



STIP™ Tip Canine Insemination Pipettes

Single use pipette with STIP™ Tip smooth bulb end allows for less traumatic passage of pipette without complication. Tapered tip prevents back vacuum of semen when withdrawing the pipette. Narrow outlet port is attached to a 4" or 10" pipette to deliver semen further into anterior vagina. Flex tip adapter fits onto syringe.

- Individually packaged
- Gamma irradiated or EtO exposed
- Single use item

Item	Product Description	UOM
50405	STIP™ Tip Canine Insemination Pipette, 4"	12/Bag
50400	STIP™ Tip Canine Insemination Pipette, 10"	25/Bag



Canine Bullet Tip Culture Swab

- Designed specifically for use in canines
- 14" double-guarded swab consists of an outer soft PVC sleeve with 'X' - perforated tip covering inner tubular guard which houses the calcium alginate swab style collection tip
- Assists in preventing outside contaminants from affecting the sample
- Individually packaged
- Gamma irradiated or EtO exposed
- Single use item

Item	Product Description	UOM
50020	Canine Bullet Tip Culture Swab	25/Bag



Kenney Canine Semen Extenders

Kenney Skim Milk Canine Semen Extenders provide the user with the following advantages:

- Prevents agglutination of spermatozoa so forward motility can be determined
- Canine semen extender with gentamicin helps destroy infectious pathogens
- Buffers the pH of antibiotics added to the semen
- Maintains a higher percent of forward motility over time as compared to raw semen
- Increases the insemination dose volume making it easier to handle and minimizing spermatozoa loss in equipment such as insemination pipettes
- Packaged in moisture proof foil to ensure stable and long-lasting shelf life
- Allows for storage of cooled semen for use up to 48 hours after collection

Item	Product Description	UOM
50420	Canine Semen Extender without Antibiotics - Non-Returnable	Each
50423	Canine Semen Extender with Gentamicin - Non-Returnable	Each



INRA 96 Semen Extender

- Pre-mixed ready to use liquid
- Ideal for problem stallions
- Contains Gentamicin, Penicillin and Amphotericin B
- Store refrigerated for up to one week after opening
- Sterile



Item	Product Description	UOM
17553	INRA 96 Semen Extender, 200 ml - Non-Returnable	Each

Har-Vet™ Semen Extenders & Accessories

- Prevents agglutination of spermatozoa so forward motility can be determined
- Helps destroy infectious pathogens when an antibiotic has been added
- Buffers the pH of antibiotics added to the semen
- Maintains a higher percent of forward motility over time as compared to raw semen
- Increases the insemination dose volume making it easier to handle and minimizing spermatozoa loss in equipment such as insemination pipettes
- Allows for storage of cooled semen for use up to 48 hours after collection
- Semen extender and sterile-filtered water available as a kit or sold separately
- Packaged in moisture proof foil to ensure stable and long-lasting shelf life



Item	Product Description	UOM
01500	Har-Vet™ Semen Extender Kit with Gentamicin Sulfate - Non-Returnable	Each
01501	Har-Vet™ Semen Extender with Gentamicin Sulfate - Powder Only - Non-Returnable	Each
01502	Har-Vet™ Semen Extender Kit with Amikacin & Potassium Penicillin - Non-Returnable	Each
01503	Har-Vet™ Semen Extender with Amikacin & Potassium Penicillin - Powder Only - Non-Returnable	Each
01510	Har-Vet™ Semen Extender Kit without Antibiotics - Non-Returnable	Each
01511	Har-Vet™ Semen Extender without Antibiotics - Powder Only - Non-Returnable	Each
01520	Har-Vet™ Semen Extender Kit with Ticarcillin - Non-Returnable	Each
01521	Har-Vet™ Semen Extender with Ticarcillin - Powder Only - Non-Returnable	Each
01525	100 ml Bottled Water for Semen Extender Powder - Sterile-Filtered	25/Box
01526	92 ml Bottled Water for Semen Extender Powder - Sterile-Filtered	25/Box



Original DVM Rapid Test™ I Analyzer Tests



Item	Product Description	UOM
49500	IgG Serum / Plasma Test Kit - Equine - for Original DVM Rapid Test™ I, Non-Returnable, Refrigerate	12/Box
49505	IgG Colostrum Test Kit - Equine - for Original DVM Rapid Test™ I, Non-Returnable, Refrigerate	12/Box
49530	IgG Serum / Plasma Test Kit - Camelid- for Original DVM Rapid Test™ I, Non-Returnable, Refrigerate	12/Box
49550	IgG Serum / Plasma Test Kit - Bovine - for Original DVM Rapid Test™ I, Non-Returnable, Refrigerate	12/Box
49555	IgG Colostrum Test Kit - Bovine - for Original DVM Rapid Test™ I, Non-Returnable, Refrigerate	12/Box
49510	Sperm Concentration Test - Bovine, Equine & Porcine - for Original DVM Rapid Test™ I	25/Box
49511	Sperm Concentration Test - Bovine, Equine & Porcine - for Original DVM Rapid Test™ I	125/Box
49512	Sperm Concentration Test - Bovine, Equine & Porcine - for Original DVM Rapid Test™ I	1,000/Box
49514	Sperm Concentration Test - Canine - for Original DVM Rapid Test™ I	25/Box
49509	Sperm Concentration Reagent - 25 ml - for Original DVM Rapid Test™ I	Each
49513	Sperm Concentration Reagent - 100 ml - for Original DVM Rapid Test™ I	Each
49586	Primary Turbidity Standards Kit - for Original DVM Rapid Test™ I	Each

DVM Rapid Test™ II - Analyzer



- Portable, turn key and battery-operated handheld analyzer kit
- Lightweight portable case contains all components required to perform test
- Low cost and simple to operate
- All tests may be performed in 10 minutes or less
- Proven accuracy
- Simple, one-step test procedure
- Direct reading of results; no charts needed
- Test kits sold separately
- Optional infrared router for transferring data to computer
- **DVM Rapid Test™ II - Multi-Test Analyzer Tests:**
 - ◆ Serum / Plasma IgG - Bovine, Equine and Camelid
 - ◆ Colostrum IgG - Bovine and Equine
 - ◆ Sperm Concentration - Equine
- **DVM Rapid Test™ II - Sperm Concentration Analyzer Tests:**
 - ◆ Sperm Concentration - Equine, Bovine, Porcine and Canine



Item	Product Description	UOM
49030	DVM Rapid Test™ II - Multi-Test Analyzer	Each
49035	DVM Rapid Test™ II - Sperm Concentration Analyzer	Each
49586-1	Primary Turbidity Standards Kit - for DVM Rapid Test™ II	Each

* Test Kits and Pipette Tips sold separately.

IgG Serum / Plasma & Colostrum Test Kits - Equine

Item	Product Description	UOM
49500-1	IgG Serum / Plasma Test Kit - Equine - Non-Returnable, Refrigerate	12/Box
49505-1	IgG Colostrum Test Kit - Equine - Non-Returnable, Refrigerate	12/Box

IgG Serum / Plasma & Colostrum Test Kits - Bovine

Item	Product Description	UOM
49550-1	IgG Serum / Plasma Test Kit - Bovine - Non-Returnable, Refrigerate	12/Box
49555-1	IgG Colostrum Test Kit - Bovine - Non-Returnable, Refrigerate	12/Box

IgG Serum / Plasma Test Kit - Camelid

Item	Product Description	UOM
49530-1	IgG Serum / Plasma Test Kit - Camelid - Non-Returnable, Refrigerate	12/Box

Tip:

Use the
DVM Rapid Test™ II Router
to easily transfer
data from the
DVM Rapid Test™ II
to a computer!





Sperm Concentration Test - Equine, Bovine, Porcine & Canine

Item	Product Description	UOM
49510-1	Sperm Concentration Test - Equine, Bovine, Porcine & Canine	25/Box

DVM Rapid Test™ II Router

Item	Product Description	UOM
49034	DVM Rapid Test™ II Router	Each

Pipettors & Accessories



- Tips to be used with a pipettor
- Micropipettors for laboratory use

Minipet Pipettors

Item	Product Description	UOM
49011	Minipet Pipettor, 5 ul	Each
49012	Minipet Pipettor, 10 ul	Each
49013	Minipet Pipettor, 25 ul	Each
49015	Minipet Pipettor, 50 ul	Each



StatPet™ Micropipette

Item	Product Description	UOM
49020	StatPet™ Micropipette, 1,000 ul	Each



Micropipette Tips

- Single use item

Item	Product Description	UOM
49182	Micropipette Tips, 200 ul	96/Box
49183	Micropipette Tips, 1,250 ul	96/Box

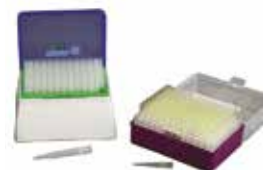

Cover Slips



- 22 mm x 22 mm
- No. 1 thickness

Item	Product Description	UOM
49001	Cover Slips	100/Box



Microscope Slides

- Clear glass
- Ground edges
- 3" x 1"
- 1 mm - 1.2 mm thickness

Item	Product Description	UOM
49000	Microscope Slides, 3" x 1"	72/Box



Centrifuge Vial / Tube

Item	Product Description	UOM
49101	A/V Disposable Collection Centrifuge Vial - 15 ml	100/Box
27845	Centrifuge Tube - 50 ml	50/Bag



Stallion Urinary Catheter

- Rounded tip with four side ports
- Accepts oral syringe or foley tip syringes
- Outside diameter .285"
- Length 54"
- Individually packaged and gamma irradiated or EtO exposed
- Rigid stylet for ease in insertion
- Single use item

Item	Product Description	UOM
21405	Stallion Urinary Catheter	Each



VIP Impact™ Specimen Shipper

- Cost effective method of shipping fresh cooled semen and other temperature sensitive items
- Smaller than average overall dimensions resulting in less expensive shipping options
- Contains three mini phenolic packs and two specimen carriers to accommodate syringes, centrifuge tubes or bags
- Environmentally friendly insulated material (non-polystyrene)
- Outer box is a bold green color to stand out in priority shipments

Item	Product Description	UOM
17820	VIP Impact™ Specimen Shipper	Each



Stallion Condom

- Latex
- 12-3/4" long, 5-3/4" wide at base and 3-3/8" wide at top opening
- .0125" wall thickness at open end

Item	Product Description	UOM
61650	Stallion Condom	Each



Uterine Culture Swabs

There are various methods and instruments used to culture the uterus of any large animal. The uterine culture swab is made of calcium alginate and is used primarily in equine, however is effective in all species. Calcium alginate is a special medical grade media which is soluble in body fluids. It minimizes the risk of reddening or irritation during the collection process that may be caused by the fiber particles in other culture swabs. The swab stick is designed to minimize head loss or stick breakage in the uterus. Guarded swabs have a secure scored cap or outer body that has a secondary rigid tube within the primary shaft which protects the inner swab and shaft. All swabs are single use items, individually packaged and gamma irradiated or EtO exposed.

Tieglund Uterine Culture Swab with Soft Sheath

- 30" swab with outer tube and double-guarded with a plastic sheath
- Sheath is easily penetrated after passing through the cervix
- Calcium alginate fiber head for low pathogen toxicity
- Swab length is easily reduced for transport and plating
- Single use item



Item	Product Description	UOM
17705	Tieglund Uterine Culture Swab with Soft Sheath	25/Bag

Tieglund Uterine Culture Swab

- 30" swab is single-guarded by an outer tube
- Calcium alginate fiber head for low pathogen toxicity
- Swab length is easily reduced for transport and plating
- Single use item



Item	Product Description	UOM
64400	Tieglund Uterine Culture Swab	25/Bag

Double-Guarded Uterine Culture Swab with Calcium Alginate Tip

PATENTED

- 30" swab is double-guarded with a rigid outer shell
- Calcium alginate fiber head for low pathogen toxicity
- Swab length is easily reduced for transport and plating
- Single use item



Item	Product Description	UOM
64300	Double-Guarded Uterine Culture Swab with Calcium Alginate Tip	25/Bag

Bullet Tip Capped Culture Swab with Calcium Alginate Tip

- 30" swab is single-guarded by the capped outer tube
- Calcium alginate fiber head for low pathogen toxicity
- Swab length is easily reduced for transport and plating
- Once swab is extended, the hinged cap may also be used for sample collection
- Single use item



Item	Product Description	UOM
17715	Bullet Tip Capped Culture Swab with Calcium Alginate Tip	25/Bag



Double-Guarded Cytology Brush & Culture Swab Combination

- 31" stick double-guarded with a rigid outer shell
- Nylon brush removes easily for cytology
- Obtain cytology and/or culture samples in one easy application
- Calcium alginate fiber head for low pathogen toxicity
- Less trauma to the uterus and decreases pathogen introduction
- Easily reduced for transport and plating
- Single use item

Item	Product Description	UOM
17726	Double-Guarded Cytology Brush	25/Bag
17725	Double-Guarded Cytology Brush Culture Swab Combination	25/Bag



Uterine Speculum

Speculums are used to protect culture swabs, pipettes and any instrument used in uterine procedures, preventing vaginal contamination during entry. Each speculum has an extra heavy wall to prevent collapse with a rounded end to prevent insertion trauma. Individually packaged and available non-sterile or gamma irradiated.

- 18" long x 1-3/8" outer diameter
- Silver inside and out
- Rounded end is lightly lubricated
- Single use item

Item	Product Description	UOM
63510	Uterine Speculum, Gamma Irradiated	50/Box



Single Line Uterine Lavage Tubing

- Length 60"
- Large diameter or conventional sized tubing with foley adapter at one end and a non-vented spike at the opposite end to penetrate media bags or bottles
- Attaches to a large bore pipette or foley catheter
- Individually packaged and gamma irradiated or ETO exposed
- Available in two diameters, rapid and regular flow
- Single use item

Item	Product Description	UOM
17410	Single Line Lavage Tubing, Rapid Flow - .300" Inside Diameter	Each
63625	Single Line Lavage Tubing - .201" Inside Diameter	Each



Uterine Flush with Enema Tip

Item	Product Description	UOM
24025	Uterine Flush with Enema Tip	Each



Uterine Flushing Catheter

- Length 72"
- Large bore tubing with side eyelets and open end to enable complete flushing
- Non-vented spike to connect to a bag
- Halkey-Roberts® clamp to regulate flow rate
- Individually packaged and gamma irradiated or EtO exposed
- Single use item

Item	Product Description	UOM
21410	Uterine Flushing Catheter	Each



Simplex Uterine Flushing Catheter

- Length 75"
- Large bore tubing for rapid flow
- Large bore tubing with open end to enable complete flushing
- Vented funnel for large animal fluid administration
- Funnel opening is 2.6 cm inside diameter that stretches to fit over most common size bottle necks
- Halkey-Roberts® clamp to regulate flow rate
- Individually packaged and EtO exposed
- Single use item

Item	Product Description	UOM
16300	Simplex Uterine Flushing Catheter	Each



Simplex Funnel with Foley Adapter

- Length 72"
- Large bore tubing for rapid flow
- Vented funnel for large animal fluid administration
- Funnel opening is 2.6 cm inside diameter that stretches to fit over most common size bottle necks
- Foley adapter
- Halkey-Roberts® clamp to regulate flow rate
- Individually packaged and gamma irradiated or EtO exposed
- Single use item

Item	Product Description	UOM
39020	Simplex Funnel with Foley Adapter	Each



Silicone Foley Catheters & Accessories

- Used for flushing / irrigation, medication administration and embryo collection / transfer
- Inflatable balloon
- Silicone resists deterioration and is completely inert
- Soft and pliable
- Individually packaged and gamma irradiated

Item	Product Description	UOM
21360	Silicone Flushing Catheter, 28FR, 75 cc Balloon, 2 Eyelets, Bullet Tip End - 135 cm	Each
21362	Silicone Flushing Catheter, 34FR, 100 cc Balloon, 2 Eyelets, Open End - 80 cm	Each
21364	Silicone Flushing Catheter, 34FR, 100 cc Balloon, 2 Eyelets, Open End - 160 cm	Each
03940	Stepped Adapter / Tubing Connector	Each



HALKEY-ROBERTS is a registered trademark of Halkey-Roberts Corporation.



Y-Junctions



- Ideal for embryo transfer and uterine flushing / lavage
- 4" inflow tube connects to either a Foley or Rusch catheter
- Constructed of medical grade PVC tubing
- Star design tubing reduces kinking and works well in cold weather
- Individually packaged and gamma irradiated or EtO exposed
- Single use item

Short Y-Junction with Foley Adapter & Syringe Connector

Item	Product Description	UOM
04130	Short Y-Junction with Foley Adapter & Syringe Connector - 30"	Each



Long Y-Junction with Foley Adapter & Spike Connector

Item	Product Description	UOM
04132	Long Y-Junction with Foley Adapter & Spike Connector - 60"	Each



Rapid Flow Y-Junction with Foley Adapter & Spike Connector

- Large bore tubing
- Large bore spike for rapid flow

Item	Product Description	UOM
24010	Rapid Flow Y-Junction with Foley Adapter & Spike Connector - 60"	Each



Long Rusch Y-Junction with Spike

Item	Product Description	UOM
04134	Long Rusch Y-Junction with Spike - 60"	Each



Short Rusch Y-Junction with Syringe Adapter

Item	Product Description	UOM
04131	Short Rusch Y-Junction with Syringe Adapter - 30"	Each



Long Y-Junction with Foley Adapter & Large Bore Spike

Item	Product Description	UOM
04133	Long Y-Junction with Foley Adapter & Large Bore Spike - 60"	Each



Bovine Long Y-Junction



Item	Product Description	UOM
24014	Bovine Long Y-Junction - 67"	Each



Equine Long Y-Junction

Item	Product Description	UOM
24016	Equine Long Y-Junction - 67"	Each

Syringe Flush with Foley Connector - Short

Item	Product Description	UOM
24017	Syringe Flush with Foley Connector - Short	Each

Syringe Flush with Foley Connector - Long

Item	Product Description	UOM
24018	Syringe Flush with Foley Connector - Long	Each

Y-Junction Uterine Flush with Enema Tip

Item	Product Description	UOM
24025	Y-Junction Uterine Flush with Enema Tip	Each

Extension Set with Syringe Adapter & Spike

Item	Product Description	UOM
24050	Extension Set with Syringe Adapter & Spike, 16"	Each

Syringe to Catheter Connector

Item	Product Description	UOM
24052	Syringe to Catheter Connector, 16"	Each

3 Way Valve

Item	Product Description	UOM
24055	3 Way Valve - Dual Check Valve with Female Luer Lock Top & Spin-Lock	Each

Flush Bag with Y-Junction

- Ideal for uterine flushing / lavage
- Zipper closure with wide opening makes filling easy
- Long Y-Junction with foley adapter connected to bag
- 4" inflow tube connects to foley catheter
- Individually packaged and gamma irradiated or EtO exposed
- Single use item

Item	Product Description	UOM
04124	Flush Bag with Y-Junction - 2-1/2 Liter	Each
24100	Flush Bag with Y-Junction - 6 Liter	Each



Equine Artificial Insemination & Infusion Kits

These kits include a sleeve and an insemination pipette, with or without a syringe, and are used in artificial insemination of a mare. Individually packaged and gamma irradiated.

Infusion Kit includes: one 21" insemination pipette with flexible syringe adapter and one sleeve.

Artificial Insemination Kit includes: one 21" insemination pipette with flexible syringe adapter, one sleeve and one all plastic, non-spermicidal 60 cc syringe.

- Single use item



Item	Product Description	UOM
19524	Infusion Kit with Yellow Sof™ Sleeve	10/Bag
19525	Infusion Kit with Ultra-Sens™ Sleeve	10/Bag
19526	Artificial Insemination Kit with 60 cc Syringe	10/Bag

Deep Chamber Artificial Insemination Catheters

- Deep horn insemination
- Flexible shaft to follow curve of the horn
- Finger-grip control at plunger end
- STIP™ Tip bulb end
- Ease in passing through cervix
- Length 29-3/4"
- Individually packaged and gamma irradiated or EtO exposed
- Single use item



Item	Product Description	UOM
27525	Deep Chamber A.I. Catheter, 1 Exit Port	Each
27526	Deep Chamber A.I. Catheter, 2 Exit Port	Each
27528	Deep Chamber A.I. Catheter, End Delivery, 1 Exit Port, Blue Tip with Inner Straw for 1/4 & 1/2 cc Straws	Each
27529	Deep Chamber A.I. Catheter, Side Delivery, 1 Exit Port, Yellow Tip with Inner Straw for 1/4 & 1/2 cc Straws	Each
27840	Extraction Stylet for 1/2 cc Straws	Each

Equi-Flex Pipette with Tube Protector

- Used for deep horn insemination
- Flexible 30" insemination pipette
- Rigid pipette protector with die cut end cap reduces vaginal contamination
- Individually packaged and EtO exposed
- Single use item



Item	Product Description	UOM
31020	Equi-Flex Pipette with Tube Protector - 30"	25/Bag

HAVE YOU 'HERD' ABOUT OUR BRAND NEW WEBSITE?



Visit
maianimalhealth.com
 to browse all of our products.



Infusion Pipettes

Pipettes are made of PVC, designed to deliver medicants, semen or other materials through the cervix and into the uterus of an animal.

Large Bore Flex Tip Infusion Pipettes

- Accepts oral syringe or foley tip syringes
- Inside diameter is twice the size of a regular pipette
- Individually packaged and gamma irradiated or EtO exposed; bulk non-sterile
- Single use item



Item	Product Description	UOM
19058	Infusion Pipette, Flex Tip - 25" Large Bore, Bulk, Non-Sterile	25/Bag
19059	Infusion Pipette, Flex Tip - 25" Large Bore, Gamma Irradiated or EtO Exposed	25/Bag

Flex Tip Infusion Pipettes

The syringe adapter is a friction fit, flexible PVC tube attached to a pipette and accepts any luer lock or luer slip syringe.

- Rounded and polished entry tip to minimize tissue trauma
- Individually packaged and gamma irradiated or EtO exposed; bulk non-sterile
- Single use item



Item	Product Description	UOM
19031	Infusion Pipette, Flex Tip - 18", Bulk, Non-Sterile	25/Bag
19051	Infusion Pipette, Flex Tip - 21", Bulk, Non-Sterile	25/Bag
19052	Infusion Pipette, Flex Tip - 25", Bulk, Non-Sterile	25/Bag
19033	Infusion Pipette, Flex Tip - 18", Gamma Irradiated or EtO Exposed	25/Bag
19053	Infusion Pipette, Flex Tip - 21", Gamma Irradiated or EtO Exposed	25/Bag
19057	Infusion Pipette, Flex Tip - 25", Gamma Irradiated or EtO Exposed	25/Bag

Drilled Pipettes

The syringe adapter is drilled into the PVC tube and accepts any luer slip or luer lock syringe.

- Individually packaged and gamma irradiated or EtO exposed; bulk non-sterile
- Single use item



Item	Product Description	UOM
19030	Infusion Pipette, Drilled Tip - 18", Bulk, Non-Sterile	25/Bag
19050	Infusion Pipette, Drilled Tip - 21", Bulk, Non-Sterile	25/Bag
19035	Infusion Pipette, Drilled Tip - 18", Gamma Irradiated or EtO Exposed	25/Bag
19055	Infusion Pipette, Drilled Tip - 21", Gamma Irradiated or EtO Exposed	25/Bag

Pipette Protectors

Protector is used to protect pipette and A.I. equipment from vaginal contamination.

- Two-piece construction with cored tube at one end and scored cap at the opposite end
- Pipette and A.I. equipment penetrate through scored end
- Individually packaged and gamma irradiated
- Single use item



Item	Product Description	UOM
19065	Pipette Protector, Clear - 8"	25/Bag
19060	Pipette Protector, Blue - 8"	25/Bag
19064	Pipette Protector, Blue - 10"	25/Bag
19061	Pipette Protector, Blue - 12"	25/Bag
19063	Pipette Protector, Blue - 15"	25/Bag



Em Con™ Filter

- 75 micron stainless steel screen at base of filter
- Includes drain tube for controlling level of fluid in filter
- Individually packaged and gamma irradiated
- Single use item

Item	Product Description	UOM
04135	Em Con™ Filter	Each



Sure Flush™ Embryo Transfer Filter

- 74 micron nylon mesh filter
- Includes drain tube for controlling level of fluid in filter
- Vented single step system
- Individually packaged and gamma irradiated
- Single use item

Item	Product Description	UOM
23138	Sure Flush™ E.T. Filter	Each



MAI High Volume Embryo Transfer Filter

- 64 micron raised, cylindrical nylon filter
- Contoured base for embryos to settle in center of dish
- Upon completion of flush, reservoir will maintain approximately 120 ml of media
- Individually packaged and gamma irradiated
- Single use item

Item	Product Description	UOM
04136	MAI High Volume E.T. Filter	Each



Note:
Don't forget **Filter Warmers**
found on **page 23!**

MAI Low Volume Embryo Transfer Filter

- 64 micron cylindrical nylon filter
- Contoured base for embryos to settle
- Base may be used as searching dish
- Upon completion of flush, reservoir will maintain approximately 50 ml of media
- Individually packaged and gamma irradiated
- Single use item

Item	Product Description	UOM
04137	MAI Low Volume E.T. Filter	Each



IVF Oocyte Aspiration Dish

- Double well aspiration receiver
- Two 25 ml chambers
- Lid designed to rotate 360°
- Ability to have two separate and unique collections
- Ability to place warm media into void to maintain temperature
- Single use item



Item	Product Description	UOM
26500	IVF Oocyte Aspiration Dish	Each

Embryo Transfer Filter

- Angled filter along side wall
- Gridded bottom for embryo searching
- Individually packaged and gamma irradiated
- Single use item



Item	Product Description	UOM
25501	E.T. Filter	Each
25503	E.T. Filter with Y-Junction	Each

Em Con™ IVF Oocyte Filters

Designed for the aspiration, washing and filtering of oocytes in IVF procedures

- Available for 2 mm (Blue) and 3 mm (Red) needle tubing
- Color-coded filter caps prevent filter mix-up
- Cap has 2 inlet ports to connect the filter to the vacuum pump and the needle tubing
- Seal tight compression fitting for needle tubing prevents vacuum leakage
- Disposable, one time use filter provides a cost effective way to eliminate chemical and biological contamination between donors
- Economical, consistent, high quality plastic construction
- 75 micron stainless steel screen at base of filter
- Individually packaged and gamma irradiated
- Accessories available:
 - ◆ 2 mm and 3 mm needle tubing
 - ◆ Filter warmer with viewing window
- Single use item



Item	Product Description	UOM
26505	Em Con™ IVF Oocyte Filter for 3 mm Needle Tubing	Each
26507	Em Con™ IVF Oocyte Filter for 2 mm Needle Tubing	Each

E.T. Filter Cup

- Angled filter along side wall
- Gridded bottom for embryo searching
- Individually packaged and gamma irradiated
- Single use item

Item	Product Description	UOM
26515	E.T. Filter Cup with Grid - 3 mm Needle Tubing Vacuum Port - Red	Each



IVF Threaded Centrifuge Tube Cap

The IVF Threaded Centrifuge Tube Cap is designed for Ovum Pick-Up procedures using a centrifuge tube for oocyte collection.

- Compression fitting provides tight and secure connection for needle tubing
- Enhances biosecurity
- Cost effective
- Eliminates cleaning time and expense
- Prevents toxic residue left behind from cleaning / sterilization process
- Fits standard thread on commercial 50 ml centrifuge tubes (centrifuge tube not included)
- Single use item

Item	Product Description	UOM
26510	IVF Threaded Centrifuge Tube Cap with 3 mm Needle Tubing Vacuum Port - Red	Each
26512	IVF Threaded Centrifuge Tube Cap with 2 mm Needle Tubing Vacuum Port - Blue	Each



Em Con™ Embryo Filter Holder

Stainless steel ring provides solid support of embryo filter during embryo / oocyte collections and also allows the operator to maintain the filter at various heights.

- Stainless steel
- Attaches to ring stand rods up to 7/8" in diameter
- Fits both Em Con™ Filter (#04135) and Em Con™ IVF Oocyte Filters (#26505 & #26507)

Item	Product Description	UOM
25801	Em Con™ Embryo Filter Holder	Each



Acrodisc® Syringe Filter

The Acrodisc® Syringe Filter is used to filter serum and media in preparation for specific procedures. Fits luer lock and luer slip syringes.

- Individually packaged and sterile
- Single use item

Item	Product Description	UOM
04701	Acrodisc® Syringe Filter, 0.20 Micron	50/Box

ACRODISC is a registered trademark of Pall Corporation.



Albumin Solution

- Bovine Serum Albumin is of New Zealand origin, virus-screened and irradiated
- Water is highly purified with a low endotoxin specification
- Albumin functions as a surfactant, energy source and detoxifier for embryos during embryo transfer procedures
- Sterile-filtered

Item	Product Description	UOM
22502	Albumin Solution, 20% w/v, 20 ml - Non-Returnable, Refrigerate	5/Box



EMCARE™ Holding Solution



- For culturing embryos prior to transfer or freezing
- Contains New Zealand Bovine Serum Albumin
- Optimized nutrient composition improves embryo survival rate
- Available in three sizes

Item	Product Description	UOM
22506	EMCARE™ Holding Solution, 6 ml - Non-Returnable, Refrigerate	20/Box
22508	EMCARE™ Holding Solution, 20 ml - Non-Returnable, Refrigerate	5/Box
22510	EMCARE™ Holding Solution, 100 ml - Non-Returnable, Refrigerate	5/Box



EMCARE™ Ethylene Glycol 1.5M



- For freezing embryos for direct embryo transfer

Item	Product Description	UOM
22512	EMCARE™ Ethylene Glycol 1.5M, 6 ml - Non-Returnable, Refrigerate	20/Box
22514	EMCARE™ Ethylene Glycol 1.5M, 20 ml - Non-Returnable, Refrigerate	5/Box



EMCARE™ Glycerol 10% v/v



- Glycerol is a cryoprotectant that must be removed from the frozen embryo before it is transferred into a recipient

Item	Product Description	UOM
22520	EMCARE™ Glycerol 10% v/v, 6 ml - Non-Returnable, Refrigerate	20/Box



EMCARE™ Sucrose 34.2% w/v 1M



- For thawing embryos where Glycerol is the cryoprotectant

Item	Product Description	UOM
22525	EMCARE™ Sucrose 34.2% w/v 1M, 6 ml - Non-Returnable, Refrigerate	20/Box



EMCARE™ Thawing System



- For thawing embryos where Glycerol is the cryoprotectant
- Each kit contains 4 tubes, 6 ml each. Each kit contains one of each solution:
 - Solution #1: EMCARE™ 6% Glycerol & 10.3% w/v Sucrose
 - Solution #2: EMCARE™ 3% Glycerol & 10.3% w/v Sucrose
 - Solution #3: EMCARE™ 10.3% w/v Sucrose
 - Solution #4: EMCARE™ Holding Solution

Item	Product Description	UOM
22530	EMCARE™ Thawing System, 4 x 6 ml - Non-Returnable, Refrigerate	4 Kits/Box



EMCARE™ Complete Ultra Flushing Solution



- Contains New Zealand Bovine Serum Albumin providing surfactant and embryo protective properties with binding sites absorbing plasticizers, endotoxins and proteases
- MOPS buffered flushing solution
- Contains Kanamycin Sulfate
- Media is sterile-filtered
- Patented

Item	Product Description	UOM
22060	EMCARE™ Complete Ultra Flushing Solution, 1 Liter Bag - Non-Returnable	Each
22062	EMCARE™ Complete Ultra Flushing Solution, 2 Liter Bag - Non-Returnable	Each



EMCARE™ BioFree Flushing Solution



- Contains no items of biological origin
- Contains PVA as a substitute for Bovine Serum Albumin
- PVA exhibits the same surfactant activity without the risk of introducing adventitious viral agents or other biochemical contaminants
- Contains Kanamycin Sulfate
- MOPS buffered flushing solution
- Media is sterile-filtered

Item	Product Description	UOM
22065	EMCARE™ BioFree Flushing Solution, 1 Liter Bag - Non-Returnable	Each
22067	EMCARE™ BioFree Flushing Solution, 2 Liter Bag - Non-Returnable	Each



Bag & Bottle Warmers



- Flushing media stays warm in cold weather and cool in warmer temperatures
- Lightweight and durable
- Economical
- 1 and 2 liter bag warmers include carabiner
- 6 liter bag warmer includes carabiner

Item	Product Description	UOM
22808	Warmer for 500 cc Bottle	Each
22810	Warmer for 1 Liter Bottle	Each
22807	Warmer for 6 Liter Bag	Each
22805	Warmer for 2 Liter Bag	Each
22800	Warmer for 1 Liter Bag	Each



Filter Warmers



- Flushing media and embryos stay warm in cold weather and cool in warmer temperatures
- Protects embryos from harmful UV light
- Windows for monitoring fluid depth
- Item #25803 has open top, pulled cord bottom. All other warmers have zippered tops
- Lightweight and durable
- Economical

Item	Product Description	UOM
25803	Warmer for Em Con™ IVF Oocyte Filter or Em Con™ Filter	Each
25804	Warmer for MAI Low Volume E.T. Filter	Each
25805	Warmer for MAI High Volume E.T. Filter	Each
25810	Warmer for E.T. Filter	Each
25811	Warmer for Sure Flush™ E.T. Filter	Each



Embryo Transfer & Artificial Insemination Gun Warmer



- Keeps E.T. and A.I. gun warm in cold weather and cool in warmer temperatures
- Convenient shoulder strap
- Lightweight and durable
- Economical

Item	Product Description	UOM
26050	E.T. & A.I. Gun Warmer	Each



Square Gridded Dish

- Two-piece plastic square gridded search dish, 3"
- 100 mm x 100 mm x 15 mm
- Lid included
- Sterile
- Single use item

Item	Product Description	UOM
04041	Square Gridded Dish with Lid, 100 mm x 100 mm x 15 mm	10/Bag



Ova Transfer Dish

- Conical bowl-shaped polystyrene dish
- Used to search retained filtered flush media for embryos or oocytes
- Total volume capacity is 120 ml
- Gamma irradiated
- Single use item

Item	Product Description	UOM
04010	Ova Transfer Dish	12/Bag



Four Well Dish

- Two-piece polystyrene dish for holding, washing or freezing embryos
- Key-wayed lid has frosted area for plate coding
- Each well is numbered
- Ideal for four-step thawing of frozen embryos
- Large base prevents tipping
- Individually packaged and gamma irradiated
- Single use item

Item	Product Description	UOM
04056	Four Well Dish	10/Bag



Double Well Dish

- Two-piece polystyrene dish for holding, washing or freezing embryos
- Curved side of wells has a 20° radius
- Large base prevents tipping and key-wayed lid has frosted area for plate coding
- Each well is numbered
- Individually packaged and gamma irradiated
- Single use item

Item	Product Description	UOM
04055	Double Well Dish	20/Bag



Twelve Well Trypsin Dish

- Designed for in vivo and in vitro wash procedures
- Twelve - 2.5 ml volume wells
- Two - 1.2 ml volume rinse / discard wells
- Vented for gas exchange, open and closed positions
- Individually packaged and gamma irradiated
- Single use item

Item	Product Description	UOM
25150	Twelve Well Trypsin Dish, 96 mm x 96 mm	10/Bag



Petri Dish



- Two-piece polystyrene search dish
- 10 mm x 35 mm
- Gamma irradiated
- Single use item

Item	Product Description	UOM
04020	Petri Dish - 10 mm x 35 mm	20/Bag

ESP™ Tissue Culture Dishes



- Two-piece polystyrene culture dish
- Each well is numbered
- Individually packaged and gamma irradiated

ESP™ Tissue Culture Dish, Square Grid

- Single use item

Item	Product Description	UOM
04042	ESP™ Tissue Culture Dish, Square Grid	10/Bag

ESP™ Tissue Culture Dish, Six Well

- Six - 2.5 ml volume wells
- Single use item

Item	Product Description	UOM
04045	ESP™ Tissue Culture Dish, Six Well	10/Bag

ESP™ Tissue Culture Dish, Micro Six Well

- Six - 1 ml volume wells
- Single use item

Item	Product Description	UOM
04046	ESP™ Tissue Culture Dish, Micro Six Well	10/Bag

ESP™ Tissue Culture Dish, Four Well

- Single use item

Item	Product Description	UOM
04044	ESP™ Tissue Culture Dish, Four Well	10/Bag

ESP™ Tissue Culture Dish, Well in Well

- Single use item

Item	Product Description	UOM
04043	ESP™ Tissue Culture Dish, Well in Well	10/Bag

In Vitro Fertilization & Transfer Catheters



Designed to manipulate and/or move embryos in a dish or for dish to dish transfer.

IVF Catheters

- Inside diameter .025"
- Single use item

Item	Product Description	UOM
04183	IVF Catheter, Non-Sterile	Each
04185	IVF Catheter, Gamma Irradiated	Each

Tom Cat Catheter

- Inside diameter .018"
- Single use item

Item	Product Description	UOM
04186	Tom Cat Catheter, 3.5FR - 4-1/2", Sterile	Each

Embryo Transfer Catheter with Flex Adapter

- Fits luer slip tip syringe
- Inside diameter .022"
- Single use item

Item	Product Description	UOM
04187	Embryo Transfer Catheter with Flex Adapter, Gamma Irradiated	Each

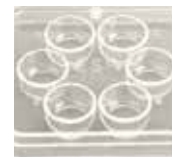

Straws

- Two straw sizes: 1/4 cc (inside diameter .060") and 1/2 cc (inside diameter .084")
- Uses a wick-and-powder method to seal contents
- Available gamma irradiated or non-sterile and in various package sizes
- All uncut straws are 5-1/4" long, all cut straws are 4-3/4" long
- Single use item



Item	Product Description	UOM
04156	Straw, Clear - 1/4 cc	100/Bag
04170	Straw, Clear - 1/4 cc Bulk	2,000/Bag
04158	Straw, Clear - 1/2 cc	100/Bag
04171	Straw, Clear - 1/2 cc Bulk	2,000/Bag
04174	Straw, Yellow - 1/4 cc Cut	100/Bag
04170Y	Straw, Yellow - 1/4 cc Bulk	2,000/Bag
04155	Straw, Yellow - 1/2 cc	100/Bag
04171Y	Straw, Yellow - 1/2 cc Bulk	2,000/Bag
04163	Straw, Clear, Cut - 1/4 cc, Gamma Irradiated	10 Bags of 5 Each
04164	Straw, Transparent Yellow, D.T. - 1/4 cc, Gamma Irradiated	10 Bags of 5 Each
04166	Straw, Clear - 1/4 cc, Gamma Irradiated	10 Bags of 5 Each
04168	Straw, Clear - 1/2 cc, Gamma Irradiated	10 Bags of 5 Each
26405	Straw, IMV, Red/White/Blue - 1/4 cc	5/Pack

Adapter Plugs

Two straw plug method, one straw contains the embryo and one straw identifies the contents.

- One end fits 1/4 cc straw, opposite end fits 1/2 cc straw
- Single use item

Item	Product Description	UOM
27825WH	Adapter Plug, White - 1/4 cc to 1/2 cc	100/Bag
27825YL	Adapter Plug, Yellow - 1/4 cc to 1/2 cc	100/Bag



Sealing Rods

One straw plug method that seals a 1/4 cc straw and allows for straw identification.

- Single use item

Item	Product Description	UOM
04154	Sealing Rod, White - 1/4 cc	100/Bag
04154Y	Sealing Rod, Yellow - 1/4 cc	100/Bag



Straw Adapters

Used to connect a 1/2 cc or 1/4 cc straw to a syringe.

- Single use item

Item	Product Description	UOM
27810	Straw Adapter - 1/4 cc	100/Bag
27812	Straw Adapter - 1/2 cc	100/Bag
27814	Universal Straw Adapter	10/Bag



27810



27814

Straw Cutter

Ideal for quickly and safely cutting the tips from sealed semen straws.

Item	Product Description	UOM
04160	Straw Cutter	Each



CITO Thaw Units

The CITO Thaw Unit is an electronic unit to heat and maintain accurate water temperature. This is a powered, glass-lined thermos with adjustable heat settings (factory preset to 96°F). The unit includes an accurate thaw monitor temperature indicator, fitted retrieval basket and power cord.

CITO Thaw Unit, 12-120-Volt AC

Item	Product Description	UOM
18483	CITO Thaw Unit, 12-120-Volt AC, Digital	Each

CITO Thaw Unit, 12-220-Volt AC

Item	Product Description	UOM
18485	CITO Thaw Unit, 12-220-Volt AC, Digital	Each

CITO Thaw Unit Replacement Part

Item	Product Description	UOM
18487	Cord - 12-Volt CITO Thaw Unit	Each



Plastic Straw Tweezers

Used for removing straws from racks, goblets or thaw units.

Item	Product Description	UOM
04161	Plastic Straw Tweezers	Each



Goblets

- Plastic cylindrical holders for storing straws containing semen or embryos inside a liquid nitrogen tank
- 10 mm size holds 12 - 1/4 cc or 5 - 1/2 cc straws
- 13 mm size holds 25 - 1/4 cc or 10 - 1/2 cc straws

Item	Product Description	UOM
04910	Goblet, Clear - 10 mm	100/Bag
04909	Goblet, Yellow - 10 mm	100/Bag
04911	Goblet, Clear - 13 mm	100/Bag
04912	Goblet, Yellow - 13 mm	100/Bag



Canes for Goblets

- Aluminum shafts hold two goblets in place inside a liquid nitrogen tank

Item	Product Description	UOM
04915	Cane for 10 mm Goblet	100/Bag
04916	Cane for 13 mm Goblet	100/Bag



Tabs for Canes

- Identification tabs to mark or code canes
- For 10 mm and 13 mm canes

Item	Product Description	UOM
27820WH	Tabs for Canes, White	100/Bag
27820YL	Tabs for Canes, Yellow	100/Bag
27820BL	Tabs for Canes, Blue	100/Bag
27820GN	Tabs for Canes, Green	100/Bag



Embryo Transfer Mini-Guns

- Smallest diameter at delivery tip is .060"
- Can be used with Item #04814 or #27530 Metallic Tip Sheath (See Page 29)
- Uses 1/4 cc straw
- No need to cut straws when using Deep Chamber Mini-Gun

Item	Product Description	UOM
04805	Embryo Transfer Mini-Gun 21", Deep Chamber, 1/4 cc for Uncut Straws	Each
04811	Embryo Transfer Mini-Gun 21", 1/4 cc for Cut or Uncut Straws	Each
04806	Replacement Donut for Mini-Gun	Each



Insemination Cuozzo Guns

- Straw is retained in the gun with a sheath that envelopes the outer diameter of the gun, securing the straw in place
- Stainless steel
- Use with standard 1/4 cc or 1/2 cc straws

Item	Product Description	UOM
26000	ESTROTECT™ Universal Gun, 18" for use with 1/4 cc or 1/2 cc Straws (for Split or Unsplit Sheaths of any brand, Blue Adapter #26300)	Each
04145	Cuozzo Gun, Standard 1/4 cc - 18" (use Universal Split Sheaths, Green Adapter & Donut or 17-1/2" STIP™ Tip Sheaths #27425)	Each
04146	Cuozzo Gun, Standard 1/2 cc - 18" (use Universal Split Sheaths, Green Adapter & Donut or 17-1/2" STIP™ Tip Sheaths #27425)	Each
04147	Cuozzo Gun, 1/2 cc Spiral - 18" (use Universal Unsplit Sheaths, Blue Adapter #26300)	Each
04148	Cuozzo Gun, 1/4 cc Spiral - 18" (use Universal Unsplit Sheaths, Blue Adapter #26300)	Each
04150	Cuozzo Gun, Standard 1/4 cc - 21" (use Split Sheath & Donut, 21" Side Metallic Sheath #04169 or 20-1/2" STIP™ Tip Sheath #27445)	Each
04152	Dual Mate™ Universal Gun, 21" for use with 1/4 cc or 1/2 cc Straws (use 20-1/2" STIP™ Tip Sheath #27445)	Each
27802	Replacement Donut for Cuozzo Gun	Each

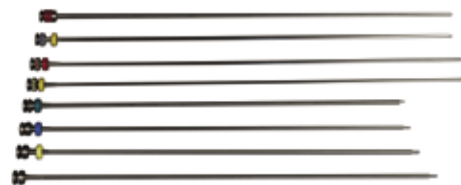

ESTROTECT™ Bovine Self-Locking Embryo Transfer Gun

Item	Product Description	UOM
26002	ESTROTECT™ Bovine Self-Locking Embryo Transfer Gun, 22" - for 1/4 cc Straws	Each



Chemise

- Plastic sheath that covers a Cuozzo or implant gun
- Helps prevent vaginal contamination
- Single use item

Item	Product Description	UOM
04810	Plastic Chemise - 18"	100/Box
04808	Plastic Chemise - 21"	80/Box



STIP™ Tip Sheaths

- Tapered tip split sheath uses 1/4 cc or 1/2 cc straws
- Ease in passing through cervix
- Tip allows for leakproof seating with straw
- Conveniently fits most guns
- Restricted diameter exit orifice projects semen in desired direction (inside diameter at tip .028")
- Tip reduces trailing of semen during withdrawal
- Dual function, use with fresh or frozen semen
- Lightweight and flexible
- Single use item



Item	Product Description	UOM
27425	STIP™ Tip Universal Split Sheath - 17-1/2"	25/Bag
27445	STIP™ Tip Universal Split Sheath - 20-1/2"	25/Bag
27500	STIP™ Tip Universal Split Sheath with Plastic Chemise - 20-1/2"	25/Bag

Standard, Universal & Metallic Tip Sheaths

- Outer plastic shell for a Cuozzo or implant gun retains a loaded straw within the gun
- End or side delivery for 1/4 cc or 1/2 cc straws
- Single use item



Item	Product Description	UOM
04151	Standard Split Sheath, 1/2 cc - 18"	5/Bag
04167	Standard Split Sheath, 1/2 cc without Adapter - 18"	50/Bag
04813	Standard Split Sheath, 1/2 cc without Adapter - 18" Individually Packaged	25/Bag
04165	Universal Split Sheath with Green Adapter - 18"	50/Bag
04159	Universal Unsplit Sheath with Blue Adapter - 18"	50/Bag
26300	Universal Unsplit Sheath with Blue Adapter - 18" (for use with item #26000 - ESTROTECT™ All-2-Mate™ Universal Gun)	50/Bag
04812	Universal Split Sheath with Green Adapter - 18" Individually Packaged	25/Bag
04817	Universal Unsplit Sheath with Blue Adapter - 18" Individually Packaged	25/Bag
04169	Metallic Tip Sheath, 1/4 cc Side Delivery, Clear - 21" (fits #04150)	5/Bag
04814	Metallic Tip Sheath, 1/4 cc Side Delivery, Blue - 21" (fits #04805 & #04811 Mini-Guns)	5/Bag
27530	Metallic Tip Sheath, 1/4 cc end or Side Delivery, Blue - 21" Individually Packaged, Sterile (fits #04805 & #04811 Mini-Guns)	5/Bag

Bovine Cervical Dilator

The Bovine Cervical Dilator is a stainless steel instrument used in embryo transfer to dilate the cervix in order to pass a catheter for embryo implantation collection.

- Tapered 22" length
- Stainless steel

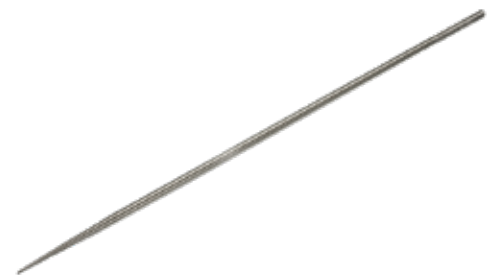

Item	Product Description	UOM
27100	Bovine Cervical Dilator	Each



Norm-Ject® Syringes

- All plastic syringe
- Non-spermicidal and non-embryocidal
- Eccentric (off centered) tip
- Individually packaged and sterile
- Single use item



Item	Product Description	UOM
04708	HSW Norm-Ject® Syringe, 1 cc, Sterile	100/Box
04710	HSW Norm-Ject® Syringe, 3 cc, Sterile	100/Box
04712	HSW Norm-Ject® Syringe, 5 cc, Sterile	100/Box
04714	HSW Norm-Ject® Syringe, 10 cc, Sterile	100/Box
04716	HSW Norm-Ject® Syringe, 20 cc, Sterile	100/Box
04719	HSW Norm-Ject® Syringe, 30 cc, Sterile	50/Box
04720	HSW Norm-Ject® Syringe, 60 cc, Sterile	30/Box

Pro-Ject™ 2-Piece Syringes - Luer Slip & Luer Lock Tips



A non-spermicidal, non-embryocidal syringe commonly used in artificial insemination (A.I.) and embryo transfer (E.T.) applications.

- Shorter stroke makes syringeability easier
- Larger finger grips
- Economical for one time disposable use
- Two-piece all plastic syringe
- Individually packaged and gamma irradiated
- Available in luer slip or luer lock tips
- Single use item



Item	Product Description	UOM
60020	Pro-Ject™ 2-Piece Syringe, Luer Slip Tip, 15 cc, Gamma Irradiated	100/Box
60040	Pro-Ject™ 2-Piece Syringe, Luer Slip Tip, 35 cc, Gamma Irradiated	50/Box
60060	Pro-Ject™ 2-Piece Syringe, Luer Slip Tip, 60 cc, Gamma Irradiated	30/Box
60080	Pro-Ject™ 2-Piece Syringe, Luer Slip Tip, 80 cc, Gamma Irradiated	25/Box
60021	Pro-Ject™ 2-Piece Syringe, Luer Lock Tip, 15 cc, Gamma Irradiated	100/Box
60041	Pro-Ject™ 2-Piece Syringe, Luer Lock Tip, 35 cc, Gamma Irradiated	50/Box
60061	Pro-Ject™ 2-Piece Syringe, Luer Lock Tip, 60 cc, Gamma Irradiated	30/Box
60081	Pro-Ject™ 2-Piece Syringe, Luer Lock Tip, 80 cc, Gamma Irradiated	25/Box



Syringe Caps



Syringe Caps attach to syringe tip to allow for safe transport and/or dispensing of medication.

Item	Product Description	UOM
02201	Syringe Cap, C14 Luer Lock	1,000/Bag
02202	Syringe Cap, C14 Luer Lock	500/Vial
02203	Syringe Cap, C14 Luer Lock	100/Vial
02204	Syringe Cap, C13 Luer Slip	1,000/Bag
02205	Syringe Cap, C13 Luer Slip	500/Vial
02206	Syringe Cap, C13 Luer Slip	100/Vial
60807	Cap for Oral Foley Tip Syringe	1,000/Bag
60808	Cap for Oral Foley Tip Syringe	500/Vial
60809	Cap for Oral Foley Tip Syringe	100/Vial



NORM-JECT is a registered trademark of Henke Saas, Wolf GmbH.



AccuBreed™ Cloud Electronic Heat Detection System

The new AccuBreed™ Cloud Electronic Heat Detection System features electronic components to capture every mounting event as it happens. Wireless, rechargeable transmitters are applied above the tail-head of a cow to digitally send a data stream with the date, time and duration of every mounting event in real time. All mounting data is collected, stored on a cloud-based server and made instantly available to the user through any computer, handheld device or smart phone.

The AccuBreed™ software applies specific criteria to captured mounting activity to minimize false positives. Upon logging in, users will see transmitter tracking numbers - which have been assigned to specific cows - separated into different lists based on mounting activity.

- Transmission distances have proven to be successful across a half-mile radius from the nearest base station or repeater
- Each transmitter has a tracking number assigned to a specific cow
- Average battery life of 3 months; rechargeable up to 500 times

The AccuBreed™ Electronic Heat Detection System is currently available to lease for 60 or 90 days. For more information, visit accubreedcloud.com or call us.



Item	Product Description	UOM
79051	AccuBreed™ 60 Day Lease System Kit	Each
79052	AccuBreed™ 90 Day Lease System Kit	Each
79067	AccuBreed™ Repeater with Solar Antenna	Each

How the AccuBreed™ System Communicates:

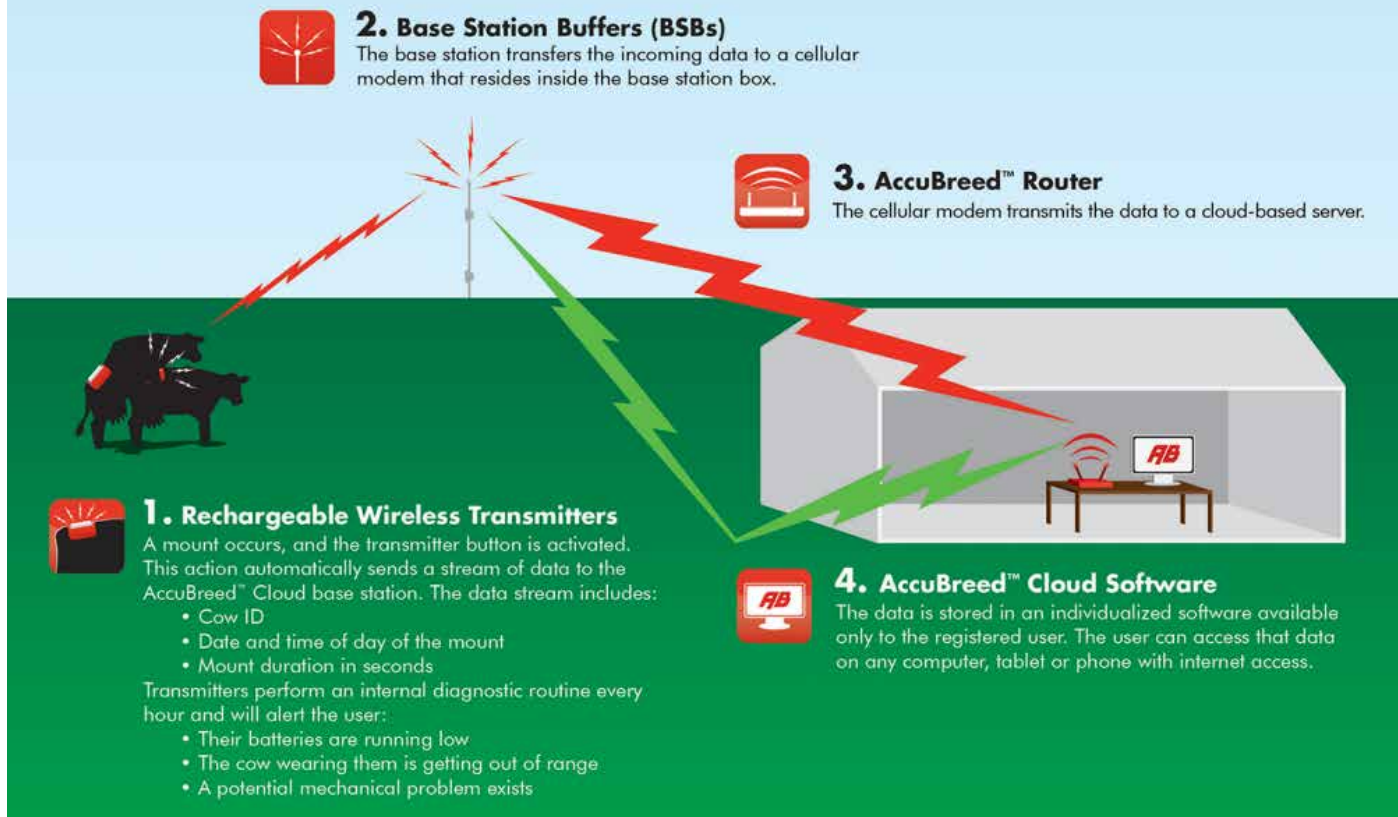

ESTROTECT™ Breeding Indicator with Breeding Bullseye™ PATENTED

The newly redesigned ESTROTECT™ Breeding Indicator features the patented precision-designed Breeding Bullseye™, which takes the guesswork out of your breeding program.

- **Understand results with pinpoint accuracy:** The ESTROTECT™ Breeding Indicator's silver and black ink rubs off as mounting activity occurs - a sign of cows entering estrus - indicating when an animal is ready to breed
- **Easy to apply:** Industry-leading self adhesive allows for easy application and reliable adhesion even in intense conditions
- **Increase confirmed pregnancy rates:** When activated, the precision-designed Breeding Bullseye indicated when cows are in optimal estrus to be bred. Third-party research has shown that when the Breeding Bullseye™ or an equivalent amount is rubbed off, confirmed pregnancy rates can increase by up to 3 times!
- **Applications include:**
 - ◆ Heat Detection
 - ◆ Confirming pregnancies
 - ◆ Artificial insemination - determine timing or standing heat
 - ◆ Determining cycling in cows and heifers prior to breeding
 - ◆ Natural service to determine cyclicity or pregnancy after breeding
 - ◆ Synchronization protocols - quality control and pinpointing breeding timing



Item	Product Description	UOM
78010	ESTROTECT™ Breeding Indicator with Breeding Bullseye™ - Red / Orange, 50 Count	Each
78019	ESTROTECT™ Breeding Indicator with Breeding Bullseye™ - Blue, 50 Count	Each
78016	ESTROTECT™ Breeding Indicator with Breeding Bullseye™ - Green, 50 Count	Each
78013	ESTROTECT™ Breeding Indicator with Breeding Bullseye™ - Fuchsia, 50 Count	Each
78022	ESTROTECT™ Breeding Indicator with Breeding Bullseye™ - Yellow, 50 Count	Each
78400	ESTROTECT™ Rubber Brush (Assorted Colors Available)	Each
78500	ESTROTECT™ Cleaning Cloth	Each



EstroTECT™ Breeding Indicators inform breeding decisions:

Less than 50%

Low Fertility

Wait to breed or use inexpensive semen

50% or more

High Fertility

Breed and use high-value semen, sexed semen or embryo transfer with more success



Glide AI™ Lubricant

A non-spermicidal, water soluble lubricating jelly specifically formulated for use with semen collection and reproductive procedures.

- Extra thick formulation for use with A/V liners
- Lubricant specifically formulated for semen collection
- Stays thick when warm to minimize semen and lubricant mixing together
- Non-spermicidal, non-embryocidal
- Ideal pH
- Used for collection in all species
- Water-soluble, colorless, odorless and stainless
- Irritation-free lubricant



Item	Product Description	UOM
17246	Glide AI™ Lubricating Jelly - 5 oz	Each
17247	Glide AI™ Lubricating Jelly - 16 oz	Each
17248	Glide AI™ Lubricating Jelly - Gallon	Each
04605	Pump for Gallon Jug	Each

Glide OB™ Lubricant

A non-spermicidal, water soluble lubricating jelly specifically formulated for use with obstetrical procedures, rectal exams and general use.

- Same product as the original Glide
- Slightly thinner product than Glide AI™
- Lubricant for obstetrical work, vaginal and rectal exams
- Non-spermicidal, non-embryocidal
- Ideal pH
- Water-soluble, colorless, odorless and stainless
- Irritation-free lubricant
- 5 oz tube features an easy to use flip top cap



Item	Product Description	UOM
17236	Glide OB™ Lubricating Jelly - 5 oz	Each
17237	Glide OB™ Lubricating Jelly - 16 oz	Each
17238	Glide OB™ Lubricating Jelly - Gallon	Each
04605	Pump for Gallon Jug	Each

GLIDE
Non-spermicidal
Lubricants

2 formulas
to meet your
needs



Shoulder-Length Plastic Sleeves - Non-Sterile & Gamma Irradiated

A complete selection of shoulder-length, disposable sleeves in assorted materials and thicknesses used for various large animal procedures. All gamma irradiated sleeves are individually packaged.

Ultra-Sens™ Sleeves

- 1 mil copolymer
- Length 36"
- Super sensitive feel
- Clear
- Non-sterile or gamma irradiated
- Single use item



Item	Product Description	UOM
19535	Ultra-Sens™ Sleeve - 1 mil	100/Box
19532	Ultra-Sens™ Sleeve - Individually Packaged & Gamma Irradiated	25/Bag

Yellow Sof™ Sleeves

- 1 mil copolymer
- Length 36"
- Super sensitive feel
- Non-sterile or gamma irradiated
- Single use item



Item	Product Description	UOM
32206	Yellow Sof™ Sleeve - 1 mil	50/Bag
19225	Yellow Sof™ Sleeve - Individually Packaged & Gamma Irradiated	25/Bag

Shyr™ Pro-Max Sleeves

- 1.25 mil polyethylene
- Length 35"
- For a large hand
- Non-sterile or gamma irradiated
- Single use item



Item	Product Description	UOM
19205	Shyr™ Pro-Max Sleeve, Grey - 1.25 mil	100/Bag
19222	Shyr™ Pro-Max Sleeve, Grey - Individually Packaged & Gamma Irradiated	25/Bag

Shyr™ Professional Sleeves

- 1.25 mil polyethylene
- Length 35"
- For a small hand
- Non-sterile or gamma irradiated
- Single use item



Item	Product Description	UOM
19200	Shyr™ Professional Sleeve, Green - 1.25 mil	100/Bag
19220	Shyr™ Professional Sleeve, Green - Individually Packaged & Gamma Irradiated	25/Bag

Poly Sens Sleeve, Blue

- 1.25 mil polyethylene
- Length 35"
- Non-sterile
- Single use item



Item	Product Description	UOM
32216	Poly Sens Sleeve, Blue - 1.25 mil	100/Bag



Disposable Sleeve

- 1.25 mil polyethylene
- Length 35"
- Non-sterile
- Single use item



Item	Product Description	UOM
32000	Disposable Sleeve, Clear - 1.25 mil	100/Box

Magnum Sleeve, Yellow

- 1.10 mil copolymer
- Length 39"
- Extremely sensitive feel
- Non-sterile
- Single use item



Item	Product Description	UOM
32210	Magnum Sleeve, Yellow - 1.10 mil	100/Bag

Magnum Sleeve, Brown

- 1.25 mil copolymer
- Length 39"
- High sensitivity and durability
- Non-sterile
- Single use item



Item	Product Description	UOM
32213	Magnum Sleeve, Brown - 1.25 mil	100/Bag

Gripper™ Shoulder-Length Plastic Sleeves - Non-Sterile & Gamma Irradiated



Disposable sleeve with a comfortable elastic band that retains the disposable sleeve onto the user's arm without the use of shrouds, hemostats or other devices. Simple yet effective for maintaining sleeve positioning.

- Ideal for prolonged use
- Available non-sterile, bulk or gamma irradiated, individually packaged

Gripper™ Ultra-Sens™ Sleeves

- 1 mil copolymer
- Length 36"
- Super sensitive feel
- Clear
- Non-sterile or gamma irradiated
- Single use item



Item	Product Description	UOM
32100	Gripper™ Ultra-Sens™ Sleeve - 1 mil	25/Bag
32110	Gripper™ Ultra-Sens™ Sleeve - Individually Packaged & Gamma Irradiated	25/Bag

Gripper™ Yellow Sof™ Sleeve

- 1 mil copolymer
- Length 36"
- Super sensitive feel
- Non-sterile
- Single use item



Item	Product Description	UOM
19300	Gripper™ Yellow Sof™ Sleeve - 1 mil	25/Bag



Latex OB Sleeves

Shoulder-length sleeves are made of latex material for arm and shoulder protection with a latex glove glued directly to the latex sleeve. A retention strap is affixed to the sleeve's shoulder to secure the sleeve onto the user's body.



Item	Product Description	UOM
32052	Latex OB Sleeve with Shoulder Strap - <i>Made to order</i>	Each
32054	Latex OB Sleeve & Glove with Shoulder Strap - Large - <i>Made to order</i>	Each
32055	Latex OB Sleeve & Glove with Shoulder Strap - X-Large - <i>Made to order</i>	Each

Ultra Sens™ Ultrasound Probe Cover



Item	Product Description	UOM
52600	Ultra Sens™ Ultrasound Probe Cover	25/Bag

ProBang™ Uterine Baton



Simplifies retracting and replacing an everted uterus in dairy and beef cows

The ProBang™ Uterine Baton is an essential instrument used to manually replace a prolapsed uterus post calving in dairy and beef cows. The unique design consists of two blunted bulbous ends and a plastic or stainless steel shaft, which acts as a third arm for the practitioner while replacing the everted uterus into the patient's body cavity.

- Bulb ends are uniquely designed for size and surface area when in contact with the uterus and user
- Either bulb may be used for the uterus while the other is placed against the abdomen of the user
- Baton may be used on a patient standing or in a down position
- Plastic bulbs are welded to shaft and are solid and impervious for ease in maintenance
- Two batons available:
 - ◆ Lightweight: Plastic shaft, .85 lbs
 - ◆ Heavyweight: Stainless steel shaft, 3.30 lbs



Item	Product Description	UOM
19002HW	ProBang™ Uterine Baton - Heavyweight	Each
19002LW	ProBang™ Uterine Baton - Lightweight	Each

Breech Retractor™



Stainless steel instrument used to aid in the reposition of a breech presentation of a fetus.

- Length 35-1/2"
- Blunted, rounded tip with a circular stop approximately four inches from the end is used by inserting the instrument tip into the fetus' rectum
- Circular stop on the instrument prevents over insertion and potential trauma to rectal walls. With physical force pushing the fetus anteriorly, the practitioner attains a physical advantage for repositioning the fetus for birth



Item	Product Description	UOM
17040	Breech Retractor™	Each



Ellis Uterine Detorsion Rod

Stainless steel instrument used to correct torsion or rotation of the uterus that may restrict the fetus from passing through the birth canal.

- Length 36-3/4"
- Rod shaft will not twist during use
- Single eyelet end for fetal feet manipulation
- Opposite end features groove plates for attachment of OB chains

Item	Product Description	UOM
17010	Ellis Uterine Detorsion Rod	Each



Fetal Repeller

Stainless steel instrument used to aid in the correction of wry-neck or head-back birth position of fetus.

- Length 35-1/2" with a handle at one end and U-shaped yoke at the other end
- U-shaped yoke is placed on the shoulder opposite of the neck and head direction
- With even force placed on the instrument, a practitioner has a physical advantage in repositioning the fetus' head for delivery

Item	Product Description	UOM
17042	Fetal Repeller	Each



Give cows calcium and vitamin D3 when they need it most.

Transition™ Calcium Bolus

For Post Calving
Metabolic Disorders
during freshening

- Fast dissolving
- Easy to administer
- Proven benefits



See Page 208 for More Information.



QUALITY - AFFORDABILITY - RELIABILITY

The MDS-Vet™ Transcervical Insemination Endoscope Kit is an affordable and effective solution for artificial insemination. The kit is adaptable to most existing light sources and video systems. The operating sheath will accommodate a 5FR catheter for semen delivery, as well as dual stopcocks for insufflation / irrigation and suction.

INCLUDES:

- Endoscope - three versions available
- 7 mm operating sheath with 2 mm operating channel (6FR) and dual stopcocks
- Lightpost adapters for ACMI-Storz®-Wolf
- Insufflation bulb
- Portable LED Light Source - Item #48335

See **page 124** for more information!



OPTIONAL:



48022 - Transcervical Insemination Rigid Endoscope Kit

- 30 cm length with 30 degree angle of view, 7 mm diameter sheath includes 2 mm operating channel and dual stopcocks

48025 - Transcervical Insemination Rigid Endoscope Kit

- 38 cm length with 30 degree angle of view, 7 mm diameter sheath includes 2 mm operating channel and dual stopcocks

48028 - Transcervical Insemination Rigid Endoscope Kit

- 43 cm length with 0 degree angle of view, 6 mm diameter sheath includes 2 mm operating channel and dual stopcocks

Item	Product Description	UOM
48022	Transcervical Insemination Endoscope Kit, 7 mm x 302 mm	Each
48025	Transcervical Insemination Endoscope Kit, 7 mm x 380 mm	Each
48028	Transcervical Insemination Endoscope Kit, 6 mm x 430 mm	Each
Optional Add-Ons		
48304	50-Watt LED Light Source	Each
48217	Fiber-Optic Light Guide	Each
48201	High-Resolution USB Endoscopy Camera	Each
48203	Focusing Endoscope Coupler	Each

Featuring two of the best brands in small animal dentistry; Ultima & Inovadent™.

Inovadent™ Dental Cart Systems

Inovadent™ Dental Carts have been carefully designed to fit any clinic's needs. All dental carts include the following features:

- Automatic handpiece selection
- Dual water delivery system, one for distilled water and one for Ultra Scale™ Solution
- Quick relieving valve for the dual water bottle system
- Auxiliary water port for an additional Piezoelectric Scaler
- Manual air purge feature for purging water from lines and handpieces
- Adjustable pressure regulator for water delivery system
- High Speed Handpiece water coolant On/Off switch
- Adjustable flow control valve
- Durable metal cabinet with powder coat finish
- Adjustable, easy to access handpiece pressure adjustments
- Aseptic tubing for ease of cleaning
- Power strip for extra equipment
- Easy access for maintenance
- Air Compressor
- Air Compressor is not enclosed and inner layout design is simple to access
- Rugged casters for easy rolling
- Aseptic handpiece holders for ease of cleaning
- 1,090 cubic inches of storage area with soft close lid for easy access
- Telescoping top from 27-1/2" to 38-1/2", 22" W, 27" D, ~135 lbs without water
- 3 year warranty on dental unit, 1 year warranty on handpieces and 6 month warranty on turbines

Each dental cart includes the Inovadent™ starter pack:

- 10 Disposable Oscillating Prophy Angles
- 10 Cups of Prophy Paste
- Magnetic Bur Block & Cover
- 12 Burs (2 of each)
 - ◆ # 54803 - Tapered Fissure #701L, FG, 19 mm
 - ◆ # 54821 - Round Tip Bur #2, FG, 19 mm
 - ◆ # 54777 - Round Tip #4, FG, 19 mm
 - ◆ # 54802 - Tapered Fissure Bur #701, FG, 19 mm
 - ◆ # 54826 - Round Tip Bur #6, FG, 19 mm
 - ◆ # 54813 - Tapered Fissure #702, FG, 19 mm
- KLAW™ Tips - sizes 1 & 4
- 1 bottle of Ultra Scale™ Dental Scaling Solution
- 1 Bio Lube® (cleaner and lubricant)
- Compressor Oil, 0.5 Liter



Inovadent™ Dental Cart

- Versa LED High Speed Handpiece with swivel
- Low Speed Handpiece
- Air / Water Syringe with autoclavable tip
- LED Piezoelectric Scaler
- Compressor, 4 gallon
- Other configurations available, please call for information

Item	Product Description	UOM
54022	Inovadent™ Dental Cart with LED High Speed Handpiece, LED Piezoelectric Scaler, Low Speed Handpiece & Air / Water Syringe	Each
54052	Inovadent™ Dental Cart with Non-LED High Speed Handpiece & Piezoelectric Scaler	Each
54018	Inovadent™ VersaCart™ with Compressor - 6 Gallon, Foot Pedal Operated Vacuum System, Quick Release Water Bottles & Suction	Each

BIO LUBE is a registered trademark of Warren L. Luckey.



Inovadent™ HS4W Dental Cart System

Inovadent™ HS4W Dental Carts have been carefully designed to fit any clinic's needs. All dental carts include the following features:

- Automatic handpiece selection
- Dual water delivery system, one for distilled water and one for Ultra Scale™ Solution
- Quick relieving valve for the dual water bottle system
- Auxiliary water port for an additional Piezoelectric Scaler
- Manual air purge feature for purging water from lines and handpieces
- Adjustable pressure regulator for water delivery system
- High Speed Handpiece water coolant On/Off switch
- Adjustable flow control valve
- Durable metal cabinet with powder coat finish
- Adjustable, easy to access handpiece pressure adjustments
- Aseptic tubing for ease of cleaning
- Power strip for extra equipment
- Easy access for maintenance
- DynAir® Oil-less Compressor
- Rugged casters for easy rolling
- Aseptic handpiece holders for ease of cleaning
- Telescoping top from 27-1/2" to 38-1/2", 22" W, 14" D
- 3 year warranty on dental unit, 1 year warranty on handpieces and 6 month warranty on turbines

Each dental cart includes:

- Versa LED High Speed Handpiece with swivel
- Low Speed Handpiece
- Air / Water Syringe with autoclavable tip
- LED Piezoelectric Scaler
- DynAir® Oil-less Compressor, 1 gallon
- 10 Disposable Oscillating Prophy Angles
- 10 cups of Prophy Paste
- Magnetic Bur Block & Cover
- 12 Burs (2 of each)
 - ◆ # 54803 - Tapered Fissure #701L, FG, 19 mm
 - ◆ # 54821 - Round Tip Bur #2, FG, 19 mm
 - ◆ # 54777 - Round Tip #4, FG, 19 mm
 - ◆ # 54802 - Tapered Fissure Bur #701, FG, 19 mm
 - ◆ # 54826 - Round Tip Bur #6, FG, 19 mm
 - ◆ # 54813 - Tapered Fissure #702, FG, 19 mm
- KLaw™ Tips - sizes 1 & 4
- 1 bottle of Ultra Scale™ Dental Scaling Solution
- 1 Bio Lube® (cleaner and lubricant)



Item	Product Description	UOM
54023	Inovadent™ HS4W Dental Cart with Oil-less Compressor, LED High Speed Handpiece, LED Piezoelectric Scaler, Low Speed Handpiece & Air / Water Syringe	Each

DYNAIR is a registered trademark of Jiangsu Dynamic Medical Technology Co., Ltd.



Ultima 500



The Ultima 500 Series is the original dental unit designed specifically for veterinarians. This system is housed by a custom shell that is durable, easy to maintain and clean. The unit is mobile and fits under most standard counter tops for easy storage after use.

System includes:

- Enclosed housing design
- Flat top can be used as additional working counter space for surgical instruments, tools, etc. (top edges are raised to keep round instruments from rolling off)
- Advanced E-Type low speed with 4:1 reduction nose cone for polishing (optional 1:1 blue nose cone available for exotics and rabbit dentistry)
- Satelec® Piezoelectric Scaler offers greater versatility from general cleanings to advanced dentistry (available with or without LED)
- Satelec® tips: #1 Universal tip for supragingival scaling; #2 Beavertail scaling tip for heavy calculus; #10P scaling tip for shallow pockets
- Versa LED High Speed Handpiece with swivel for greater visibility or Ultima standard push button high speed handpiece
- 3-way Air / Water Syringe
- Automatic handpiece selection
- Auxiliary water port for an additional Piezoelectric Scaler
- Dual water delivery system; one for distilled water and one for Ultra Scale™ Solution
- Water coolant On/Off switch
- Water adjustable flow control valve
- Adjustable, easy to access handpiece pressure adjustments
- Aseptic tubing for ease of cleaning
- Power strip for extra equipment
- Silent surge oil compressor for proven longevity

Ultima 500 models:

- Base model includes: three air lines and 3-way Air / Water Syringe
- NL (no lights) model includes: low speed polisher handpiece; push button high speed handpiece; built-in Satelec® Piezoelectric Scaler with 3 tips, 3-way Air / Water Syringe
- Complete model includes: low speed polisher handpiece; Versa LED high speed handpiece with swivel; built-in Satelec® LED Piezoelectric Scaler with 3 tips, 3-way Air / Water Syringe

Ultima 500 compressor options:

- Ultima 500 I: powered by a 1/2 horsepower single head pump compressor
- Ultima 500 II: powered by a 1 horsepower dual pump compressor and includes heavy duty venturi suction system
- All compressors include an auto vent feature for the air holding tank into a collection bottle every 30 minutes to extend the life of the compressor by preventing the holding tank from rusting and rupturing, as compared to standard dental units which must be vented manually
- 3 year warranty on dental unit, 3 year warranty on single and dual compressors, 1 year warranty on handpieces and 6 month warranty on turbines

Each dental cart includes the Ultima starter pack:

- 10 Disposable Oscillating Prophylaxis Angles
- 10 cups Prophylaxis Paste
- Magnetic Bur Block & Cover
- 12 Burs (2 of each):
 - ◆ 2 Tapered Fissure Bur #701, FG, 19 mm - Carbide bur
 - ◆ 2 Tapered Fissure Bur #701L, FG, 19 mm - Carbide bur
 - ◆ 2 Tapered Fissure Bur #702, FG, 19 mm - Carbide bur
 - ◆ 2 Round Tip Bur #2, FG, 19 mm - Carbide bur
 - ◆ 2 Round Tip Bur #4, FG, 19 mm - Carbide bur
 - ◆ 2 Round Tip Bur #6, FG, 19 mm - Carbide bur
- 1 bottle of Ultra Scale™ Dental Scaling Solution
- 1 Bio Lube™ (cleaner and lubricant)
- 1 Aspirator Tip (Ultima 500 II models only)



Item	Product Description	UOM
54041	Ultima 500 I (Base Model)	Each
54042	Ultima 500 I (NL) No Lights	Each
54043	Ultima 500 I (Complete)	Each
54045	Ultima 500 II (Base Model with Suction System)	Each
54046	Ultima 500 II (NL) No Lights	Each
54047	Ultima 500 II (Complete with Suction System)	Each

SATELEC is a registered trademark of Societe Pour La Conception Des Applications Des Techniques Electroniques S.A.T.E.L.E.C. Corporation.



Ultima 600 Ultima Dental Systems

The Ultima 600 Series is the newest dental unit designed specifically for veterinarians. This system is housed by a custom shell that is durable, easy to maintain and clean. The unit is mobile and fits under most standard counter tops for easy storage after use.

System includes:

- Enclosed housing design
- Flat top can be used as additional working counter space for surgical instruments, tools, etc. (top edges are raised to keep round instruments from rolling off)
- Advanced E-Type low speed with 4:1 reduction nose cone for polishing (optional 1:1 blue nose cone available for exotics and rabbit dentistry)
- Satelec® Piezoelectric Scaler offers greater versatility from general cleanings to advanced dentistry (available with or without LED)
- Satelec® tips: #1 Universal tip for supragingival scaling; #2 Beavertail scaling tip for heavy calculus; #10P scaling tip for shallow pockets
- Versa LED High Speed Handpiece with swivel for greater visibility or Ultima standard push button high speed handpiece
- 3-way Air / Water Syringe
- Automatic handpiece selection
- Auxiliary water port for an additional Piezoelectric Scaler
- Dual water delivery system, one for distilled water and one for Ultra Scale™ Solution
- Water coolant On/Off switch
- Water adjustable flow control valve
- Quick relieving valve for the dual water bottle system
- Adjustable, easy to access handpiece pressure adjustments
- Aseptic tubing for ease of cleaning
- 3" standard caster wheels
- Power strip for extra equipment
- Oil-less compressor
- Dimensions: 33" H x 21" D x 18" W



Ultima 600 models:

- Includes: three air lines and 3-way Air / Water Syringe (handpieces not included)
- NL (no lights) model includes: low speed polisher handpiece; push button high speed handpiece; built-in Satelec® Piezoelectric Scaler with 3 tips, 3-way Air / Water Syringe
- Complete model includes: low speed polisher handpiece; Versa LED high speed handpiece with swivel; built-in Satelec® LED Piezoelectric Scaler with 3 tips, 3-way Air / Water Syringe
- 3 year warranty on dental unit, 3 year warranty on single and dual compressors, 1 year warranty on handpieces and 6 month warranty on turbines

Each dental cart includes the Ultima starter pack:

- 10 Disposable Oscillating Prophy Angles
- 2 Tapered Fissure Bur #701, FG, 19 mm - Carbide bur
- 2 Tapered Fissure Bur #701L, FG, 19 mm - Carbide bur
- 2 Tapered Fissure Bur #702, FG, 19 mm - Carbide bur
- 2 Round Tip Bur #2, FG, 19 mm - Carbide bur
- 2 Round Tip Bur #4, FG, 19 mm - Carbide bur
- 2 Round Tip Bur #6, FG, 19 mm - Carbide bur
- 1 Aspirator Tip (Ultima 500 II models only)
- 1 Bio Lube™ (cleaner and lubricant)
- 10 cups Prophy Paste
- 1 bottle of Ultra Scale™ Dental Scaling Solution
- Magnetic Bur Block & Cover

Item	Product Description	UOM
54039	Ultima 600 NL with Oil-less Compressor	Each
54040	Ultima 600 Complete with Oil-less Compressor	Each



Inovadent™ Dental Work Stations

Inovadent™ Dental Work Stations have been carefully designed to accommodate any clinic's needs.

Each dental work station includes the following features:

- Automatic handpiece selection
- Auxiliary water port for an additional LED Piezoelectric Scaler
- Manual air purge feature for purging water from lines and handpieces
- High Speed Handpiece water coolant On/Off switch
- Adjustable flow control valve
- Durable metal cabinet with powder coat finish
- Adjustable, easy to access handpiece pressure adjustments
- Aseptic tubing for ease of cleaning
- Easy access for maintenance
- Aseptic handpiece holders for ease of cleaning



Each high speed unit includes the Inovadent™ starter pack:

- 10 Disposable Oscillating Prophy Angles
- 25 cups of Prophy Paste
- Magnetic Bur Block & Cover
- 12 Burs (2 of each)
 - # 54803 - Tapered Fissure Bur #701L, FG, 19 mm
 - # 54821 - Round Tip Bur #2, FG, 19 mm
 - # 54777 - Round Tip Bur #4, FG, 19 mm
 - # 54802 - Tapered Fissure Bur #701, FG, 19 mm
 - # 54826 - Round Tip Bur #6, FG, 19 mm
 - # 54813 - Tapered Fissure Bur #702, FG, 19 mm
- 1 Bio Lube™ (cleaner and lubricant)
- KLAW™ Tips - sizes 1 & 4
- 1 bottle of Ultra Scale™ Dental Scaling Solution

Item	Product Description	UOM
54028	Inovadent™ HS4 Counter Top Dental Work Station	Each
54230-1	Inovadent™ HS4W Counter Top Dental Work Station with Oil-less Compressor (Olympic Table)	Each
54230-2	Inovadent™ HS4W Arm Unit (Olympic Table)	Each

Inovadent™ HS4W Counter Top Dental Work Station

- Versa LED High Speed Handpiece with Swivel
- Low Speed Handpiece
- Air / Water Syringe with autoclavable tip
- LED Piezoelectric Scaler
- Dual water delivery system, one for distilled water and one for Ultra Scale™ Dental Scaling Solution
- Male and female quick disconnect (fittings are included)
- An air source is required to operate unit (compressed air or nitrogen)
- Water Bottles included

Item	Product Description	UOM
54230	Inovadent™ HS4W Counter Top Dental Work Station	Each



Inovadent™ Swing Arms

The HS4 may be mounted on a swing arm or pneumatic brake arm.

- Additional Swing Arms available for purchase

Item	Product Description	UOM
54210	Inovadent™ HS4 on 8" Swing Arm	Each
54212	Inovadent™ HS4 on 12" Swing Arm	Each
54214	Inovadent™ HS4 on 16" Swing Arm	Each
54216	Inovadent™ 16" Swing Arm - Arm Only	Each
54218	Inovadent™ 12" Swing Arm - Arm Only	Each
54220	Inovadent™ 8" Swing Arm - Arm Only	Each
54222	Inovadent™ 4" x 4" Swing Arm Wall Mount Bracket	Each



Water Delivery System

Item	Product Description	UOM
54240	Water Delivery System - 1.5 Liter Bottle	Each

Ultima 250

The Ultima 250 Series is designed with an all aluminum body that is durable and easy to maintain. With two versatile applications to choose from, arm mounted or table top, the 250 Series is ideal for practices with minimal workspace, mobile clinics or for use as a second dental unit to increase productivity. This sleek and compact unit provides superior performance during cleaning and extraction procedures.

- 3-way Air / Water Syringe is included with all Ultima Dental Systems
- Base models include: three air lines (handpieces not included)
- No Lights model includes: low speed polisher handpiece; push button high speed handpiece; built-in Satelec® Piezoelectric Scaler with 3 tips
- Complete model includes: low speed polisher handpiece; LED push button high speed handpiece; built-in Satelec® LED Piezoelectric Scaler with 3 tips
- An air source is required to operate unit (compressed air or nitrogen)
- Male and female quick disconnect (fittings are included)
- Nitrogen regulator sold separately
- Nitrogen E and H tanks must be obtained from a local supplier
- All arm units include 12" swing arm and wall mount
- Additional swing arms available
- Pole mount configurations available

Each dental cart includes the Ultima starter pack:

- 10 Disposable Oscillating Prophy Angles
- 2 Tapered Fissure Bur #701, FG, 19 mm - Carbide bur
- 2 Tapered Fissure Bur #701L, FG, 19 mm - Carbide bur
- 2 Tapered Fissure Bur #702, FG, 19 mm - Carbide bur
- 2 Round Tip Bur #2, FG, 19 mm - Carbide bur
- 2 Round Tip Bur #4, FG, 19 mm - Carbide bur
- 2 Round Tip Bur #6, FG, 19 mm - Carbide bur
- 1 Aspirator Tip (Ultima 500 II models only)
- 1 Bio Lube™ (cleaner and lubricant)
- 10 cups Prophy Paste
- 1 bottle of Ultra Scale™ Dental Scaling Solution
- Magnetic Bur Block & Cover

Item	Product Description	UOM
54031	Ultima 250 Table Top (Base Model)	Each
54032	Ultima 250 Table Top (NL) No Lights	Each
54033	Ultima 250 Table Top (Complete)	Each
54035	Ultima 250 Arm (Base Model)	Each
54036	Ultima 250 Arm (NL) No Lights	Each
54037	Ultima 250 Arm (Complete)	Each
54037-1	Ultima 250 Arm (Complete) with Oil-less Compressor (Olympic Table)	Each
54037-2	Ultima 250 Arm (Complete - Olympic Table)	Each



E-Series I - Table Top Electric Dental Unit Ultima Dental Systems

Ultima Dental Systems and Bien-Air® have cooperated in developing the first electric-driven dental machine specifically dedicated to small animal and equine dentistry. This breakthrough product provides the professional with a dedicated Ultima platform in conjunction with Bien-Air® Swiss electric handpiece technology. The compact system's electric handpiece delivers consistent torque differing significantly from air driven dental systems that can lose more than 50% of its speed when in contact with the surface to be cut.

- Consistent handpiece torque
- Complete system - new oil-free mini-compressor used to cool handpiece and pressurize the water system
- No plumbing required with two 1 liter water bottles, one for distilled water and one for Ultra Scale™ Dental Scaling Solution
- Water Coolant On/Off Switch
- Adjustable flow control valve
- Aseptic tubing for ease of cleaning
- Precision - dental cuts will be more precise as the cutting bur does not need to leave the cutting surface
- No handpiece vibration
- Satelec® Piezoelectric LED Scaler offers greater versatility from general cleanings to advanced dentistry
- 3-way Air / Water Syringe
- Precise speed - using either the power dial or the variable speed foot control
- Minimal maintenance - only need to oil and maintain the handpieces
- Small footprint - 27" H x 13" W x 13" D
- Weighs approximately 40 lbs

Each dental unit includes:

- 40,000 RPM electric handpiece
- 1:1 straight nose cone for speeds of 100 to 40,000 RPM
- 1:5 contra angle for speeds of 10,000 to 200,000 RPM
- Automatic Handpiece Selection
- Satelec® LED Piezoelectric Scaler
- Satelec® tips: #1 Universal tip for supragingival scaling; #2 Beavertail scaling tip for heavy calculus; #10P scaling tip for shallow pockets
- Speed control to dial in your preferred speed
- 1 bottle of Bien-Air® Spraynet™ Cleaning Spray
- 1 bottle of Bien-Air® Lubrifluid™ Lubricant
- 3 year warranty on dental unit, 1 year warranty on handpieces and 6 month warranty on turbines



Item	Product Description	UOM
54029	E-Series I - Table Top Electric Dental Unit	Each
54886	Spraynet™ Cleaning Spray, 500 ml	Each
54887	Lubrifluid™ Lubricant, 500 ml	Each

BIEN-AIR is a registered trademark of Bien-Air Dental SA.

Chlorhexidine-free

- *Inhibits bacteria that cause plaque*
- *Removes biofilm*
- *Increases dental machine longevity*

See Page 49 for More Information.

Ultra Scale™ Solution



Oil-less Compressor

- 3/4 horsepower compressor
- Displacement CFM 2.1
- Maximum pressure 120 psi
- Quiet air compressor (50 decibels)
- Tank: 1/2 gallon
- Pressure gauge and 1/4" quick disconnect outlet fitting
- Dimensions: 16.5" L x 7.5" W x 17.5" H
- Weight 53 lbs

Item	Product Description	UOM
54080	Oil-less Compressor - 1/2 Gallon, 115-Volt	Each



Oil Compressors

Ultima's state-of-the-art silent surge compressor is the quietest compressor on the market with superior longevity. The pumps are designed with Teflon®-coated pistons to prevent friction and cooling fins to reduce heat, keeping operating noise to a minimum. The silent surge series is available in 1/2 or 1 horsepower pumps. The silent surge compressor includes a 4 gallon air holding tank and an automatic holding tank drain system. The compressors are supported by Ultima's exclusive 5 year warranty.

Item	Product Description	UOM
54070	Ultima Single Head 1/2 Horsepower Compressor	Each
54071	Ultima Double Head 1 Horsepower Compressor	Each



Yearly Maintenance Kits

The yearly maintenance kits are used for changing the oil on Ultima compressors. All necessary filters are included. Compressor Oil also sold separately.

Item	Product Description	UOM
54079	Yearly Maintenance Kit without Pump	Each
54079P	Yearly Maintenance Kit with Pump	Each
UD0161	Compressor Oil - 24 oz	Each



JUN-AIR® Regulator Filter

Item	Product Description	UOM
54918	JUN-AIR® Regulator Filter - White Threaded	Each



JUN-AIR® Compressor Oil

Item	Product Description	UOM
54884	JUN-AIR® Compressor Oil - 0.5 Liter	Each



TEFLON is a registered trademark of The Chemours Company FC, LLC.
 JUN-AIR is a registered trademark of Gast Manufacturing, Inc. and Gast Group Ltd.



Intake Filter

Item	Product Description	UOM
54917	Intake Filter - Black Plastic	Each



Filter Element

Item	Product Description	UOM
54915	Filter Element - White	Each



Regulator Filter Replacement Kit

Item	Product Description	UOM
54919	Regulator Filter Replacement Kit	Each



Filter for Micro Mist Separator

Item	Product Description	UOM
54916	Filter for Micro Mist Separator - Black	Each



Regulator Filter

The compressor Regulator Filter prevents moisture produced by the air holding tank from reaching the regulated air line going to the dental unit. Includes O-Ring for the regulator filter housing.

Item	Product Description	UOM
UD0144	Regulator Filter with Plastic Housing O-Ring	Each



Intake Filter

The Intake Filter helps to protect the compressor by keeping dirt and debris from entering the compressor head.

Item	Product Description	UOM
UD0167	Intake Filter	Each



Coalescent Filter

The compressor Coalescent Filter prevents moisture produced by the air holding tank from reaching the regulated air line going to the dental unit. Includes O-Ring for the coalescent filter housing.

Item	Product Description	UOM
UD0140	Coalescent Filter with Plastic Housing O-Ring	Each



Compressor Pick Up / Collection Bottle

The Compressor Pick Up / Collection Bottle is used to collect the moisture produced by the air holding tank.

Item	Product Description	UOM
UD0191	Compressor Pick Up / Collection Bottle	Each



Water Bottles for Dental Cart

Item	Product Description	UOM
54925	Water Bottle for Dental Cart - 1 Liter	Each
54926	Water Bottle for Dental Cart - 1.5 Liter	Each
54928	Water Bottle with Hand Pump - 1 Gallon	Each



Quick Disconnect for Water Bottle

Item	Product Description	UOM
54860	Quick Disconnect for Water Bottle	Each



Gaskets for High / Low Speed Handpiece

Item	Product Description	UOM
54910	Gasket for High Speed Handpiece, 5-Hole Midwest - Autoclavable	Each
54911	Gasket for High / Low Speed Handpiece, 4-Hole Midwest - Autoclavable	Each



Gasket for Water Bottle

Item	Product Description	UOM
54912	Gasket for Water Bottle	Each



Disposable Oscillating Prophy Angles

- Oscillating 90 degrees
- Less heat
- Less mess than standard prophy angles
- Less gingival irritation
- Quieter than normal disposable prophy angles
- AAHA recommends using a new prophy tip or cup on every patient
- No wasted time in the autoclave

Item	Product Description	UOM
UD0311	Disposable Oscillating Prophy Angles, Soft Cup (100-Pack)	Each
54825	Disposable Oscillating Prophy Angles (10-Pack)	Each



Prophy Paste

- Fine grit, less likely to damage enamel

Item	Product Description	UOM
54828	Prophy Paste, Fine Grit (25-Pack)	Each
54829	Prophy Paste, Fine Grit (100-Pack)	Each



Ultra Scale™ Dental Scaling Solution

- Inhibits bacteria that cause plaque and cavities
- Contains a special lubricant for scaling and cutting
- Removes biofilm that builds up in the patient's mouth and equipment
- Disinfects teeth while masking mouth odor
- Chlorhexidine-free
- Mix with water and add directly to dental unit reservoir
- May be used in all types of dental units

Item	Product Description	UOM
54270	Ultra Scale™ Solution - 8.5 oz (250 ml)	12/Case



Bio Lube®

- Nano lubricant
- Improves sluggish handpieces
- Eliminates oil and spin stopping
- Increases turbine life
- Safe for high and low speed handpieces
- Will not void handpiece warranty
- Available individually or as a kit

Item	Product Description	UOM
54880	Bio Lube® Lubricant Kit - .25 oz Lubricant Pens (2) & 7 oz Cleaner	Each
54881	Bio Lube® Cleaner, 7 oz	Each
54882	Bio Lube® Lubricant Pen, .25 oz	Each
54883	Bio Lube® Lubricant Kit - 7 oz Lubricant & 7 oz Cleaner	Each



LED Pet Piezo™ Scaler

The LED Pet Piezo™ Scaler is a compact Piezoelectric Scaler. The unit features Auto Gain Control which stabilizes and adjusts power settings for optimal performance. The unit also has an LED handpiece and a large power dial surrounded by LED lit indicators for readability and easy access.

- Accommodates KLAW™ Tips
- Includes 4 scaler tips
- 1 year limited warranty

Item	Product Description	UOM
54246	LED Pet Piezo™ Scaler - 110-Volt	Each



Note:
Request a **KLAW™ tip chart**
(Item # 20-451-0004)
to assure quality
Piezo usage.

KLAW™ Tips

- Designed specifically for the veterinary market
- Zirconium Nitrate coating which helps to prevent scaler damage
- Ported tip to ensure water is being applied to area being cleaned

KLAW™ 1

A universal small instrument with a curved scaler tip designed for root surfaces. This curette design will eliminate hand scaling repetitive motion injuries and is useful for subgingival soft tissue curettage.

Item	Product Description	UOM
54830	KLAW™ 1 - Piezo Tip	Each



KLAW™ 2

A small instrument with a left 30-degree angle near the thin tip for ease of scaling difficult to reach areas. Designed for right mandibular buccal surfaces, left mandibular lingual surfaces, left maxillary buccal surfaces and right maxillary lingual surfaces.

Item	Product Description	UOM
54831	KLAW™ 2 - Piezo Tip	Each



KLAW™ 3

A version of the KLAW™ 2 with a right 30-degree angle near the tip for ease of scaling difficult to reach areas. Designed for left mandibular buccal surfaces, left mandibular lingual surfaces, left maxillary buccal surfaces and left maxillary lingual surfaces.

Item	Product Description	UOM
54832	KLAW™ 3 - Piezo Tip	Each



KLAW™ 4

A straight universal instrument for use on all tooth surfaces which is tapered with a tip angle of 110 degrees. Ideal for interdental areas with a sharpened blade useful for root scaling.

Item	Product Description	UOM
54833	KLAW™ 4 - Piezo Tip	Each



KLAW™ 6

A longer shaft version of the KLAW™ 4 with a wider diameter, heavy knurl and rounded tip, which creates a more aggressive action for removing heavy supragingival calculus.

Item	Product Description	UOM
54834	KLAW™ 6 - Piezo Tip	Each



KLAW™ Wrench

Designed to tighten / loosen the KLAW™ Tips on the Piezoelectric Scaler Handpiece.

Item	Product Description	UOM
54844	KLAW™ Wrench	Each



Satelec® LED Scaler Handpiece Ultima Dental Systems

The Satelec® LED Scaler Handpiece fits all Ultima Dental Systems' air driven dental delivery units with a built-in Satelec® LED Piezo Scaler. The handpiece has a bright LED light that illuminates the work area for easy use. The handpiece fits on units that are only equipped with Satelec® LED configurations. Includes a 1 year warranty.



Item	Product Description	UOM
54094	Satelec® LED Scaler Handpiece	Each
54092	Satelec® LED Handpiece Cord & Connector	Each

Satelec® Standard Piezo Scaler Handpiece Ultima Dental Systems

The Satelec® Standard Piezo Scaler Handpiece fits all Ultima Dental Systems' air driven dental delivery units with a built-in Standard Satelec® Piezo Scaler. The standard handpiece does not have a light. Includes a 1 year warranty.



Item	Product Description	UOM
54086	Satelec® Standard Piezo Scaler Handpiece	Each
54082	Satelec® Standard Handpiece Cord & Connector	Each

Piezoelectric Scaler Handpiece

- Autoclavable handpiece
- Powerful Scaler (23,000 - 32,000 Hz)

Item	Product Description	UOM
54250	Piezoelectric Scaler Handpiece	Each
54253	LED Piezoelectric Scaler Handpiece	Each



Scaler - Standard Piezo Tips

- Designed to clean the deep developmental grooves in canine and feline teeth and to remove calculus deposits, discoloration and eliminate bacterial plaque
- Reduces the need for manual instruments
- Tips are small and easy to thread onto Piezoelectric Scaler Handpiece
- Provides patient comfort

Scaler Tip 7

Item	Product Description	UOM
54850	Scaler Tip 7 - Pointed Universal Piezo Tip	Each



Scaler Tip 8

Item	Product Description	UOM
54851	Scaler Tip 8 - Rounded Piezo Tip	Each



Scaler Tip 9

Item	Product Description	UOM
54852	Scaler Tip 9 - Flat Chisel Head Piezo Tip	Each



Scaler Metric Tips for Piezo Technologies B1 or B3 Handpieces

Item	Product Description	UOM
54855	Scaler Tip Metric 20 - Similar Style to Tip 14	Each
54856	Scaler Tip Metric 27 - Similar Style to Tip 8	Each

#1-Universal Satelec® Tip Ultima Dental Systems

The #1-Universal Satelec® Tip is recommended for treating simple cases and gross supra-gingival scaling. Orientation tangential to the tooth's surface. Operates using a sweeping motion to "push" and "pull" calculus without damaging the enamel.

Item	Product Description	UOM
54121	#1-Universal Satelec® Tip	Each

#2-Heavy Calculus Satelec® Tip Ultima Dental Systems

The #2-Heavy Calculus Satelec® Tip is recommended for removing heavy calculus and for use on animals with a larger tooth surface.

Item	Product Description	UOM
54122	#2-Heavy Calculus Satelec® Tip	Each

10P-Perio Satelec® Tip Ultima Dental Systems

The 10P-Perio Satelec® Tip is designed for scaling shallow pockets (2 - 3 mm) and provides greater irrigation than other tips.

Item	Product Description	UOM
54130	10P-Perio Satelec® Tip	Each

Spotlight LED Standard Head High Speed Handpiece

- Built-in mini generator
- Direct LED illumination
- Titanium coated stainless steel

Item	Product Description	UOM
54158	Spotlight LED Standard Head High Speed Handpiece	Each
UD0328	Spotlight Replacement Standard Head Turbine	Each
UD0330	Spotlight Replacement Standard Head Button Head Cap	Each

Versa LED High Speed Handpiece

- Ceramic ball bearings
- Triple water spray
- LED - no light bulb
- Titanium surface
- Micro-generator produces power - no fiber-optic tubing
- Compatible with a wide variety of coupling systems and adapts to most existing units



Item	Product Description	UOM
54159	Versa LED High Speed Handpiece with Swivel	Each
54160	Versa LED High Speed Handpiece (no Coupler)	Each
54161	Versa Swivel Coupler for High Speed Handpiece	Each
54163	Versa LED Handpiece Replacement Turbine	Each
54164	Versa LED Handpiece Back Cap	Each
54165	Versa LED Handpiece Wrench	Each



High Speed Handpieces & Replacement Turbines



- Push button
- 400,000 RPM
- Autoclavable

Item	Product Description	UOM
54900	High Speed Handpiece with Fiber-Optics	Each
54901	High Speed Handpiece without Fiber-Optics	Each
54903	Replacement Turbine for High Speed Handpiece	Each



Fiber-Optic Light Bulb for High Speed Handpiece



Item	Product Description	UOM
54905	Fiber-Optic Light Bulb for High Speed Handpiece	Each



High Speed Push Button Back Cap Replacement



Item	Product Description	UOM
54907	High Speed Push Button Back Cap Replacement	Each



D*Tach™ Bur Extractor



PATENTED - Pending

- For use with handpieces #54900 and #54901

Item	Product Description	UOM
54930	D*Tach™ Bur Extractor	Each



Low Speed Handpieces



- Forward and reverse gears
- Head rotates 360° (minimizes hand fatigue)
- Durable
- Knurled for grip when changing heads, gears or polishing

Item	Product Description	UOM
54902	Low Speed Handpiece - 5,000 RPM	Each
54913	Low Speed Handpiece - 20,000 RPM	Each



Ultima E-Style Low Speed Polisher



Ultima Dental Systems

The Ultima E-Style Low Speed Polisher has a 20,000 RPM motor with a 4:1 reduction (5,000 RPM) nose cone for polishing. Includes a 1 year warranty.

Item	Product Description	UOM
54154	Ultima E-Style Low Speed Polisher	Each
54156	Motor Only	Each
UD0308	Blue Nose Cone 20,000 RPM	Each
UD0309	Green Nose Cone 5,000 RPM	Each



Syringe Replacement Tip

Item	Product Description	UOM
54920	Syringe Replacement Tip	Each



Syringe Button Repair

Item	Product Description	UOM
54921	Syringe Button Repair	Each



Syringe Tapered Barrel Kit

Item	Product Description	UOM
54922	Syringe Tapered Barrel Kit	Each



Tapered Fissure Burs

Item	Product Description	UOM
54802	Tapered Fissure Bur #701, FG, 19 mm - Carbide	5/Pack
54803	Tapered Fissure Bur #701L, FG, 19 mm - Carbide	5/Pack
54804	Tapered Fissure Bur #701L, HP, 45 mm - Carbide	5/Pack
54805	Tapered Fissure Bur #701L, Surgical, FG, 25 mm - Carbide	5/Pack
54806	Tapered Fissure Bur #701, Latch-Type, 19 mm - Carbide	5/Pack
54810	Tapered Fissure Bur #699, FG, 19 mm - Carbide	5/Pack
54811	Tapered Fissure Bur #700, FG, 19 mm - Carbide	5/Pack
54812	Tapered Fissure Bur #702L, Surgical, FG, 25 mm - Carbide	5/Pack
54813	Tapered Fissure Bur #702, FG, 19 mm - Carbide	5/Pack
54819	Rodent Bur #703, HP, 65 mm - Carbide	5/Pack



Round Tip Burs

Item	Product Description	UOM
54763	Round Tip Bur #8, HP, 45 mm - Carbide	5/Pack
54766	Round Tip Bur #6, FG Surgical, 25 mm - Carbide	5/Pack
54769	Round Tip Bur 1/4, FG Surgical, 25 mm - Carbide	5/Pack
54770	Round Tip Bur #4, FG, 19 mm - Diamond	5/Pack
54771	Round Tip Bur 1/2, FG, 19 mm - Carbide	5/Pack
54772	Round Tip Bur 1/4, FG, 19 mm - Carbide	5/Pack
54775	Round Tip Bur #8, FG, 19 mm - Diamond	6/Pack
54776	Round Tip Bur #2, Latch-Type, 19 mm - Carbide	5/Pack
54777	Round Tip Bur #4, FG, 19 mm - Carbide	5/Pack
54778	Round Tip Bur #4, FG Surgical, 25 mm - Carbide	5/Pack
54779	Round Tip Bur #1, FG, 19 mm - Carbide	5/Pack
54821	Round Tip Bur #2, FG, 19 mm - Carbide	5/Pack
54822	Round Tip Bur #2, Surgical, 25 mm - Carbide	5/Pack
54826	Round Tip Bur #6, FG, 19 mm - Carbide	5/Pack



Acrylic Burs

Item	Product Description	UOM
54773	Acrylic Bur, 2.3 mm Diameter	Each
54774	Acrylic Bur, 6 mm Diameter	Each



Pear-Shape Burs

Item	Product Description	UOM
54820	Pear-Shape Bur #330, FG, 19 mm - Carbide	5/Pack
54824	Pear-Shape Bur #331, FG, 19 mm - Carbide	5/Pack
54823	Pear-Shape Bur #332L, FG, 19 mm - Carbide	5/Pack



Diamond Discs

Item	Product Description	UOM
54780	Diamond Disc, 18 mm	Each
54781	Diamond Disc, 20 mm	Each
54782	Diamond Disc, 22 mm	Each



Magnetic Bur Block & Cover

- Non-slip feet for safety, stability and convenience
- Durable, self-lubricating plastic
- Fits friction grip burs
- Holds 14 burs
- Autoclavable
- 1" cover (non-autoclavable)

Item	Product Description	UOM
54800	Magnetic Bur Block & Cover	Each

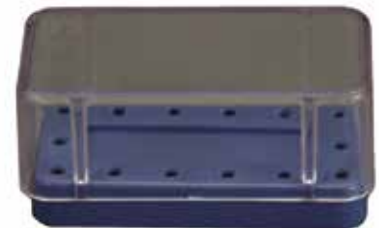

Dentanomic Modular Dental Instruments

Dentanomic Modular Dental Instruments were created for safer, faster and easier dental surgery. The innovative modular design allows for easy replacement of blades or other parts of the instruments without having to replace a whole damaged instrument as with other systems. Dentanomic blades are made from top quality hardened tempered stainless steel, which increases blade effectiveness and makes surgery easier. The blades support two common surgical techniques, elevation and luxation. The instruments also promote a safer 'palm grip' technique which helps prevent dangerous slips and reduces hand fatigue and repetitive injury to the dental surgeon. The instrument fits in the palm of the hand with blades that are easily interchangeable and replaceable. One handle accommodates all blade sizes and handles are designed for small or large hands.

Dentanomic Modular Dental Instruments - Full Set

Item	Product Description	UOM
54547	Dentanomic Full Set Replacement Blades	Each



Dentanomic Dental Kits

Three options to get you started using Dentanomic Instruments in your practice.

Gold Kit includes:

- 5 Ergonomic Handles - Small or Large, 1 of each color
- 4 Elevation Blades
- 5 Luxation Blades
- 1 Autoclave Tray for Handles
- 1 Autoclave Tray for Luxation and Elevation Blades
- 1 Blade Honing Pack



Silver Kit includes:

- 3 Ergonomic Handles - Small or Large, 1 Blue, 1 Green, 1 Pink
- 4 Elevation Blades
- 5 Luxation Blades
- 1 Autoclave Tray for Luxation and Elevation Blades
- 1 Blade Honing Pack



Bronze Kit includes:

- 2 Ergonomic Handles - Small or Large, 1 Gold, 1 Purple
- 4 Elevation Blades
- 5 Luxation Blades
- 1 Autoclave Tray for Luxation and Elevation Blades



Item	Product Description	UOM
54595-SM	Gold Dentanomic Dental Kit - Small Handles	Each
54595-LG	Gold Dentanomic Dental Kit - Large Handles	Each
54596-SM	Silver Dentanomic Dental Kit - Small Handles	Each
54596-LG	Silver Dentanomic Dental Kit - Large Handles	Each
54597-SM	Bronze Dentanomic Dental Kit - Small Handles	Each
54597-LG	Bronze Dentanomic Dental Kit - Large Handles	Each



Dentanomic Elevation Blades

Item	Product Description	UOM
54543-2	Dentanomic Elevation Blade, 2 mm	Each
54543-3	Dentanomic Elevation Blade, 3 mm	Each
54543-4	Dentanomic Elevation Blade, 4 mm	Each
54543-5	Dentanomic Elevation Blade, 5 mm	Each



Dentanomic Luxation Blades

Item	Product Description	UOM
54545-1.5	Dentanomic Luxation Blade, 1.5 mm	Each
54545-2	Dentanomic Luxation Blade, 2 mm	Each
54545-3	Dentanomic Luxation Blade, 3 mm	Each
54545-4	Dentanomic Luxation Blade, 4 mm	Each
54545-5	Dentanomic Luxation Blade, 5 mm	Each



Dentanomic Luxation Blades - Equine

- Length 3"

Item	Product Description	UOM
53460-4	Dentanomic Equine Luxation Blade, 4 mm	Each
53460-5	Dentanomic Equine Luxation Blade, 5 mm	Each



Dentanomic Equine Contra Angle Blades

- Length 3"

Item	Product Description	UOM
53461-4	Dentanomic Equine Contra Angle Blade, 4 mm	Each
53461-5	Dentanomic Equine Contra Angle Blade, 5 mm	Each



Dentanomic Ergonomic Handles

Item	Product Description	UOM
Dentanomic Ergonomic Handles - Small (for glove size < 7.5)		
54542-SMGN	Dentanomic Small Ergonomic Handle - Green	Each
54542-SMPK	Dentanomic Small Ergonomic Handle - Pink	Each
54542-SMBL	Dentanomic Small Ergonomic Handle - Blue	Each
54542-SMGD	Dentanomic Small Ergonomic Handle - Gold	Each
54542-SMPR	Dentanomic Small Ergonomic Handle - Purple	Each
Dentanomic Ergonomic Handles - Large (for glove size > 7.5)		
54542-LGGN	Dentanomic Large Ergonomic Handle - Green	Each
54542-LGPK	Dentanomic Large Ergonomic Handle - Pink	Each
54542-LGBL	Dentanomic Large Ergonomic Handle - Blue	Each
54542-LGGD	Dentanomic Large Ergonomic Handle - Gold	Each
54542-LGPR	Dentanomic Large Ergonomic Handle - Purple	Each



Dentanomic Accessories

Item	Product Description	UOM
54544	Dentanomic Autoclave Tray for Luxation & Elevation Blades	Each
54575	Dentanomic Autoclave Tray for Handles	Each
54592	Dentanomic Blade Honing Pack	Each

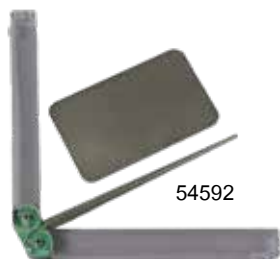

VIEW VIDEOS ON DENTANOMIC INFORMATION:

To view, scan QR code with camera on cell phone, or go to YouTube.com and search MAI Animal Health.

INTRO

HONING

CLEANING

ExtractEZE™ Root Tip Remover **PATENTED**

A finger tip grip instrument used to extract broken, severely worn or decayed root tips from patients. It allows the practitioner to quickly secure and remove the root tip from the tooth socket while minimizing damage to the surrounding tissue.

- Does NOT attach to high or low speed handpieces
- Working end has a sharp surgical screw tip, with each thread designed to be an anchoring, cutting edge which secures into the root's dentin once seated
- Surgical cutting edges are designed to allow the Root Tip Remover (RTR) to "self-seat" into the root canal walls
- Designed to find and access the root canal within the limited space and visibility of the patient's mouth
- Cutting edge angle of the RTR easily anchors into a larger root tip canal, providing leverage to sever the periodontal ligament in most cases
- Due to the various degrees of ligament attachment to the root, luxation may be needed. Inserting the RTR prior to luxation is recommended

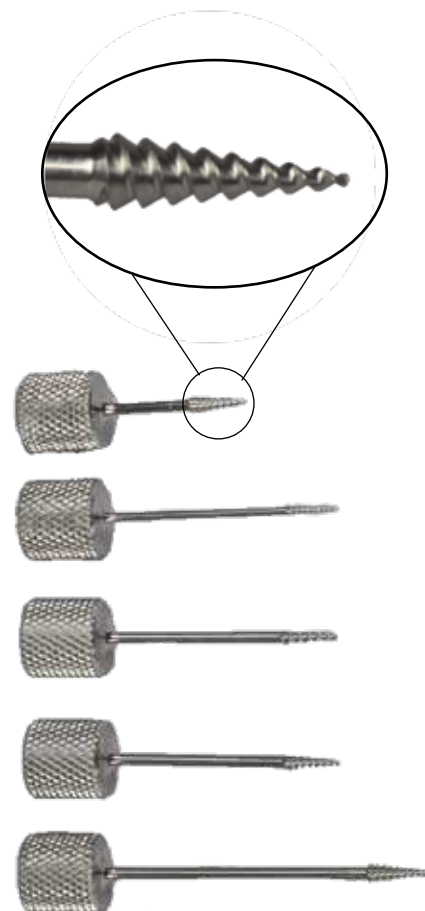

Item	Product Description	UOM
54560	ExtractEZE™ RTR - 12 mm Working Length - J50	Each
54561	ExtractEZE™ RTR - 19 mm Working Length - J55	Each
54563	ExtractEZE™ RTR - 26 mm Working Length - L60	Each
54564	ExtractEZE™ RTR - 19 mm Working Length, Feline - J55F	Each
54565	ExtractEZE™ RTR - 19 mm Working Length - K55	Each
54562	ExtractEZE™ RTR Set - J55 & J55F	Set of 2
54566	ExtractEZE™ RTR Set - J50, J55, K55, L60 & J55F	Set of 5
54567	ExtractEZE™ RTR Set - J55, K55 & L60	Set of 3
54568	ExtractEZE™ RTR Set - J50 & J55	Set of 2



Elevators

Elevators are available in two different sizes. Traditional sized handles are readily available. The new compact Elevator has been specially designed with a smaller handle and a shorter tip providing extra control for veterinarians with smaller hands.



Standard



Compact

Elevator #34

Item	Product Description	UOM
54520	Elevator #34	Each
54520C	Elevator #34 - Compact	Each



Elevator #34S

Item	Product Description	UOM
54521	Elevator #34S	Each
54521C	Elevator #34S - Compact	Each



Elevator #46

Item	Product Description	UOM
54522	Elevator #46	Each
54522C	Elevator #46 - Compact	Each



Elevator #301

Item	Product Description	UOM
54523	Elevator #301	Each
54523C	Elevator #301 - Compact	Each



Feline Elevator #301F

Item	Product Description	UOM
54531	Feline Elevator #301F	Each
54531C	Feline Elevator #301F - Compact	Each



Feline Notched Elevators

Item	Product Description	UOM
54533	Feline Notched Elevator - Curved Lower	Each
54534	Feline Notched Elevator - Curved Upper	Each



Winged Elevators

Item	Product Description	UOM
54525	Winged Elevator, 1 mm	Each
54525C	Winged Elevator, 1 mm - Compact	Each
54526	Winged Elevator, 2 mm	Each
54526C	Winged Elevator, 2 mm - Compact	Each
54527	Winged Elevator, 3 mm	Each
54527C	Winged Elevator, 3 mm - Compact	Each
54528	Winged Elevator, 4 mm	Each
54528C	Winged Elevator, 4 mm - Compact	Each
54529	Winged Elevator, 6 mm	Each
54529C	Winged Elevator, 6 mm - Compact	Each
54530	Winged Elevator, 8 mm	Each
54530C	Winged Elevator, 8 mm - Compact	Each



Freer Elevator #3

Item	Product Description	UOM
54535	Freer Elevator #3	Each



Molt Periosteal Elevator #9

Item	Product Description	UOM
54536	Molt Periosteal Elevator #9	Each



West Periosteal Elevator #2

Item	Product Description	UOM
54537	West Periosteal Elevator #2	Each



Vet Periosteotome

Item	Product Description	UOM
54519	Vet Periosteotome	Each



Winged Elevator Set - Sizes 1-4

Item	Product Description	UOM
54540	Winged Elevator Set - Sizes 1-4	Each
54540C	Winged Elevator Set - Sizes 1-4 - Compact	Each



Winged Elevator Set - Sizes 1-4, 6 & 8

Item	Product Description	UOM
54541	Winged Elevator Set - Sizes 1-4, 6 & 8	Each
54541C	Winged Elevator Set - Sizes 1-4, 6 & 8 - Compact	Each



Heidbrink Root Tip Pick - Straight



Item	Product Description	UOM
54570	Heidbrink Root Tip Pick - Straight	Each



Heidbrink Root Tip Pick - Left Angle



Item	Product Description	UOM
54571	Heidbrink Root Tip Pick - Left Angle	Each



Heidbrink Root Tip Pick - Right Angle



Item	Product Description	UOM
54572	Heidbrink Root Tip Pick - Right Angle	Each



Dental Mouth Mirror #5



Item	Product Description	UOM
54590	Dental Mouth Mirror #5	Each



Rodent Tongue Spatula



Item	Product Description	UOM
54490	Rodent Tongue Spatula	Each



Mouth Gag for Rodents



Item	Product Description	UOM
54491	Mouth Gag for Rodents	Each



Cheek Dilator - Small



Item	Product Description	UOM
54480	Cheek Dilator - Small	Each



Cheek Dilator - Large



Item	Product Description	UOM
54481	Cheek Dilator - Large	Each



Molar Cutters



Item	Product Description	UOM
54485	Molar Cutters	Each





Crossley Incisor Luxator

Item	Product Description	UOM
54488	Crossley Incisor Luxator	Each



Molar Rasp - Fine

Item	Product Description	UOM
54486	Molar Rasp - Fine	Each



Molar Rasp - Rabbit

Item	Product Description	UOM
54487	Molar Rasp - Rabbit	Each



Barnhart Curette 5/6

Item	Product Description	UOM
54550	Barnhart Curette 5/6	Each



McCalls Curette 17/18

Item	Product Description	UOM
54551	McCalls Curette 17/18	Each



Columbia Curette 13/14

Item	Product Description	UOM
54552	Columbia Curette 13/14	Each



Gracey Curette 13/14

Item	Product Description	UOM
54557	Gracey Curette 13/14	Each



Explorer Probe 1/23

Item	Product Description	UOM
54553	Explorer Probe 1/23	Each



Perio Probe 3-6-9-12

Item	Product Description	UOM
54554	Perio Probe 3-6-9-12	Each



Sickle Scaler

Item	Product Description	UOM
54555	Sickle Scaler	Each





USI Basic Dental Pack - 7 Instruments

- Winged Elevator - 2 mm
- Winged Elevator - 4 mm
- Double Ended Tartar Scraper #12
- Jacquette Scaler #2/3
- Double Ended Towner Scaler #15/30
- Explorer / Measuring Probe #23/CP11 Color Coded
- Small Breed Extractor

Item	Product Description	UOM
54300	USI Basic Dental Pack (7 Instruments)	Each



USI General Purpose Dental Pack - 14 Instruments



- Winged Elevator - 1 mm
- Winged Elevator - 2 mm
- Winged Elevator - 3 mm
- Winged Elevator - 4 mm
- Winged Elevator - 6 mm
- Straight Root Tip Pick #78
- Tartar Removing Forceps, 4.5"
- Small Breed Extractor
- Minnesota Retractor
- Gracey Curette #13/14
- Jacquette Scaler #2/3
- Towner Scaler #15/30
- Explorer / Measuring Probe #23/CP11 Color Coded
- Double Ended Molt Periosteal Elevator #2/4

Item	Product Description	UOM
54310	USI General Purpose Dental Pack (14 Instruments)	Each



USI Essential Oral Surgery Pack - 11 Instruments



- Winged Elevator - 2 mm
- Winged Elevator - 3 mm
- Winged Elevator - 4 mm
- Scalpel Handle #3
- SuperCut Iris Scissors - Straight
- SuperCut Iris Scissors - Curved
- German Mayo Hegar Needle Holder Tungsten Carbide, 5.5"
- Double Ended Molt Periosteal Elevator #2/4
- Luxating Elevator - 3 mm Curved
- Luxating Elevator - 5 mm Curved
- Small Breed Extractor

Item	Product Description	UOM
54305	USI Essential Oral Surgery Pack (11 Instruments)	Each



USI Oral Surgery Pack - 16 Instruments



- Winged Elevator - 2 mm
- Winged Elevator - 3 mm
- Winged Elevator - 4 mm
- Scalpel Handle #3
- SuperCut Iris Scissors - Straight
- SuperCut Iris Scissors - Curved
- German Mayo Hegar Needle Holder Tungsten Carbide, 5.5"
- Double Ended Molt Periosteal Elevator #2/4
- Luxating Elevator - 3 mm Curved
- Luxating Elevator - 5 mm Curved
- Small Breed Extractor
- Adson Brown Forceps
- (2) Heidbrink Root Tip Elevators
- Explorer / Measuring Probe #23/CP11 Color Coded
- Senn Retractor

Item	Product Description	UOM
54315	USI Oral Surgery Pack (16 Instruments)	Each



Mixing Spatula

Item	Product Description	UOM
54609	Mixing Spatula	100/Pack



Micro Applicator Brush

Item	Product Description	UOM
54610	Micro Applicator Brush - Super Fine	100/Pack



Acrylic Temporary Crown Material

Item	Product Description	UOM
54607	Acrylic Temporary Crown Material, 50 ml Cartridge with 10 Mixing Tips	Each



SA
SMALL
ANIMAL

Size 2 Sensor Sleeve

Item	Product Description	UOM
52770	Size 2 Sensor Sleeve	500/Box



X-ray Shield

- Constructed of durable aluminum
- Lead lined
- Portable

Item	Product Description	UOM
52800	X-ray Shield with Handle - 20" x 16" x 1"	Each



Skull Models with Removable Teeth & Gingiva

Item	Product Description	UOM
54950	Canine Skull Model with Removable Teeth & Gingiva	Each
54951	Replacement Teeth - Canine Skull	Set
54948	Feline Skull Model with Removable Teeth & Gingiva	Each
54949	Replacement Teeth - Feline Skull	Set



OnPointe™ Laser X-ray Guide 

Used in digital imaging procedures, OnPointe™ assists users taking a digital image or standard X-ray by targeting a specific site to be imaged.

- Fits most dental X-ray units
- Easy operation
- Affixes securely with Velcro®
- Includes the OnPointe™ Laser X-ray Guide User Manual

Item	Product Description	UOM
52205	OnPointe™ Laser X-ray Guide for 2.5" X-ray Tube Head	Each
52207	OnPointe™ Laser X-ray Guide for 2.625" X-ray Tube Head	Each
52209	OnPointe™ Laser X-ray Guide for 2.75" X-ray Tube Head	Each
52211	OnPointe™ Laser X-ray Guide for 3" X-ray Tube Head	Each



OnPointe™ Laser X-ray Guide User Manual 

Illustrates proper techniques for achieving high quality X-rays on all teeth for both canine and feline. Includes images of animal positioning, X-ray images and text explaining proper positioning.

Item	Product Description	UOM
05-450-0031	OnPointe™ Laser X-ray Guide User Manual	Each

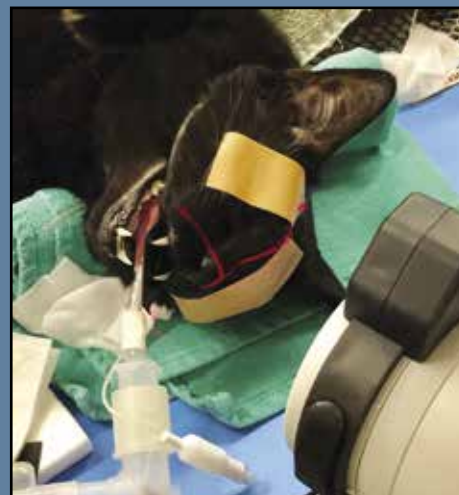
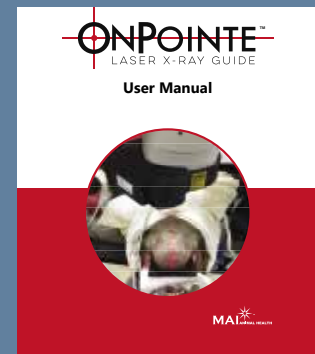

Dentanomic blades are made with a high-quality super slim edge, allowing surgeons to operate directly on the periodontal ligament, which makes dental extractions easier, safer and faster. Kit maintenance is simple with easily replaceable blades.

SIZING TIP:

Veterinarians with a glove sizes of 7.5 and under should use Small Dentanomic Ergonomic Handles.

Veterinarians with a glove size of 8 and above should use the Large Dentanomic Ergonomic Handles.



GOLD KIT



Gold Kit includes:

- 5 Ergonomic Handles - Small or Large
- 4 Elevation Blades
- 5 Luxation Blades
- 1 Autoclave Tray for Handles
- 1 Autoclave Tray for Luxation & Elevation Blades
- 1 Blade Honing Pack

Five handles means that you'll rarely have to change blades during surgery. Full range of blades allows adjustment to a variety of different sizes and types of teeth. The autoclave trays for blades and handles make cleaning, storing and organizing easy.

Item	Product Description	UOM
54595-SM	Gold Dentanomic Dental Package - Small Handles	Each
54595-LG	Gold Dentanomic Dental Package - Large Handles	Each

SILVER KIT



Silver Kit includes:

- 3 Ergonomic Handles - Small or Large
- 4 Elevation Blades
- 5 Luxation Blades
- 1 Autoclave Tray for Luxation & Elevation Blades
- 1 Blade Honing Pack

Three handles allows for completion of procedures with only occasional blade changes. Included honing kit allows for easy honing and maintenance of blade edges.

Item	Product Description	UOM
54596-SM	Silver Dentanomic Dental Package - Small Handles	Each
54596-LG	Silver Dentanomic Dental Package - Large Handles	Each

BRONZE KIT



Bronze Kit includes:

- 2 Ergonomic Handles - Small or Large
- 4 Elevation Blades
- 5 Luxation Blades
- 1 Autoclave Tray for Luxation & Elevation Blades

Includes everything needed to get started. Full range of blades allows adjustment to a variety of different sizes and types of teeth. The autoclave trays for blades and handles make cleaning, storing and organizing easy.

Item	Product Description	UOM
54597-SM	Bronze Dentanomic Dental Package - Small Handles	Each
54597-LG	Bronze Dentanomic Dental Package - Large Handles	Each

See **page 56** for more information!

Flexi-Float™ Ultra Complete Kit **PATENTED**

The Flexi-Float™ Ultra is a lightweight, compact, all-in-one, battery-powered float system. The slender design and movable disc angle allows practitioners to maneuver around the dental arcade, along with its shaft which rotates 180 degrees for use on both the upper and lower arcade. This well balanced system has fully integrated irrigation, suction and trigger speed control which allows for quick removal of hooks in the mouth. The Flexi-Float™ Ultra is battery powered making it completely mobile. The rechargeable battery lasts between 8-10 horses. The diamond discs are smoother and last longer than carbide discs and can be quickly changed out in the field, taking less than one minute. Clean daily and grease after every 100 uses.

Kit includes:

- Flexi-Float™ Ultra
- Battery-Powered Vacuum
- Li-Ion Batteries for Vacuum (2)
- Battery Charger for Vacuum
- Irrigation System
- Maintenance Kit
- 14.4-Volt NiMH Rechargeable Batteries (2)
- Battery Charger
- Protective Carrying Case
- Instruction Manual



Item	Product Description	UOM
53050R	Flexi-Float™ Ultra Complete Kit with Remote Wired Battery	Each
53053	Remote Wired Battery for Flexi-Float™ Ultra & Versa-Float™	Each
53054	Battery Charger for Flexi-Float™ Ultra & Versa-Float™	Each

Disc, 1" Diameter, 1/4" Shank, Diamond

- Diamond chip reduces tissue damage
- 1" diameter with 2 holes for easy replacement
- 1/4" -28 Threaded Shank
- Fits Flexi-Float™ Ultra and Versa-Float™ Large Head Shaft

Item	Product Description	UOM
53037	Disc, 1" Diameter, 1/4" -28 Threaded Shank, Diamond	Each



53037

Diastema Burs

- Fits Flexi-Float™ Ultra and Versa-Float™ Large Head Shaft

Item	Product Description	UOM
53038	Diastema Bur #1, Diamond	Each
53039	Diastema Bur #2, Diamond	Each
53040	Diastema Bur #3, Diamond	Each



53038

53039

53040



Versa-Float™ Kits **PATENTED**

The Versa-Float™ Kit is the latest advancement in Equine Dentistry, providing practitioners a mobile instrument to enhance floating techniques. The Versa-Float™ dental system delivers a new standard to power dental instruments. The variable speed unit is controlled by the trigger on the pistol-grip handle, allowing the practitioner more control and accuracy in the mouth. Kit customization available.

Kit includes:

- Versa-Float™ Platform Motor
- Versa-Float™ Large Head Shaft with 1" Diamond Disc
- Versa-Float™ Small Head Shaft with 5/8" Diamond Disc
- Irrigation System for the Large Head Shaft
- Irrigation System for the Small Head Shaft
- Maintenance Kit
- 14.4-Volt NiMH Rechargeable Batteries (2)
- Battery Charger
- Protective Carrying Case
- Instruction Manual



Item	Product Description	UOM
53079R	Versa-Float™ Kit, Large & Small Head Shafts with Platform & Irrigation with Remote Wired Battery	Each
53075R	Versa-Float™ Kit, Large Head Shaft with Platform with Remote Wired Battery	Each
53076R	Versa-Float™ Kit, Large Head Shaft with Platform & Irrigation with Remote Wired Battery	Each
53077R	Versa-Float™ Kit, Small Head Shaft with Platform with Remote Wired Battery	Each
53078R	Versa-Float™ Kit, Small Head Shaft with Platform & Irrigation with Remote Wired Battery	Each
53028	Versa-Float™ Large Head Shaft	Each
53028-I	Versa-Float™ Large Head Shaft with Irrigation Attachment	Each
53029	Versa-Float™ Irrigation Attachment for Large Head Shaft	Each
53030	Versa-Float™ Small Head Shaft	Each
53030-I	Versa-Float™ Small Head Shaft with Irrigation Attachment	Each
53031	Versa-Float™ Irrigation Attachment for Small Head Shaft	Each
53053	Remote Wired Battery for Flexi-Float™ Ultra & Versa-Float™	Each
53054	Battery Charger for Flexi-Float™ Ultra & Versa-Float™	Each

Burs & Discs for Versa-Float™ Dental System - Small Head Shaft



Item	Product Description	UOM
53012	Diastema Bur #1 for Versa-Float™ Small, Diamond	Each
53013	Diastema Bur #2 for Versa-Float™ Small, Diamond	Each
53014	Diastema Bur #3 for Versa-Float™ Small, Diamond	Each
53015	Diastema Bur #4 for Versa-Float™ Small, Diamond	Each
53020	Diamond Disc, 5/8"	Each
53017	Apple Core Bur for Versa-Float™, Small, 1/8" Shank - Diamond	Each
53021	Rotozip Bur, 1/8" Shank, 7/8" LOC, 2" OAL	4/Pack
53044	Bur #2, Style D Special, FG, 1/8" Shank, 1/2" LOC, 3" OAL - Carbide	Each
53044-1	Bur #2, Style D Special, FG, 1/8" Shank, 1/2" LOC, 3" OAL - Carbide	2/Pack
Versa-Float™ Small Head Shaft Accessories		
53032	Versa-Float™ Replacement Head, Small	Each
53033	Versa-Float™ Replacement Collet for Small Head	Each



Burs & Discs for Versa-Float™ Dental System - Large Head Shaft



Item	Product Description	UOM
53037	Disc, 1" Diameter, 1/4" Shank, Diamond	Each
53038	Diastema Bur #1, Diamond	Each
53039	Diastema Bur #2, Diamond	Each
53040	Diastema Bur #3, Diamond	Each



EEZY-MaXX™ Reciprocating Float



A reliable reciprocating float system.

- Low profile allows the user complete maneuverability around the dental arcade
- Excellent for removing caudal hooks and for finishing upper and lower molars
- Pair Reciprocating Shaft Floats with 40 mm (1-1/2") Disposable Blades
- De-MaX™ III reciprocating float shafts are also compatible with EEZY-MaXX™
- Kit includes:
 - EEZY-MaXX™ Reciprocating Float Unit
 - M12 Battery Charger
 - M12 Battery (2)
 - Reciprocating Straight Float Shaft, 19" Working Length
 - Reciprocating Angled Float Shaft, 19" Working Length
 - M12 Shaft Adaptor (2)
 - T-Handle Hex Key 2.5 mm
 - T-Handle Hex Key 3/32"
 - Weatherproof Carrying Case



Item	Product Description	UOM
53120	EEZY-MaXX™ Reciprocating Float Kit	Each
Accessories		
53119	EEZY-MaXX™ Reciprocating Float ONLY	Each
53123	M12 Battery Charger	Each
53124	M12 Battery	Each
53003	Reciprocating Straight Shaft Float, 19" Working Length	Each
53003S	Reciprocating Straight Shaft Float, 13" Working Length	Each
53004	Reciprocating Angled Shaft Float, 19" Working Length	Each
53004S	Reciprocating Angled Shaft Float, 13" Working Length	Each
53121	M12 Shaft Adaptor Kit	Each
53122	M12 Shaft Adaptor Set Screw Kit	5/Pack
53006	Float Blade Set Screw Kit	5/Pack

Power Handle™ Rotary Floats & Accessories



PATENTED

The Power Handle™ instrument is an economical bur power system available in three sizes for accessibility to the incisors, premolars and molars.

- Cylindrical bur models include a removable 2" soft tissue guard which protects the horse's cheek
- Constructed of heavy duty stainless steel
- 5/8" x 2" carbide bur, solid cut
- Powered by a key drive
- Motor sold separately

Item	Product Description	UOM
53089	Power Handle™ Rotary Float, 17-1/2" Length, 90 Degree, 1" Diamond Disc	Each
53090	Power Handle™ Rotary Float, 7-1/2" Length, Cylindrical Bur	Each
53091	Power Handle™ Rotary Float, 10" Length, Cylindrical Bur	Each
53092	Power Handle™ Rotary Float, 17-1/2" Length, Cylindrical Bur	Each
53093	Cylindrical Bur, 5/8" Diameter, 2" Length, Carbide	Each
53094	Cylindrical Bur, 5/8" Diameter, 2" Length, Diamond	Each



EQ Power Float™



The EQ Power Float™ measures 19 inches in length and features a low profile 90 degree head. It is significantly lighter than most on the market today, weighing under 1.5 lbs. The EQ Power Float™ is built in-house with high quality aluminum and stainless steel. It includes a Nickel Braised 1-1/4" Disk and Guard with a choice of Key Drive or Square Drive.

Item	Product Description	UOM
58102	EQ Power Float™ - Key Drive	Each
58103	EQ Power Float™ - Square Drive	Each



EQ Mini Power Float™

The EQ Mini Power Float™ measures 8.5 inches in length and features a low profile 90 degree head. Small and easy to maneuver, the EQ Mini Power Float™ is ideal for work on incisors and canines. The EQ Mini Power Float™ is built in-house with high quality aluminum and stainless steel. Includes Nickel Braided Canine / Apple Core Combo Bur and choice of Key Drive or Square Drive.

Item	Product Description	UOM
58104	EQ Mini Power Float™ - Key Drive	Each
58106	EQ Mini Power Float™ - Square Drive	Each

*Tools to change disk not included, must be ordered separately. Call for more information.

Mighty EZ Float™ Kits

The Mighty EZ Float™ is a lightweight, battery-powered unit. Featuring an On/Off switch, variable speed control and a built-in clutch. The Mighty EZ Float™ offers all of the standard features in a convenient, cordless unit.

Kit includes:

- 2 Rechargeable Li-Ion Batteries
- Wall Charger Unit
- 43" or 66" Key Drive or Square Drive Complete Cable Assembly
- Convenient Carrying Case

Item	Product Description	UOM
58110	Mighty EZ Float™ Kit - Key Drive, 43"	Each
58111	Mighty EZ Float™ Kit - Square Drive, 43"	Each
58108	Mighty EZ Float™ Kit - Key Drive, 66"	Each
58109	Mighty EZ Float™ Kit - Square Drive, 66"	Each

Quick Float™ Kit

The Quick Float™ Kit is the ultimate cordless power set up. Lightweight, at about 2 lbs, the Quick Float™ is easy to use anywhere. Ideal for locations with no available power source. Includes 2 Li-Ion batteries, each battery lasting up to five horses.

Standard Kit includes:

- Quick Float™ Motor
- Quick Float™ Wand
- 2 Rechargeable Li-Ion Batteries - 1 M12 2.0 battery and 1 M12 6.0 battery
- Wall Charger Unit
- Lubricant
- Lube Gun
- Disk Pliers
- T-Wrench
- Nickel Braided Apple Core Bur
- Nickel Braided 1-1/4" Disk and Guard
- Convenient Carrying Case

Item	Product Description	UOM
58100	Quick Float™ Kit	Each
58122	Replacement Float Wand	Each
58123	Replacement Float Wand - Mini	Each

Jerry's Powered Float Accessories

Item	Product Description	UOM
58125	Jerry's Key Drive T-Wrench	Each
58126	Jerry's Square Drive T-Wrench	Each
58135	1-1/4" Nickel Braided Disk	Each
58136	Nickel Braided Apple Core Bur	Each



Jerry's Powered Float Accessories



Item	Product Description	UOM
58137	Nickel Braised Small Ball Nose Apple Core Bur	Each
58138	Nickel Braised Large Ball Nose Apple Core Bur	Each
58139	Nickel Braised Buccal Bur	Each
58140	1" Nickel Braised Disk and Guard Kit	Each
58141	Nickel Braised 5/8" Canine / Apple Core Combo Bur	Each
58142	Nickel Braised 1/2" Canine / Apple Core Combo Bur	Each
58143	Disc Guard, 1-1/4"	Each
53475	Disc Wrench	Each



Power Motor with Foot Pedal



- Low cost, high value power motor comparable in durability to Foredom™
- Powerful, compact and lightweight
- Available in either 110-Volt or 220-Volt

Item	Product Description	UOM
53096	Power Motor with Foot Pedal	Each



Foredom™ Motors



- Key drive power shaft is compatible with discontinued Dremel® products
- Variable speed controlled by foot pedal
- Heavy duty, high power unit
- Delivers more torque with complete control throughout the entire speed range allowing for greater control of the bur

Item	Product Description	UOM
58058	Foredom™ TX-SXR 1/3 HP Motor with Foot Pedal - Key Drive	Each
58059	Foredom™ SR-SCT 1/6 HP Motor with Foot Pedal - Square Drive	Each
58075	Foredom™ 63" Inner Cable, Square Drive	Each
58076	Foredom™ 63" Outer Cable, Square Drive	Each
58077	Foredom™ 39" Inner Cable, Key Drive	Each
58079	Foredom™ 39" Outer Cable, Key Drive	Each
58078	Foredom™ 66" Inner Cable, Key Drive - Non-conductive	Each
58080	Foredom™ 66" Outer Cable, Key Drive	Each
58073	Foredom™ 45-3/4" Inner Cable, Square Drive - Non-conductive	Each
58074	Foredom™ 45-3/4" Outer Cable, Square Drive - Non-conductive	Each



DREMEL is a registered trademark of Robert Bosch Tool Corporation.

EEZY-Drive™ Pro Motor System



New and improved! A compact, lightweight all-in-one battery-powered system for equine dentistry.

Features:

- | | |
|---|---|
| <ul style="list-style-type: none"> • Quiet motor / driver unit • Low voltage DC motor / driver • Independent system power On/Off switch • Independent variable speed control dial • Operating range of 800 - 7,500 RPM • Li-Ion battery, 25.9-Volt, 3.6 amp-hours • Battery fully charges in 1.5 hours • Battery runtime lasts an average of 10 horses • 39" keyed drive - use with any key-driven handpiece | <p>System includes:</p> <ul style="list-style-type: none"> • System Control Motor Driver Unit Assembly • Charger Assembly • (2) Battery Assembly • Waist Belt - Complete Assembly • (2) Waist Belt Options • Foredom™ Cable Assembly - Installed 39" Key Drive • Travel Case |
|---|---|

Item	Product Description	UOM
53152	EEZY-Drive™ Pro Motor System	Each

*Shown with handpiece attached for demonstration purposes only.



Equine Dental Systems Polyfloat & Accessories



Item	Product Description	UOM
53163	EDS Polyfloat Straight, Key Drive, Short - 15 cm Shaft Length (without Bur)	Each
53164	EDS Polyfloat Straight, Key Drive, Standard - 25 cm Shaft Length (without Bur)	Each
53165	EDS Polyfloat Straight, Key Drive, Long - 37 cm Shaft Length (without Bur)	Each
53166	EDS Polyfloat Curved, Key Drive, Standard - 25 cm Shaft Length (without Bur)	Each
53167	EDS Polyfloat Curved, Key Drive, Long - 37 cm Shaft Length (without Bur)	Each



53163

Polyfloat Burs



Item	Product Description	UOM
53168	Polyfloat Applecore Bur, Canine - 18 mm Diameter	Each
53169	Polyfloat Applecore Bur - 14 mm Diameter	Each
53170	Polyfloat Applecore Bur - 18 mm Diameter	Each
53171	Polyfloat Applecore Bur - 22 mm Diameter	Each
53172	Polyfloat Occlusal Bur - 17 mm Diameter	Each
53173	Polyfloat Cylindrical Bur - 14 mm Length	Each
53174	Polyfloat Cylindrical Bur - 27 mm Length	Each
53175	Polyfloat Versatile Cylindrical Bur - 20 mm Length	Each
53176	Polyfloat Versatile Cylindrical Bur - 25 mm Length	Each
53177	Polyfloat Conical Bur - 10 mm Length	Each
53178	Polyfloat Conical Bur - 15 mm Length	Each



53171



53173



53175



53178

Equine Dental Systems Flexidisc



Item	Product Description	UOM
53180	EDS Flexidisc, Straight, Key Drive, Short - 15 cm Shaft Length	Each
53181	EDS Flexidisc, Straight, Key Drive, Standard - 25 cm Shaft Length	Each
53182	EDS Flexidisc, Straight, Key Drive, Long - 37 cm Shaft Length	Each
53183	EDS Flexidisc, Curved TWIST, Key Drive, Standard	Each
53184	EDS Flexidisc, Curved TWIST, Key Drive, Long	Each



53180

Handpiece Drills



Item	Product Description	UOM
53185	Maxillary Drill	Each
53186	Mandibular Drill	Each
53187	Angle Drill	Each
53188	Bowl Drill	Each
53189	Disc Drill	Each
53190	Special Bit-Seat Drill	Each
53191	Special Canine Drill	Each



53187



Equine Periodontal System & Accessories

The Equine Periodontal System is used for the diagnosis and treatment of periodontal disease and endodontic procedures in horses. System is complete and ready to use - the user only needs to supply a tank of nitrogen.

- High Speed Handpiece with an equine extension
- Low Speed Handpiece
- Air / Water Handpiece with both short and long tips
- Air Abrasion Handpiece - NEW!
- Vacuum handpiece
- Low Speed handpiece
- Can be operated using Nitrogen or compressed air
- Nitrogen regulator may be purchased separately
- Mobile cart may be purchased separately

Item	Product Description	UOM
53062	Equine Periodontal System (without Cart and Nitrogen Regulator)	Each
53060	Equine Periodontal System with Cart and Nitrogen Regulator	Each
53061	Equine Periodontal Cart	Each

Versa Air Abrasion Handpiece

Item	Product Description	UOM
53068	Versa Air Abrasion Handpiece	Each

High Speed, High Torque Handpiece

Item	Product Description	UOM
53130	High Speed, High Torque Handpiece - 350,000 RPM	Each

High Speed Extension

Item	Product Description	UOM
53069	High Speed Extension - Midwest 4 Hole Coupling	Each

Low Speed Handpiece

Item	Product Description	UOM
53132	Low Speed Handpiece	Each

Replacement Turbine for High Speed, High Torque Handpiece

Item	Product Description	UOM
53131	Replacement Turbine for High Speed, High Torque Handpiece	Each

3-Way Syringe with Short Tip

Item	Product Description	UOM
53065	3-Way Syringe with Short Tip	Each

Extended Syringe Tip

Item	Product Description	UOM
53067	Extended Syringe Tip - Tip Only	Each

Water Bottle for Dental Cart - 1 Liter

Item	Product Description	UOM
54925	Water Bottle for Dental Cart - 1 Liter	Each



Equine Periodontal System Accessories

Tapered Fissure Bur #702L, Surgical, FG, 25 mm - Carbide

Item	Product Description	UOM
54812	Tapered Fissure Bur #702L, Surgical, FG, 25 mm - Carbide	5/Pack



Round Tip Bur #8, FG, Surgical, 25 mm - Carbide

Item	Product Description	UOM
53042	Round Tip Bur #8, FG, Surgical, 25 mm - Carbide	5/Pack



Acid Etch Gel

Item	Product Description	UOM
54604	Acid Etch Gel, 1.2 ml	4/Pack



ProFil™ Flowable Composite

Item	Product Description	UOM
54605	ProFil™ Flowable Composite, 1 gram	4/Pack



ProLink™ Bonding Agent

Item	Product Description	UOM
54606	ProLink™ Bonding Agent, 5 ml	Each



Impression Material

Item	Product Description	UOM
54612	Impression Material, Slow Set, 50 ml	Each
54613	Impression Material, Fast Set, 50 ml	Each



Mixing Tip

Item	Product Description	UOM
53742	Mixing Tip	Each



Intra Oral Tip

- Used with Mixing Tip (Item #53742)

Item	Product Description	UOM
53752	Intra Oral Tip	10/Pack



High Performance Mixing Gun

Item	Product Description	UOM
54608	High Performance Mixing Gun for Impression Material & Acrylic	Each



Bio Lube® Lubricant Pen

Item	Product Description	UOM
54882	Bio Lube® Lubricant Pen, .25 oz	Each



Buccotomy Sets

A surgical approach via a cannula through the cheek to gain access to an intra oral extraction procedure. Courses pertinent to the technique of Minimally Invasive Buccotomy are recommended.

- Gunther Speculum is necessary for the procedure
- Made in the USA
- All components are autoclavable and are constructed of stainless steel
- **Replacement pieces sold separately**

Item	Product Description	UOM
53540	Buccotomy Set - Complete Kit with Plastic Case	Each
53545	Buccotomy Set - Starter Kit with Plastic Case	Each



53540



53545

NOTE:

Gunther Speculum is Required when performing a **Buccotomy procedure**.

Gunther Speculum

Item	Product Description	UOM
53612	Gunther Speculum	Each



Equine Dental Scope System

Used during equine dental examinations for cleaning, floating, extractions and related procedures. Improves visualization and accuracy during examinations.

Kit includes:

- Dental Scope
- Water Sleeve
- High-Resolution USB Endoscopy Camera
- Focusing Endoscope Coupler
- Portable Light Source
- Endoscope Video Adaptor for iPod Touch

Optional Add-Ons:

- 50-Watt LED Light Source
- Light Guide for 50-Watt LED Light Source

Item	Product Description	UOM
48056	Dental Scope System with 8mm x 380mm Scope, Diagnostic Sheath, USB Camera and Endoscope Coupler	Each
48036	Scope	Each
48045	Diagnostic Sheath (Water Sleeve) for 5.5 mm x 380 mm, 70 Degree	Each
48201	High-Resolution USB Endoscopy Camera	Each
48203	Focusing Endoscope Coupler	Each
48043	Endoscope Video Adaptor for iPod Touch	Each
Optional Add-Ons		
48304	50-Watt LED Light Source	Each
48217	Light Guide for 50-Watt LED Light Source	Each



48036

48056



48043

48203



48201

48304



48217



X Spec™ Equine Speculum, Wide



- Next generation equine speculum, an enhancement of the original AlumiSpec™, known and trusted throughout the industry
- Wider design provides more space between the horse's cheek and speculum to accommodate digital radiography plates for obtaining dental films in a variety of positions
- Constructed of aircraft grade and lightweight aluminum, CNC milled precision pieces, TIG welded with a powder coated finish
- Use of replaceable synthetic straps in the "cinch-lock" locking system allows for infinite degrees of access to the patient's oral cavity
- May be used on all sizes of horses from miniature to draft
- Recommended for use with sedated animals for the safety of the handler and the horse
- Tested on hundreds of patients in an equine dental practice
- Net weight 6 lbs
- Replacement Bolt Kit includes equipment to replace one side only



Item	Product Description	UOM
53605	X Spec™ Equine Speculum	Each
53602	Replacement Opening Latch Strap for AlumiSpec™ & X Spec™	Each
53603	Cam Buckle for Opening Latch Strap for AlumiSpec™ & X Spec™	Each
53606	Replacement Bite Plate Pads with Holes for X Spec™ (Set of 2)	Each
53676	Replacement Poll Strap for AlumiSpec™ & X Spec™	Each
53675	Replacement Bolt Kit for AlumiSpec™ & X Spec™ - for One Side	Each

AlumiSpec™



- Constructed of aircraft grade and lightweight aluminum
- Durability is not compromised by lightweight design - able to withstand bending forces in dental procedures
- Use of replaceable synthetic straps in the "cinch-lock" locking system allows for infinite degrees of access to the patient's oral cavity
- Easy to clean and is pliable at all temperatures
- May be used on all sizes of horses from miniature to draft
- Recommended for use with sedated animals for the safety of the handler and horse
- Net weight 6 lbs
- Replacement Bolt Kit includes equipment to replace one side only



Item	Product Description	UOM
53600	AlumiSpec™ Equine Speculum	Each
53601	Replacement Bite Plate Pads with Holes for AlumiSpec™	Each
53602	Replacement Opening Latch Strap for AlumiSpec™ & X Spec™	Each
53603	Cam Buckle for Opening Latch Strap for AlumiSpec™ & X Spec™	Each
53676	Replacement Poll Strap for AlumiSpec™ & X Spec™	Each
53675	Replacement Bolt Kit for AlumiSpec™ & X Spec™ - for One Side	Each

Pacific Edge™ Mouth Speculum



Item	Product Description	UOM
53610	Pacific Edge™ Mouth Speculum with Biothane Straps, Polished Finish	Each



EZ Spec™ Mouth Speculum



PATENTED

The EZ Spec™ Mouth Speculum is made of lightweight, durable, aircraft-grade aluminum and has a net weight of 6 lbs. This speculum is strong enough to withstand dental procedures. It features a no-slip cam buckle for easy and unlimited adjustments with a safety lock feature.

Item	Product Description	UOM
53607	EZ Spec™ Mouth Speculum	Each



Mini EZ Spec™ Mouth Speculum



PATENTED

The Mini EZ Spec™ Mouth Speculum is made of lightweight, durable, aircraft-grade aluminum. Even though it weighs less than 3.5 lbs, this speculum is strong enough to stand up to any job. It features a no-slip cam buckle for easy and unlimited adjustments. We have also added a safety lock feature to ensure your safety no matter how strong the horse. Also great for x-rays.

Item	Product Description	UOM
53608	Mini EZ Spec™ Mouth Speculum	Each



Magnetic Spec BiteLite™ Accessories



Item	Product Description	UOM
53425-1	Magnetic Speculum Plate	Each
53425-2	Replacement Battery Box	Each



Additional Headlight Options Available - See Pages 158-159

Harlton's Mouth Wedge



- Unique design allows several teeth to rest on the wedge at a time, reducing the danger of cracking

Item	Product Description	UOM
53689	Harlton's Mouth Wedge	Each



Equine Cheek Retractor



This Equine Cheek Retractor, or spreader, is designed to gently pull the cheeks away from the cheek teeth so occlusion can be evaluated on a closed mouth. It is also useful for providing more room when using power dentistry equipment. The stainless steel design features two offsetting size retractors, one large and one small, that can be easily alternated by simply turning the retractor around.

Item	Product Description	UOM
53615	Equine Cheek Retractor	Each





Dental Halter System

The Dental Halter System includes a dental halter and fiddle block along with a pulley and rope.

Item	Product Description	UOM
51802	Dental Halter System	Each



Equine Radiography Top



Item	Product Description	UOM
53427	Equine Radiography Top (fits Standard & Cradle Style Base)	Each



Equine Head Rest, Standard Style



- Constructed of lightweight aluminum
- Choice of manual lift or self-elevating Quik Lift
- Features a tip resistant base, twist-proof square shank and height adjustable lock
- Powder coated for ease in clean up
- Quickly disassembled for transportation or storage
- Traditional round style resting pad
- Compact and easy to store
- Height Range:

53430 - Min 43", Max 68"

53430QL - Min 44", Max 59"

Item	Product Description	UOM
53430	Equine Head Rest & Base, Standard Style	Each
53430QL	Quik Lift Equine Head Rest, Standard Style	Each
53437	Replacement Cover & Pad, Standard Style	Each



Equine Head Rest, Cradle Style



- Constructed of lightweight aluminum
- Choice of manual lift or self-elevating Quik Lift
- Features a tip resistant base, twist-proof square shank and height adjustable lock
- Powder coated for ease in clean up
- Quickly disassembled for transportation or storage
- Large padded platform provides a large resting area for horse's head
- Platform with gradually sloping sides holds the sedated horse more securely and places less strain on the mandible
- Compact and easy to store
- Height Range:

53433 - Min 43", Max 68"

53433QL - Min 44", Max 59"

Item	Product Description	UOM
53433	Equine Head Rest & Base, Cradle Style	Each
53433QL	Quik Lift Equine Head Rest, Cradle Style	Each
53434	Replacement Cover & Pad, Cradle Style	Each



Mini & Pony Head Rests

Head rests specifically designed to accommodate horses ranging between mini and pony sizes. Existing head rests can also be converted to accommodate mini and pony horses with #53444 and #53446.

- Constructed of lightweight aluminum
- Features a tip resistant base, twist-proof square shank and height adjustable lock
- Powder coated for ease in clean up
- Quickly disassembled for transportation or storage
- Complete with individual post and individual 6" extension to accommodate various ranges between mini and pony
- Compact and easy to store
- Height Range:

#53441 and #53442 - Min 26", Max 36" (without 6" extension)

Item	Product Description	UOM
53441	Mini & Pony Head Rest & Base, Standard Style	Each
53442	Mini & Pony Head Rest & Base, Cradle Style	Each
53443	Mini & Pony Head Rest & Base with Post Assembly & 6" Extension	Each
53444	Mini & Pony Head Rest Post Assembly	Each
53446	Mini & Pony Head Rest 6" Extension	Each



Quik Lift Conversion Post

- Constructed of lightweight aluminum
- Powder coated for ease in clean up
- Self rising
- Converts Standard & Cradle Style Head Rests to a Quik Lift Head Rest
- Includes inner post, outer post, handle and 2 spring pins

Item	Product Description	UOM
53438	Quik Lift Conversion Post (only fits Standard & Cradle Style Base)	Each



Equine Cadaver Head Holder

- Sturdy holder for cadaver heads used for educational purposes

Item	Product Description	UOM
53401	Equine Cadaver Head Holder (fits Standard & Cradle Style Base)	Each
53402	Equine Cadaver Head Holder & Base	Each
53429	Equine Head Stand Base	Each



Equine Head Rest, Suspended Style **PATENTED**

- Provides excellent and safe support for the sedated horse's head during all dental procedures, ophthalmic exams or cranial surgeries
- Provides adjustable cranial elevation that is self-locking, secure and stable, yet allows for mild swaying and is comfortable and safe for the patient
- Designed to be suspended from a beam or rafter using a chain or rope or suspended from stocks
- Cam cleat rope adjuster allows quick variable height adjustments using a self-locking quick release mechanism
- Includes high quality foam pad, vinyl cover and hardware

Item	Product Description	UOM
53431	Equine Head Rest, Suspended Style	Each
53436	Replacement Cover & Pad, Suspended Style	Each



Equine Diagnostic Kit

Kit includes:

- The Edge Equine™ Mouth Mirror
- Replacement Mouth Mirror
- The Edge Equine™ Dental Pick
- VDP Equine Periodontal Pick with 3 Needle Picks
- 11" Alligator Forceps
- Periodontal Probe
- Explorer
- Carrying Case
- Optional Scaler and Elevators are sold separately



Item	Product Description	UOM
53400	Equine Diagnostic Kit	Each

The Edge Equine™ Equine Periodontal Pick

- Design is based on human periodontal instruments with an extended handle for equine use
- Constructed of premium quality stainless steel



53417

Item	Product Description	UOM
53417	The Edge Equine™ Dental Pick	Each
53418	The Edge Equine™ Replacement Needle Picks	3/Pack

Equine Periodontal Pick Set

Item	Product Description	UOM
53405	Equine Periodontal Pick - includes 3 Needle Picks	Each
53410	Equine Periodontal Pick Set - includes 6 Needle Picks	Each
53405-R	Replacement Needle Picks	3/Pack



53410

Equine Dental Probe

- Banded probe to measure pulp chambers and pockets
- Length 14"

Item	Product Description	UOM
53406	Equine Dental Probe	Each

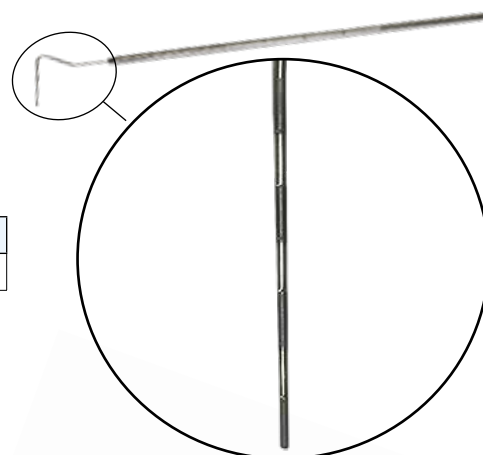

Alligator Forceps

- Length 11"

Item	Product Description	UOM
53412	Alligator Forceps	Each



Equine Fine Point Periodontal Forceps



- Double acting design allows room to work in the tight confines of the horse's mouth
- Rugged design performs as expected for years of use
- Small tip at 90 degrees allows food to be evacuated from tight spaces between the horse's teeth
- Non-locking design allows easy use with one hand
- Stainless steel for easy clean up and care
- Length 16"

Item	Product Description	UOM
53419	Equine Fine Point Periodontal Forceps	Each



The Edge Equine™ Mouth Mirror, T-Handle



- Specifically designed for equine dentistry
- Features oval mirror on a 19" long shaft
- Rigid enough to hold tongue aside during examination

Item	Product Description	UOM
53415	The Edge Equine™ Mouth Mirror, T-Handle, 19" Long Mirror, Oval	Each
53416	The Edge Equine™ Replacement Mouth Mirror with Tape, Oval	Each



Equine Mouth Mirror, T-Handle, Round Mirror

Item	Product Description	UOM
53407	Equine Mouth Mirror, T-Handle, 19" Long Mirror, Round	Each
53414	Replacement Mouth Mirror with Tape, Round	Each



Gingival Elevator Set, T-Handle



- Designed to loosen the gingiva from the tooth before extraction
- Includes 2 curvatures for the lingual and buccal position

Item	Product Description	UOM
53655	Gingival Elevator Set, T-Handle	Each



Equine Dental Scaler, T-Handle



- Length 13"

Item	Product Description	UOM
53408	Equine Dental Scaler, T-Handle	Each



Equine Dental Explorer



- Length 13"

Item	Product Description	UOM
53409	Equine Dental Explorer	Each



Extended Wolf Tooth Elevator Set

- Designed to be used with a speculum
- Set includes right and left configuration elevator

Item	Product Description	UOM
53653	Extended Wolf Tooth Elevator Set - Length 13.75"	Each
53653S	Extended Wolf Tooth Elevator Set, Short - Length 12.75"	Each



Extended Molar / Fragment Elevator Set

- Designed to remove a tooth fragment from an extracted molar's socket
- Set includes 4 configurations: vestibular, mesial, distal and lingual
- Elevator blade height provides the leverage needed to remove fragments
- Constructed of stainless steel
- Made in the USA

Item	Product Description	UOM
53654	Extended Molar / Fragment Elevator Set - Length 22", 3.5" Elevator Height	Each
53654S	Extended Molar / Fragment Elevator Set, Short - Length 22", 2" Elevator Height	Each

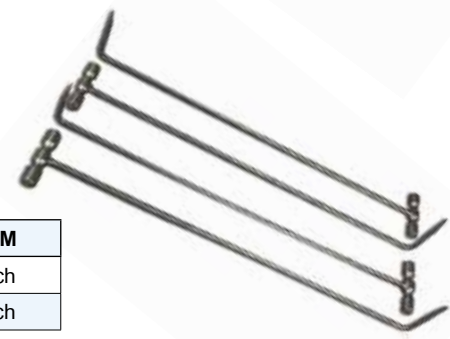

550 ml Syringe

- All plastic construction
- 550 ml maximum capacity
- Length 15.5"
- Polypropylene graduated barrel
- Durable plunger system for ease in filling and dispensing
- Used for oral delivery of fluids and medicants including nutritionals
- Ideal for oral rinsing in Equine Dentistry
- Includes standard plastic oral nozzle, stainless steel also available separately
- Removable caps on both ends of the barrel for ease in assembly, disassembly and cleaning

Item	Product Description	UOM
60400	550 ml Syringe	Each
70860	Nozzle, Long Drench - Stainless Steel with .280" Inside Diameter	Each



The Edge Equine™ Water Pick Kits & Accessories

- Ideal for dislodging impacted food from diastemata
- Constructed of acetyl, stainless steel and brass
- Wand, handle and water pick may be purchased separately

Item	Product Description	UOM
53762	The Edge Equine™ Quick Change Water Pick & Flushing Wand Kit with Bottle	Each
53763	The Edge Equine™ Quick Change Water Pick & Flushing Wand with Tubing Assembly	Each
53764	The Edge Equine™ Quick Change Flushing Wand	Each
53765	The Edge Equine™ Quick Change Handle	Each
53766	The Edge Equine™ Quick Change Water Pick	Each



Direct Spray Pattern

Wide Spray Pattern



53763



53762



Incisor & Wolf Tooth Elevator Set

Item	Product Description	UOM
53649	Incisor & Wolf Tooth Elevator Set	Each



Incisor Elevator Set

- Various curvatures for incisor extractions

Item	Product Description	UOM
53645	Incisor Elevator (Set of 6)	Each
53646	Incisor Elevator (Set of 3)	Each



Swartz Wolf Tooth Elevator

Item	Product Description	UOM
53657	Swartz Wolf Tooth Elevator	Each



Gary's Cap Extractor

Item	Product Description	UOM
53569	Gary's Cap Extractor - Upper	Each
53570	Gary's Cap Extractor - Lower	Each



Dentanomic Modular Dental Instruments - Equine

Dentanomic Ergonomic Handles

Item	Product Description	UOM
Dentanomic Ergonomic Handles - Small (for glove size < 7.5)		
54542-SMGN	Dentanomic Small Ergonomic Handle - Green	Each
54542-SMPK	Dentanomic Small Ergonomic Handle - Pink	Each
54542-SMBL	Dentanomic Small Ergonomic Handle - Blue	Each
54542-SMGD	Dentanomic Small Ergonomic Handle - Gold	Each
54542-SMPR	Dentanomic Small Ergonomic Handle - Purple	Each
Dentanomic Ergonomic Handles - Large (for glove size > 7.5)		
54542-LGGN	Dentanomic Large Ergonomic Handle - Green	Each
54542-LGPK	Dentanomic Large Ergonomic Handle - Pink	Each
54542-LGBL	Dentanomic Large Ergonomic Handle - Blue	Each
54542-LGGD	Dentanomic Large Ergonomic Handle - Gold	Each
54542-LGPR	Dentanomic Large Ergonomic Handle - Purple	Each



Dentanomic Equine Luxation Blades

- Length 3"

Item	Product Description	UOM
53460-4	Dentanomic Equine Luxation Blade, 4 mm	Each
53460-5	Dentanomic Equine Luxation Blade, 5 mm	Each



Dentanomic Equine Contra Angle Blades

- Length 3"

Item	Product Description	UOM
53461-4	Dentanomic Equine Contra Angle Blade, 4 mm	Each
53461-5	Dentanomic Equine Contra Angle Blade, 5 mm	Each



Adjustable Wolf Tooth Elevator

Item	Product Description	UOM
53658	Adjustable Wolf Tooth Elevator, Economy Blade & Handle	Each



Martel Wolf Tooth Elevators

- Martel Wolf Tooth Elevators have a weighted brass handle and stainless steel blade to provide the ideal balance for removing hard to reach wolf teeth
- Two styles available, straight and angled
- Measures 3" overall with a shaft length of 2"
- Ball handle is 1-3/8" in diameter
- Set of 2 includes: 1 Straight Elevator and 1 Angled Elevator

Item	Product Description	UOM
53650	Martel Wolf Tooth Elevator, Straight	Each
53651	Martel Wolf Tooth Elevator, Angled	Each
53652	Martel Wolf Tooth Elevator, Set of 2	Each



"MS" Wolf Tooth Elevators

Item	Product Description	UOM
53663	"MS" Wolf Tooth Elevator Set, 8 mm & 10 mm	Each
53664	"MS" Wolf Tooth Elevator, 10 mm	Each
53665	"MS" Wolf Tooth Elevator, 8 mm	Each



Fragment Forceps, Heavy

- Jaw length 2"

Item	Product Description	UOM
53523	Fragment Forceps, Heavy	Each



Upper & Lower Separating Forceps

Item	Product Description	UOM
53550	Upper & Lower Separating Forceps	Each



Wolf Tooth Forceps

- Effective for wolf tooth and incisor extractions

Item	Product Description	UOM
53520	Wolf Tooth Forceps	Each



Large Extraction Forceps, 19"

- Concave knurled contact surface securely grips tooth

Item	Product Description	UOM
53521	Large Extraction Forceps, 19" Length	Each



4-Prong Extraction Forceps



- Ideal forceps with excellent grip
- Grips short crowned geriatric and some fractured teeth

Item	Product Description	UOM
53510	4-Prong Extraction Forceps, 19" Length	Each



4-Prong Extraction Forceps, Pony



- Small jaws allow access to pony mouths

Item	Product Description	UOM
53511	4-Prong Extraction Forceps, Pony, 19" Length	Each



Extraction Forceps, Duckbill



Item	Product Description	UOM
53527	Extraction Forceps, Duckbill	Each



3-Prong Extractor



Item	Product Description	UOM
53565	3-Prong Extractor, Left, 19" Length	Each
53566	3-Prong Extractor, Right, 19" Length	Each



4-Prong Extractors, Mid with Fulcrum



- Fulcrum location aids in extraction of second and some third premolars

Item	Product Description	UOM
53512	4-Prong Extractor, Mid with Fulcrum, Mandibulary Straight	Each
53513	4-Prong Extractor, Mid with Fulcrum, Maxillary Curved	Each



Fragment Forceps



- Jaw length 2"

Item	Product Description	UOM
53522	Fragment Forceps, 19" Length	Each



Fragment Forceps, Slim



- Provides access to fragments deep in the alveolus

Item	Product Description	UOM
53524	Fragment Forceps, Slim, 4 cm	Each
53525	Fragment Forceps, Slim, 6 cm	Each
53526	Fragment Forceps, Slim, 8 cm	Each



Equine Extraction Kit



- 4-Prong Extraction Forceps
- Standard Spreader, 3 mm
- Gingival Elevator Set, T-Handle (Set of 2)

Item	Product Description	UOM
53505	Equine Extraction Kit	Each



Hewson's Cap Extractor

Item	Product Description	UOM
53564	Hewson's Cap Extractor - Large Head, 13" Length	Each



Fulcrum Set

- Multiple fulcrum heads fit most extraction needs
- Angled and notched surface keeps fulcrum in place

Item	Product Description	UOM
53528	Fulcrum Set	Each



The Edge Equine™ Locking Fulcrum Set

Item	Product Description	UOM
53529	The Edge Equine™ Locking Fulcrum Set	Each

3-Head Fulcrum Set

Item	Product Description	UOM
53588	3-Head Fulcrum Set	Each



Gerzog Orthopedic Mallet

Item	Product Description	UOM
53593	Gerzog Orthopedic Mallet	Each



Hibbs Osteotome

Item	Product Description	UOM
53591	Hibbs Osteotome - Straight Head	Each
53592	Hibbs Osteotome - Curved Head	Each



Pony Spreader

Item	Product Description	UOM
53514	Pony Spreader, 19" Length	Each



Standard Spreaders

- Specifically designed to keep most of the pressure on the tooth designated for extraction

Item	Product Description	UOM
53515	Standard Spreader, 3 mm	Each
53518	Standard Spreader, 6 mm	Each



Mesial Spreaders

- Specifically designed to keep most of the pressure on the tooth designated for extraction

Item	Product Description	UOM
53516	Mesial Spreader, 3 mm	Each
53517	Mesial Spreader, 6 mm	Each
53519	Mesial Spreader, 9 mm	Each



The Edge Equine™ Floats



- Lighter in weight than traditional floats with blades
- Lower in profile than traditional floats
- Smaller blades for easier maneuverability than traditional floats
- Blades available in a range of sizes, shapes and grades
- Available in 24 lengths with various angle / degree configurations
- Individual floats do not include blades

The Edge Equine™ Float Measurement Guide

Overall Length = Head + Shaft



The Edge Equine™ Float Starter Kit

- Starter Kit includes floats #53209, #53220, #53221, #53225, blades #53008, #53252, #53227, #58200 and carrying bag

Item	Product Description	UOM
53005	The Edge Equine™ Float Starter Kit, includes Blades	Each
53007	The Edge Equine™ Roll Up Carrying Bag, Vinyl	Each



Floats Recommended for No. 1 Upper & Lower Premolars



The Edge Equine™ Dental Float, -27 Degree Head, 13-1/4" Length

Item	Product Description	UOM
53229	The Edge Equine™ Dental Float, -27 Degree Head, 13-1/4" Length 1/2" Stainless Tubing, E-Series 40 mm (1-1/2") Blade	Each



The Edge Equine™ Dental Float, -27 Degree Head, 14" Length

Item	Product Description	UOM
53230	The Edge Equine™ Dental Float, -27 Degree Head, 14" Length 1/2" Stainless Tubing, E-Series 50 mm (2") Blade	Each



The Edge Equine™ Dental Float, -6 Degree Head, 14" Length

Item	Product Description	UOM
53209	The Edge Equine™ Dental Float, -6 Degree Head, 14" Length 3/8" Stainless Rod, S-Series 40 mm (1-1/2") Blade	Each



The Edge Equine™ Dental Float, -6 Degree Head, 15" Length

Item	Product Description	UOM
53218	The Edge Equine™ Dental Float, -6 Degree Head, 15" Length 3/8" Stainless Rod, S-Series 50 mm (2") Blade	Each



The Edge Equine™ Dental Float, -6 Degree Head, 16-1/2" Length

Item	Product Description	UOM
53222	The Edge Equine™ Dental Float, -6 Degree Head, 16-1/2" Length 3/8" Stainless Rod, S-Series 50 mm (2") Blade	Each



Floats Recommended for No. 1, No. 2, No. 3 Upper & No. 1 Lower Premolars



The Edge Equine™ Dental Float, -18 Degree Head, 15" Length

Item	Product Description	UOM
53231	The Edge Equine™ Dental Float, -18 Degree Head, 15" Length 5/8" Stainless Tubing, E-Series 50 mm (2") Blade	Each



The Edge Equine™ Dental Float, -18 Degree Head, 16" Length

Item	Product Description	UOM
53232	The Edge Equine™ Dental Float, -18 Degree Head, 16" Length 5/8" Stainless Tubing, L-Series 83 mm (3-1/4") Blade	Each



The Edge Equine™ Dental Float, -18 Degree Head, 17" Length

Item	Product Description	UOM
53235	The Edge Equine™ Dental Float, -18 Degree Head, 17" Length 1/2" Stainless Tubing, E-Series 50 mm (2") Blade	Each



The Edge Equine™ Dental Float, -24 Degree Head, 15" Length

Item	Product Description	UOM
53219	The Edge Equine™ Dental Float, -24 Degree Head, 15" Length 3/8" Stainless Rod, S-Series 50 mm (2") Blade	Each



Floats Recommended for Upper No. 6 Cheek Teeth Rear Molars



The Edge Equine™ Dental Float, +6 Degree Head, 20" Length

Item	Product Description	UOM
53240	The Edge Equine™ Dental Float, +6 Degree Head, 20" Length 1/2" Stainless Tubing, E-Series 40 mm (1-1/2") Blade	Each



The Edge Equine™ Dental Float, +6 Degree Head, 20" Length

Item	Product Description	UOM
53241	The Edge Equine™ Dental Float, +6 Degree Head, 20" Length 3/8" Stainless Rod, E-Series 40 mm (1-1/2") Blade	Each



Floats Recommended for Upper No. 3 to No. 6 & Triadan Nomenclature



The Edge Equine™ Dental Float, +2 Degree Head, 20-1/2" Length

Item	Product Description	UOM
53236	The Edge Equine™ Dental Float, +2 Degree Head, 20-1/2" Length 5/8" Stainless Tubing, E-Series 40 mm (1-1/2") Blade	Each



The Edge Equine™ Dental Float, +2 Degree Head, 20-1/2" Length

Item	Product Description	UOM
53238	The Edge Equine™ Dental Float, +2 Degree Head, 20-1/2" Length 1/2" Stainless Tubing, E-Series 40 mm (1-1/2") Blade	Each



The Edge Equine™ Dental Float, +2 Degree Head, 20-1/2" Length

Item	Product Description	UOM
53237	The Edge Equine™ Dental Float, +2 Degree Head, 20-1/2" Length 5/8" Stainless Tubing, E-Series 50 mm (2") Blade	Each



The Edge Equine™ Dental Float, +2 Degree Head, 20-1/2" Length

Item	Product Description	UOM
53239	The Edge Equine™ Dental Float, +2 Degree Head, 20-1/2" Length 1/2" Stainless Tubing, E-Series 50 mm (2") Blade	Each



The Edge Equine™ Dental Float, +2 Degree Head, 20-1/2" Length

Item	Product Description	UOM
53220	The Edge Equine™ Dental Float, +2 Degree Head, 20-1/2" Length 3/8" Stainless Rod, S-Series 50 mm (2") Blade	Each





The Edge Equine™ Molar Roller Floats

The Edge Equine™ Dental Float, -6 Degree Head, 14-1/2" Length

Item	Product Description	UOM
53233	The Edge Equine™ Dental Float, -6 Degree Head, 14-1/2" Length 3/8" Stainless Rod, Angled, E-Series 40 mm (1-1/2") Blade	Each



The Edge Equine™ Dental Float, -6 Degree Head, 16" Length

Item	Product Description	UOM
53234	The Edge Equine™ Dental Float, -6 Degree Head, 16" Length 3/8" Stainless Rod, Straight, E-Series 50 mm (2") Blade	Each



The Edge Equine™ Floats - Miscellaneous



The Edge Equine™ Dental Float, +2 Degree Head, 21" Length

- Pistol grip trigger handle

Item	Product Description	UOM
53224	The Edge Equine™ Dental Float, +2 Degree Head, 21" Length 3/8" Stainless Rod, Trigger Handle, Straight, S-Series 50 mm (2") Blade	Each



The Edge Equine™ Dental Float, +6 Degree Head, 20-1/2" Length

Item	Product Description	UOM
53221	The Edge Equine™ Dental Float, +6 Degree Head, 20-1/2" Length 3/8" Stainless Rod, S-Series 40 mm (1-1/2") Blade	Each



The Edge Equine™ Dental Float, +2 Degree Head, 21" Length

- Pistol grip trigger handle

Item	Product Description	UOM
53225	The Edge Equine™ Dental Float, +2 Degree Head, 21" Length 3/8" Stainless Rod, Trigger Handle, S-Series 40 mm (2") Blade	Each



The Edge Equine™ Dental Float, -18 Degree Head, 16" Length

- For No. 1, No. 2 and No. 3 upper and No. 1 lower premolars
- 3/8" Stainless Rod, S-Series 50 mm (2") Blade

Item	Product Description	UOM
58225	The Edge Equine™ Dental Float, -18 Degree Head, 16" Length 3/8" Stainless Rod, S-Series 50 mm (2") Blade	Each



Standard Dental Floats - "L" Series Compatible

- Uses the "L" series blades
- American-made and crafted in polished extra-strong #7 gauge stainless steel
- Comfortable rasp handle enables the blade to cut on forward strokes for optimum floating efficiency
- Large 3/8" Allen-head set screws
- Flat shaft helps indicate relative angle on the dental arcade
- Blades sold separately

Item	Product Description	UOM
53258	Standard Dental Float, -10 Degree Head, 15" Total Length, 3" Blade	Each
53257	Standard Dental Float, -15 Degree Head, 19" Total Length, 3" Blade	Each
53256	Standard Dental Float, Offset, 19" Total Length, 3" Blade	Each
53255	Standard Dental Float, Offset, 21.5" Total Length, 3" Blade	Each
53309	Standard Dental Float, -5 Degree Head, 19" Total Length, 3" Blade	Each
53308	Standard Dental Float, Straight, 21" Total Length, 3" Blade	Each
53254	Standard Dental Float, Straight, 15" Total Length, 3" Blade	Each



53257



53255

Standard Dental Float - "E" Series Compatible

- Uses the "E" series blades

Item	Product Description	UOM
53260	Standard Dental Float, -30 Degree Head, 13.5" Total Length, 2" Blade	Each



"MS" Hand Floats

- Crafted in Australia of high quality stainless steel
- Uses an Australian standard 3-1/4" or 2" size blade
- One-piece heavy duty, solid stainless steel shaft and head construction creates a sturdy, durable float
- Flat handle shaft to help the user guide the blade along the teeth
- Large stainless steel handle with rubberized bands for durability and comfort
- Round flat head minimizes discomfort to the horse
- Blade is secured to the float by two screws
- Can be used with E or L Series Blades, sold separately



Item	Product Description	UOM
53201	"MS" Hand Float #1, Pistol Grip, 16" Length, 3-1/4" Blade	Each
53202	"MS" Hand Float #2, Straight, 15" Length, 2" Blade	Each
53203	"MS" Hand Float #3, Straight, 15" Length, 3-1/4" Blade	Each
53204	"MS" Hand Float #4, Back Angle, 11" Length, 3-1/4" Blade	Each
53205	"MS" Hand Float #5, Back Angle, 11" Length, 2" Blade	Each
53207	"MS" Hand Float #7, Straight Short, 11" Length, 3-1/4" Blade	Each





Disposable Float Blades

- Avoids the two-way mailing of regrinds and associated costs and time delays
- Minimizes the number of blades in your business (no more doubling-up of blades on hand and those away at the regrinders)
- Eliminates inconsistencies in the quality of your regrinds
- Removes the weight of excess carbide required for future regrinds

The Edge Equine™ E-Series Blades

Item	Product Description	UOM
53242	The Edge Equine™ E-Series Disposable 40 mm (1-1/2") Blade, Fine (Yellow)	2/Pack
53244	The Edge Equine™ E-Series Disposable 40 mm (1-1/2") Blade, Medium (Green)	2/Pack
53246	The Edge Equine™ E-Series Disposable 40 mm (1-1/2") Blade, Coarse (Red)	2/Pack
53248	The Edge Equine™ E-Series Disposable 40 mm (1-1/2") Blade, Fast (Blue)	2/Pack
53243	The Edge Equine™ E-Series Disposable 50 mm (2") Blade, Fine (Yellow)	2/Pack
53245	The Edge Equine™ E-Series Disposable 50 mm (2") Blade, Medium (Green)	2/Pack
53247	The Edge Equine™ E-Series Disposable 50 mm (2") Blade, Coarse (Red)	2/Pack
53249	The Edge Equine™ E-Series Disposable 50 mm (2") Blade, Fast (Blue)	2/Pack



The Edge Equine™ S-Series Blades

Item	Product Description	UOM
53008	The Edge Equine™ S-Series Disposable 40 mm (1-1/2") Blade, Fine (Yellow)	2/Pack
53009	The Edge Equine™ S-Series Disposable 40 mm (1-1/2") Blade, Medium (Green)	2/Pack
53010	The Edge Equine™ S-Series Disposable 40 mm (1-1/2") Blade, Coarse (Red)	2/Pack
53011	The Edge Equine™ S-Series Disposable 40 mm (1-1/2") Blade, Fast (Blue)	2/Pack
58200	The Edge Equine™ S-Series Disposable 40 mm (1-1/2") Blade, Super Fine (White)	2/Pack
53226	The Edge Equine™ S-Series Disposable 50 mm (2") Blade, Fine (Yellow)	2/Pack
53227	The Edge Equine™ S-Series Disposable 50 mm (2") Blade, Medium (Green)	2/Pack
53228	The Edge Equine™ S-Series Disposable 50 mm (2") Blade, Coarse (Red)	2/Pack
53252	The Edge Equine™ S-Series Disposable 50 mm (2") Blade, Fast (Blue)	2/Pack
58220	The Edge Equine™ S-Series Disposable 50 mm (2") Blade, Super Fine (White)	2/Pack



The Edge Equine™ L-Series Blades

Item	Product Description	UOM
53211	The Edge Equine™ L-Series Disposable 3-1/4" Blade, Fine (Yellow)	Each
53213	The Edge Equine™ L-Series Disposable 3-1/4" Blade, Medium (Green)	Each
53215	The Edge Equine™ L-Series Disposable 3-1/4" Blade, Coarse (Red)	Each
53217	The Edge Equine™ L-Series Disposable 3-1/4" Blade, Fast (Blue)	Each



Diamond "S" File

The Small Diamond "S" File measures 3/4" wide by 6" length. The cutting surface is coated with diamond chips and is used for final finishing.

Item	Product Description	UOM
53323	Small "S" File, 3/4" Wide x 6" Length, Fine, Diamond Chip	Each



OralEQ™ Equine Dental Rinse

A non-irritating, convenient oral rinse for equine dental health. By using OralEQ™ and following the specific directions, the horse's oral cavity will improve to a more consistent and healthy appearance.

- Improves oral hygiene
- Easy to use
- Palatable flavor
- Economical compared to competitors

Item	Product Description	UOM
53770	OralEQ™ Equine Dental Rinse - 1 Gallon	Each



Equine Skull Model & Teeth Set **PATENTED**

- Ideal for staff and client education
- Removable and replaceable teeth that depict many forms of dental malocclusion and other dental abnormalities
- Molded life size skull includes teeth which are functionally similar to equine teeth

Item	Product Description	UOM
53900	Equine Skull Model & Teeth Set	Each
53901	Replacement Teeth Set for Equine Skull Model	Each



Equine Dental Chart

Item	Product Description	UOM
53800	Equine Dental Chart	50/Pack



General Dental Invoice / Chart

Item	Product Description	UOM
53801	General Dental Invoice / Chart	50/Pack



The EEZY-MaXX™ Reciprocating Float Kit is a reliable reciprocating float system with a minimal 1/2" stroke length. The low profile allows the user complete maneuverability around the dental arcade. The system is ideal for removing caudal hooks and finishing upper and lower molars. The reciprocating float shafts pair with The Edge Equine™ 40 mm (1-1/2") Disposable Blade, radius ends. The De-MaX™ III reciprocating float shafts are also compatible with the EEZY-MaXX™ Reciprocating Float Kit.

KIT INCLUDES:

- EEZY-MaXX™ Reciprocating Float System
- M12 Battery Charger
- M12 Battery (1.5Ah) (2)
- Reciprocating Straight Float Shaft, 19" Working Length
- Reciprocating Angled Float Shaft, 19" Working Length
- M12 Shaft Adaptor (2)
- T-Handle Hex Key 2.5 mm
- T-Handle Hex Key 3/32"
- Weatherproof Carrying Case



ACCESSORIES:



See **page 69**
for more information!

Item	Product Description	UOM
53120	EEZY-MaXX™ Reciprocating Float Kit	Each
Accessories		
53119	EEZY-MaXX™ Reciprocating Float ONLY	Each
53123	M12 Battery Charger	Each
53124	M12 Battery (1.5Ah)	Each
53003	Reciprocating Straight Shaft Float, 19" Working Length	Each
53003S	Reciprocating Straight Shaft Float, 13" Working Length	Each
53004	Reciprocating Angled Shaft Float, 19" Working Length	Each
53004S	Reciprocating Angled Shaft Float, 13" Working Length	Each
53121	M12 Shaft Adaptor Kit	Each
53122	M12 Shaft Adaptor Set Screw Kit	5/Pack
53006	Float Blade Set Screw Kit	5/Pack

**QUALITY
AND
AFFORDABILITY**

BoneWelder® Vet System

The BoneWelder® Vet System employs ultrasonic technology and resorbable implants to revolutionize osteosynthesis procedures. Two different technologies were developed using this ultrasonic bone welding process: The VetWelding® Weldix® Micro-Suture Anchor and The Resorb Pin and Plate System. Both processes combine ultrasonic technology and resorbable implants to provide stable fixation of bones and eliminate the need for secondary operations. Additionally, thermal impact on the bone is minimal, localized to the polymer instrument, to prevent additional trauma to the bone or osseointegration. The BoneWelder® Vet System includes the BoneWelder® Vet Ultrasonic Device, BoneWelder® Vet Handpiece and BoneWelder® Vet Wrench.



48561

Ultrasonic Thermal Technology

The thermal impact on the bone is minimal. The short ultrasonic impulse (1 second) and the localized melting of the polymer disturbs neither bone healing nor osseointegration.

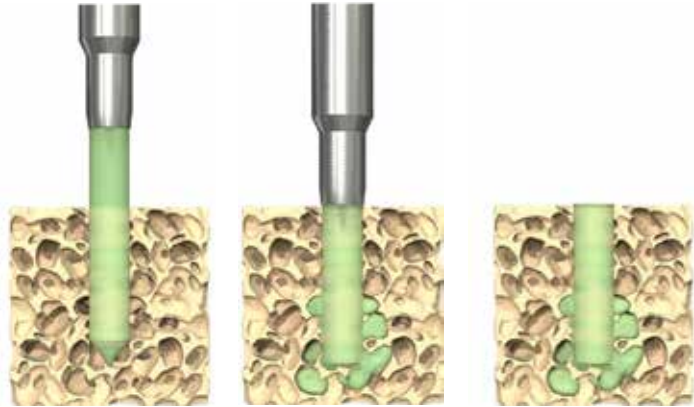

BoneWelder® Vet Ultrasonic Device

The BoneWelder® Vet Ultrasonic Device is a small, user-friendly machine that generates and provides the energy to power the ultrasonic handpiece. The machine offers two handpiece plug-in options for dual user capabilities. This device is used for all BoneWelder® implants.



The handpiece for the BoneWelder® Vet is lightweight and ergonomically designed for comfort in handling. One button technology allows for ease of use for transferring the ultrasonic power to the implant.



The wrench allows users to mount the sonotrode properly on the handpiece making sure the connection is tight for an appropriate transfer of the ultrasonic energy into the implant. Fits on every sonotrode.



Item	Product Description	UOM
47010	BoneWelder® Vet System (includes Ultrasonic Device, Handpiece, Power Cord & Wrench)	Each
47012	BoneWelder® Vet Ultrasonic Device	Each
47015	BoneWelder® Vet Handpiece	Each
47018	BoneWelder® Vet Wrench	Each



Weldix® 2.3 mm Anchor

The Weldix® 2.3 mm Anchor is a revolutionary ultrasonic micro-suture anchor that provides bone anchorage even in the absence of cortical bone. The Weldix® Anchor is combined with the BoneWelder® Vet Ultrasonic Device, a sonotrode and a drill as part of the bone anchoring procedure. The biocompatible, bioresorbable anchor is made with polylactide and designed with two transversal apical “click-in” grooves for positioning suture prior to implantation in the bone. It can be used in a variety of procedures in cats and dogs, including hip luxation, tarsal collateral ligament repair, achilles tendon repair, CCL extracapsular repair, knee collateral ligament repair and elbow / shoulder luxation repair. The Weldix® 2.3 mm Anchor is designed with two grooves, one for USP #4-0 and #3-0 and one for USP #2-0 to #2. Suture is not included.

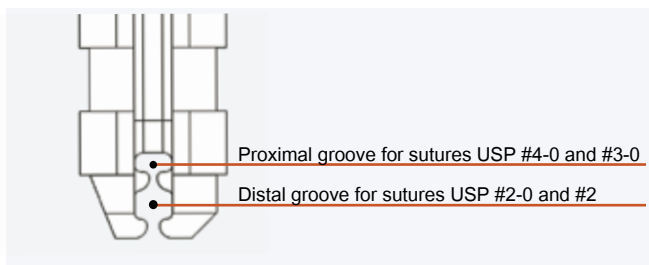

Weldix® 2.3 mm Anchor Instruments

In order to use the Weldix® Anchor technology, pair the BoneWelder® Vet System (Item #47010) with the following instruments:

BoneWelder® Vet Conical 2 mm Sonotrode

The BoneWelder® Vet Conical 2 mm Sonotrode is a handpiece tip which is mounted on the BoneWelder® Vet Handpiece and transmits the ultrasonic energy to the Weldix® Anchor. The sonotrode has a press fit with the Weldix® Anchor to prevent it from falling off.



The twist drill (available with or without stop) is used to safely and easily drill an entry hole for implantation of the Weldix® Anchor into the bone.

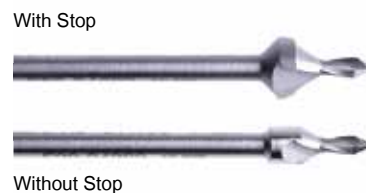

Item	Product Description	UOM
47050	Weldix® 2.3 mm Anchor	Each
47060	BoneWelder® Vet Conical 2 mm Sonotrode	Each
47063	Drill Bit for Weldix® 2.3 mm Anchor with Drill Stop	Each
47065	Drill Bit for Weldix® 2.3 mm Anchor without Drill Stop	Each



VetWelding® Resorb Pin and Plate System

The Resorb Pin and Plate System combines highly advanced ultrasound technology with resorbable implants to provide extremely stable fixation and often eliminate the need for a second operation. Resorb pins can achieve twice the strength of standard resorbable screws. Resorb Pin and Plate System technology eliminates the need for pre-tapping and significantly reduces implantation and surgical time. The Resorb Pin and Plate System is intended for surgical procedures in which an internal fixation by resorbable implants is required for aligning, reconstructing and stabilizing bone tissue. It is indicated for use in non-load-bearing applications. Some possible applications include treatment of maxillofacial fractures, laminoplasty, reconstruction of bone defects after cranial tumor resection, wound closure following equine tooth extraction and closure of hard palate defect.

Implantation consists of a simple 3-step procedure:

1. Resorbable plates or meshes are warmed in a water bath and shaped to fit the application site
2. Holes are pre-drilled for the pins
3. Plates are fixed into place with Resorb Pins
 - Sonotrode liquefies the pins
 - Pins bond with the plate or mesh
 - Polymer penetrates the bone cavities and anchors implant securely

Resorb System Instruments

The Resorb Pin and Plate System consists of the following instruments which aid in the implementation process:

Sonotrodes

The standard sonotrode is a tip which is mounted onto the BoneWelder® Vet Handpiece and transmits the ultrasonic energy to insert the pins. It is available in straight or angled positions.

The smoothing sonotrode is a tip which is mounted onto the BoneWelder® Vet Handpiece and transmits the ultrasonic energy to smooth the implants. It is available in straight or angled positions.

Item	Product Description	UOM
47400	BoneWelder® Vet Standard Sonotrode, Straight	Each
47402	BoneWelder® Vet Standard Sonotrode, Angled	Each
47410	BoneWelder® Vet Smoothing Sonotrode, Straight	Each
47412	BoneWelder® Vet Smoothing Sonotrode, Angled	Each

Drill Bits

Two sizes of drill bits are available. The 1.0 mm drill bit is sized specifically for 1.6 mm pins and is available in three lengths. The 1.6 mm drill bit is sized specifically for 2.1 mm pins and is also offered in three lengths.

Item	Product Description	UOM
47430	Drill Bit 1.0 mm x 40 x 3 mm (for 1.6 mm Resorb Pins)	Each
47432	Drill Bit 1.0 mm x 40 x 4 mm (for 1.6 mm Resorb Pins)	Each
47434	Drill Bit 1.0 mm x 40 x 5 mm (for 1.6 mm Resorb Pins)	Each
47440	Drill Bit 1.6 mm x 40 x 4 mm (for 2.1 mm Resorb Pins)	Each
47442	Drill Bit 1.6 mm x 40 x 5 mm (for 2.1 mm Resorb Pins)	Each
47444	Drill Bit 1.6 mm x 40 x 10 mm (for 2.1 mm Resorb Pins)	Each

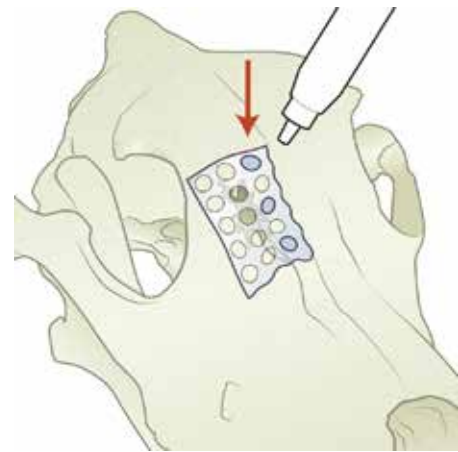

Standard Sonotrode, Straight



Standard Sonotrode, Angled

Smoothing Sonotrode, Straight



Smoothing Sonotrode, Angled



1 mm Drill Bit



1.6 mm Drill Bit



Resorb System Instruments

BOS-Drill

The ergonomically designed BOS Drill can be used to create the pilot holes for the Resorb Pin and Plate System. The BOS Drill rotates at 600 RPM and is autoclavable. Battery Pack can be purchased separately.

Item	Product Description	UOM
47422	BOS-Drill Handpiece	Each
47420	BOS-Battery Pack, Sterile	Each



Template Mesh

The template mesh helps with determining positioning of Resorb plates and pins prior to implantation.

Item	Product Description	UOM
47450	Template Mesh, 25 x 25 mm	Each
47460	Template Mesh, 50 x 50 mm	Each

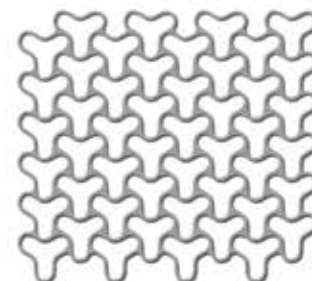

Water Bath

The specialized water bath can be used to warm the resorbable plates just prior to use. After only a few seconds, the implant can then be shaped, contoured and cut to adapt to the surface of the bone. The water bath cover and insert (water container) can be purchased separately for use during multiple procedures and are autoclavable.

Item	Product Description	UOM
47480	Water Bath Complete (includes Bath, Cover, Insert & Power Cord)	Each
47481	Water Bath Cover	Each
47482	Water Bath Insert (Water Container)	Each



Resorb Pins

The Resorb Pins affix the Resorb Plates or Meshes into place and fuse with the bone when liquefied by the ultrasonic energy. Resorb Pins are biocompatible and bioresorbable, made with polylactide.

Item	Product Description	UOM
47100	Resorb Pin 1.6 mm Diameter, 4 mm Length	5/Pack
47102	Resorb Pin 1.6 mm Diameter, 5 mm Length	5/Pack
47125	Resorb Pin 2.1 mm Diameter, 4 mm Length	5/Pack
47127	Resorb Pin 2.1 mm Diameter, 5 mm Length	5/Pack
47129	Resorb Pin 2.1 mm Diameter, 7 mm Length	5/Pack
47132	Resorb Pin 2.1 mm Diameter, 9 mm Length	5/Pack



1.6 mm

2.1 mm



Resorb Plates & Meshes

The Resorb Plates & Meshes are available in a variety of different shapes, sizes and thicknesses. They are easy to cut with scissors and contoured intraoperatively. Plates are simply warmed in a sterile water bath for 10 seconds and can then be shaped to fit the application site. Resorb Plates & Meshes are biocompatible and bioresorbable, made with polylactide.

Item	Product Description	UOM
47250	Resorb Plate Straight, 4 Holes, 1 mm	Each
47252	Resorb Y-Plate, 5 Holes, 1 mm	Each
47254	Resorb L-Plate, 6 Holes, 1 mm	Each
47256	Resorb Reverse L-Plate, 6 Holes, 1 mm	Each
47258	Resorb Plate Straight, 22 Holes, 1 mm	Each
47270	Resorb Mesh Plate 1 mm, 26 x 26 mm	Each
47275	Resorb Mesh Plate 1 mm, 51 x 51 mm	Each
47280	Resorb Mesh Plate 1 mm, 126 x 126 mm	Each
47285	Resorb Mesh Plate 1mm, 31 x 106 mm	Each
47290	Resorb Orbital Floor Plate 23 mm W, 0.6 mm Thickness	Each
47300	Resorb Sheet 0.6 mm, 51 x 51 mm	Each
47325	Resorb Plate 1 mm, 11 x 126 mm	Each

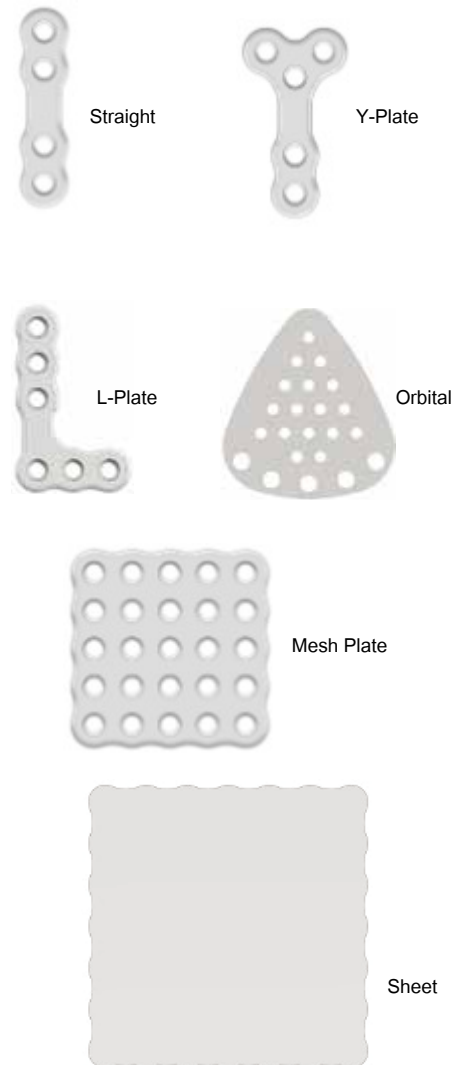

Resorb Plus+ Plates

The Resorb Plus+ Plates are made with 85% Poly-L-lactide and 15% Poly-glycolic acid. Resorb Plus+ Plates are a strengthened version of the standard Resorb Plates.

Item	Product Description	UOM
47200	Resorb Plus+ Plate Straight, 4 Holes, 1 mm	Each
47205	Resorb Plus+ Plate Straight, 22 Holes, 1 mm	Each



VetWelding® Oral Maxillofacial and Orthopedic Sets

Item	Product Description	UOM
47500	VetWelding® OMF Instrument Set	Each
Kit includes:		
47010	BoneWelder® Vet System (includes Ultrasonic Device, Handpiece, Power Cord & Wrench)	Each
47060	BoneWelder® Vet Conical 2 mm Sonotrode	Each
47400	BoneWelder® Vet Standard Sonotrode, Straight	Each
47410	BoneWelder® Vet Smoothing Sonotrode, Straight	Each
47063	Drill Bit for Weldix® 2.3 mm Anchor with Drill Stop	Each
47432	Drill Bit 1.0 mm x 40 x 4 mm (for 1.6 mm Resorb Pins)	Each
47434	Drill Bit 1.0 mm x 40 x 5 mm (for 1.6 mm Resorb Pins)	Each
47440	Drill Bit 1.6 mm x 40 x 4 mm (for 2.1 mm Resorb Pins)	Each
47442	Drill Bit 1.6 mm x 40 x 5 mm (for 2.1 mm Resorb Pins)	Each
47450	Template Mesh, 25 x 25 mm	Each
47460	Template Mesh, 50 x 50 mm	Each
47480	Water Bath Complete (includes Bath, Cover, Insert & Power Cord)	Each

Item	Product Description	UOM
47510	VetWelding® OMF Implant Set	Each
Kit includes:		
47100	Resorb Pin 1.6 mm Diameter, 4 mm Length	5/Pack
47102	Resorb Pin 1.6 mm Diameter, 5 mm Length	5/Pack
47125	Resorb Pin 2.1 mm Diameter, 4 mm Length	5/Pack
47127	Resorb Pin 2.1 mm Diameter, 5 mm Length	5/Pack
47129	Resorb Pin 2.1 mm Diameter, 7 mm Length	5/Pack
47250	Resorb Plate Straight, 4 Holes, 1 mm	Each
47252	Resorb Y-Plate, 5 Holes, 1 mm	Each
47258	Resorb Plate Straight, 22 Holes, 1 mm	Each
47290	Resorb Orbital Floor Plate 23 mm W, 0.6 mm Thickness	Each
47050	Weldix® 2.3 mm Anchor	Each
47270	Resorb Mesh Plate 1 mm, 26 x 26 mm	Each
47275	Resorb Mesh Plate 1 mm, 51 x 51 mm	Each

Item	Product Description	UOM
47515	VetWelding® Orthopedic Instrument Set	Each
47520	VetWelding® Orthopedic Implant Set	Each

VetWelding® Training and Education

In VetWelding® educational trainings, you will receive a combination of theoretical and hands-on applications, using either saw bone or cadaver bone to hone your skills. Working one-on-one with each team member is core to our philosophy of staff education. Training can be completed in your practice or in our offices in Switzerland. Following completion of this training, we are available for troubleshooting equipment or virtually in the operating room if you have questions regarding surgical procedures. Please call for more information regarding training.

VetWelding® AG and MAI Animal Health will not be liable for any damages of any kind, under any legal theory arising out of or in connection with any non-intended use of the BoneWelder® Vet System, the Weldix® Anchor System or the Resorb Pin and Plate System. Any off-label use shall be the sole responsibility of the performing surgeon, who will be held singularly liable for complications occurring thereof.



Suture Cross-Reference Chart

NON-ABSORBABLE		MATERIAL DESCRIPTION	QUALITIES		SIMILAR TO
NYLON		Black Monofilament	High strength retention		Ethilon™ * Monosof™ §/ Dermalon™ § Daiflon™ †
FLUOROMID™		Fluorescent Yellow Polyamide Multifilament	Easy handling, ultra high visibility Fluorescent Yellow		
SHORTY™ POLYVINYLIDENE FLUORIDE YELLOW		Bright Yellow Monofilament	High visibility Exceptional knot security, knots flatten and lock against themselves, unwetted by blood, inert		
BLUE POLYPROPYLENE		Dark Blue Monofilament	Unwetted by blood, inert, knots flatten and lock against themselves for improved knot security		Prolene™ * Surgipro™ §/ Surgilene™ § Premilene™ †
FLUORESCENT PINK POLYPROPYLENE		Fluorescent Pink Monofilament	Ultra high visibility Fluorescent Pink Unwetted by blood, inert, knots flatten and lock against themselves for improved knot security		
POLYESTER		Braided Polyester Green Silicone Coated	High strength braid		Ticron§ Ethibond*
ABSORBABLE		MATERIAL DESCRIPTION	BSR PROFILE	MASS ABSORPTION	SIMILAR TO
GLYCOLIDE & ECAP		Monofilament Purple	In vivo strength retention 60% at 7 days 25% at 14 days	Essentially complete between 2-4 months	Monocryl™ * Caprosyn™ §/ Biosyn™ § Monosyn™ †
POLYGLYCOLIC ACID		Braided Violet	In vivo strength retention 65% at 14 days 20% at 21 days	Essentially complete between 3-6 months	Vicryl™ * Safil™ † Polsorb§
POLYGLYCOLIC ACID FAST ABSORBING		Braided Undyed	In vivo strength retention 48% at 7 days 0% at 14 days	Essentially complete at 6 weeks	Vicryl Rapide* Safil Quick †
POLYGLACTIN		Braided Violet	In vivo strength retention 74% at 14 days 49% at 21 days 24% at 28 days	Essentially complete at 9 weeks	Vicryl™
POLYDIOXANONE		Monofilament Purple	In vivo strength retention 80-90% at 14 days 60-80% at 28 days 50-80% at 42 days	Essentially complete between 6-9 months	PDS11™ * MonoPlus™ † Maxon§

* Trademark of Ethicon § Trademark of Covidien † Trademark of B.Braun



Summary of Advantages of SilverGlide™ Sutures

	Current Sutures Used	SilverGlide™ Advantages
SKIN CLOSURE	Black Nylon	RR pink polypropylene, High color contrast
	Supramid® (threaded)	Fluoromid™ high color contrast, Super-sharp swaged needle
CASLICKS Non-absorbable	Black Nylon	RR pink polypropylene, High color contrast, Short length, 50 mm cutting needle
	Supramid® (threaded)	Fluoromid™ high color contrast, Super-sharp 50 mm swaged needle
CASLICKS Absorbable	Vicryl® (PGLA)	Low cost, Specialty short length sutures for small animal incisions and Caslicks
	PDS11	EC-CLK range: short suture, Low cost
LINEA ALBA CLOSURE	Vicryl® #3 on cutting needle	PGLA #3 on taper needle, PGA #3 on taper needle

Vicryl is a registered trademark of Ethicon.

Supramid is a registered trademark of S. Jackson Company.

NON-ABSORBABLE SUTURES



Polyvinylidene Fluoride, Bright Yellow Monofilament, Non-absorbable - 'Shorty'™ Sutures

Exceptional knot security, knots flatten and lock themselves, unwetted by blood, inert. Ultra high visibility and useful for small incisions.

Item	Needle Length	Needle Silhouette	Needle Type	USP Gauge	Suture Length	UOM
75514PVDF-1	25 mm		3/8 Circle Reverse Cutting	2-0	45 cm	36/Box
75514PVDF-2			3/8 Circle Reverse Cutting	3-0	45 cm	36/Box

Double forward throw
(Surgeons Throw)

Single reverse throw
Creating a square knot, with which to adjust tension.

Single forward throw
(Locking the knot)

Final result
9 interlocked sutures, with long tails, from a 45cm length.



Cinches down and knots securely in just three throws



Need Scissors?

See more Surgical Instruments on pages 111-116!



Item #54584 - Iris Scissors



Polypropylene Sutures, Fluro Pink Monofilament, Non-absorbable

Similar to Prolene®

Unwetted by blood, inert, knots flatten and lock against themselves for improved knot security.

Prolene is a registered trademark of Ethicon.

Item	Needle Length	Needle Silhouette	Needle Type	USP Gauge	Suture Length	UOM
75501RR-1	24 mm		3/8 Circle Reverse Cutting	3-0	45 cm	36/Box
75501RR-9			3/8 Circle Reverse Cutting	3-0	70 cm	36/Box
75501RR-10	30 mm		3/8 Circle Reverse Cutting	2-0	70 cm	36/Box
75501RR-2			3/8 Circle Reverse Cutting	2-0	45 cm	36/Box
75501RR-12	37 mm		1/2 Circle Reverse Cutting	0	100 cm	36/Box
75501RR-3	50 mm		3/8 Circle Reverse Cutting	0	45 cm	36/Box
75501RR-4			3/8 Circle Reverse Cutting	1	45 cm	36/Box
75501RR-23			3/8 Circle Reverse Cutting	2	45 cm	36/Box
75501RR-13			3/8 Circle Reverse Cutting	0	100 cm	36/Box
75501RR-14			3/8 Circle Reverse Cutting	1	100 cm	36/Box
75501RR-15			3/8 Circle Reverse Cutting	2	100 cm	36/Box
75501RR-11			60 mm		Straight Cutting	2-0

*Specialty short lengths for small closures and Caslicks.

*Best selling for skin closure.

Fluorimid™ / Fluomid™ Sutures*, Fluorescent Yellow, Multifilament Polyamide, Non-absorbable

- Easy handling, ultra high visibility

Item	Needle Length	Needle Silhouette	Needle Type	USP Gauge	Suture Length	UOM
75507SMF-8	24 mm		3/8 Circle Reverse Cutting	3-0	70 cm	36/Box
75507SMF-9	30 mm		3/8 Circle Reverse Cutting	2-0	70 cm	36/Box
75507SMF-10	37 mm		1/2 Circle Reverse Cutting	0	90 cm	36/Box
75507SMF-11	50 mm		3/8 Circle Reverse Cutting	1	100 cm	36/Box
75507SMF-12	65 mm		Straight Cutting	3	130 cm	12/Box
75507SMF-13	75 mm		Ski Cutting	3	130 cm	12/Box

*Brands sourced from different locations.



Nylon Sutures, Black Monofilament, Non-absorbable

Similar to Ethilon®

Ethilon is a registered trademark of Ethicon.

Item	Needle Length	Needle Silhouette	Needle Type	USP Gauge	Suture Length	UOM
75509N-10	30 mm		3/8 Circle Reverse Cutting	2-0	70 cm	36/Box
75509N-11			3/8 Circle Reverse Cutting	0	100 cm	36/Box
75509N-12	50 mm		3/8 Circle Reverse Cutting	1	100 cm	36/Box

Braided Polyester Sutures

Item	Needle Length	Needle Silhouette	Needle Type	USP Gauge	Suture Length	UOM
75511BP-1	37 mm		1/2 Circle Reverse Cutting	5	70 cm	36/Box

ABSORBABLE SUTURES

Glycolide Sutures, Purple Monofilament, Absorbable

- 60% retained tensile strength at 7 days
- Essentially complete between 2-4 months

Similar to Monocryl®

Monocryl is a registered trademark of Ethicon.

This material is contraindicated for Bovine Muscle Closure.

Item	Needle Length	Needle Silhouette	Needle Type	USP Gauge	Suture Length	UOM
75505EC-17	11 mm		1/2 Circle Taper Point	5-0	45 cm	12/Box
75505EC-12	16 mm		1/2 Circle Taper Point	4-0	45 cm	12/Box
75505EC-23			3/8 Circle Reverse Cutting	5-0	45 cm	12/Box
75505EC-22	18 mm		1/2 Circle Taper Point	4-0	70 cm	36/Box
75505EC-24			1/2 Circle Taper Point	5-0	45 cm	12/Box
75505EC-20	22 mm		1/2 Circle Taper Point	3-0	70 cm	36/Box
75505EC-25			1/2 Circle Taper Point	4-0	70 cm	36/Box
75505EC-21	24 mm		3/8 Circle Reverse Cutting	3-0	70 cm	36/Box
75505EC-18	26 mm		3/8 Circle Reverse Cutting	2-0	70 cm	36/Box
75505EC-26	26.5 mm		1/2 Circle Taper Point	3-0	70 cm	36/Box
75505EC-27			1/2 Circle Taper Point	2-0	70 cm	36/Box



Glycolide Sutures, Purple Monofilament, Absorbable

- 60% retained tensile strength at 7 days
- Essentially complete between 2-4 months

Similar to Monocryl®

Monocryl is a registered trademark of Ethicon.
This material is contraindicated for Bovine Muscle Closure.

Item	Needle Length	Needle Silhouette	Needle Type	USP Gauge	Suture Length	UOM
75505EC-1	30 mm		3/8 Circle Reverse Cutting	2-0	45 cm	36/Box
75505EC-7	37 mm		1/2 Circle Reverse Cutting	2-0	70 cm	36/Box
75505EC-2	50 mm		3/8 Circle Reverse Cutting	0	45 cm	36/Box
75505EC-10	65 mm		1/2 Circle Taper Point	1	130 cm	12/Box

*Specialty short lengths for small closures and Caslicks.

Chromic Catgut Sutures, Natural Absorbable

- 100% retained tensile strength at 7 days
- Essentially complete in 3 months

Item	Needle Length	Needle Silhouette	Needle Type	USP Gauge	Suture Length	UOM
75515CG-1	65 mm		1/2 Circle Taper Point	1	130 cm	12/Box
75515CG-2			1/2 Circle Taper Point	2	130 cm	12/Box

Polyglactin Sutures

Item	Needle Length	Needle Silhouette	Needle Type	USP Gauge	Suture Length	UOM
75503PGLA-1	65 mm		1/2 Circle Taper Point	3	90 cm	36/Box
75504PGLA-1	65 mm		1/2 Circle Taper Point	3	90 cm	12/Box



Polyglycolic Acid Fast Absorbing Sutures

- 48% retained tensile strength at 7 days
- Essentially complete at 14 days

Item	Needle Length	Needle Silhouette	Needle Type	USP Gauge	Suture Length	UOM
75503PG-34	12 mm		3/8 Circle Reverse Cutting	6-0	45 cm	36/Box
75503PG-38	13 mm		1/2 Circle Reverse Cutting	5-0	45 cm	36/Box
75503PG-7	16 mm		3/8 Circle Reverse Cutting	4-0	45 cm	36/Box

Polyglycolic Acid Sutures, Braided Violet, Absorbable

- 65% retained tensile strength at 14 days
- Essentially complete between 2-4 months

Similar to Vicryl®

Vicryl is a registered trademark of Ethicon.

Item	Needle Length	Needle Silhouette	Needle Type	USP Gauge	Suture Length	UOM
75503PG-28	12 mm		3/8 Circle Reverse Cutting	5-0	45 cm	12/Box
75503PG-27	18 mm		3/8 Circle Reverse Cutting	4-0	70 cm	36/Box
75503PG-32	22 mm		1/2 Circle Taper Point	3-0	70 cm	36/Box
75503PG-33			1/2 Circle Taper Point	4-0	70 cm	36/Box
75503PG-1	24 mm		3/8 Circle Reverse Cutting	3-0	45 cm	36/Box
75503PG-26			3/8 Circle Reverse Cutting	3-0	70 cm	36/Box
75503PG-23	26 mm		1/2 Circle Reverse Cutting	2-0	70 cm	36/Box
75503PG-10	26.5 mm		1/2 Circle Taper Point	0	70 cm	36/Box
75503PG-24			1/2 Circle Taper Point	2-0	70 cm	36/Box
75503PG-25			1/2 Circle Taper Point	3-0	70 cm	36/Box
75503PG-2	30 mm		3/8 Circle Reverse Cutting	2-0	45 cm	36/Box
75503PG-35			3/8 Circle Reverse Cutting	0	45 cm	36/Box
75503PG-17	40 mm		1/2 Circle Taper Point	0	100 cm	36/Box
75503PG-18			1/2 Circle Taper Point	1	100 cm	36/Box
75503PG-3	50 mm		3/8 Circle Reverse Cutting	0	45 cm	36/Box
75503PG-4			3/8 Circle Reverse Cutting	1	45 cm	36/Box
75503PG-36			3/8 Circle Reverse Cutting	2	45 cm	36/Box



Polyglycolic Acid Sutures, Braided Violet, Absorbable

- 65% retained tensile strength at 14 days
- Essentially complete between 2-4 months

Similar to Vicryl®

Vicryl is a registered trademark of Ethicon.

Item	Needle Length	Needle Silhouette	Needle Type	USP Gauge	Suture Length	UOM
75503PG-16	65 mm		1/2 Circle Taper Point	3	100 cm	12/Box
75503PG-20			1/2 Circle Taper Point	1	130 cm	36/Box
75503PG-21			1/2 Circle Taper Point	2	130 cm	36/Box
75503PG-22			1/2 Circle Taper Point	3	130 cm	12/Box
75503PG-31	90 mm		3/8 Circle Taper Point	3	130 cm	12/Box

Polydioxanone Sutures, Purple Monofilament, Absorbable

- 50-80% retained tensile strength at 42 days
- Essentially complete between 6-9 months

Similar to PDS®

PDS is a registered trademark of Ethicon.

Item	Needle Length	Needle Silhouette	Needle Type	USP Gauge	Suture Length	UOM
75513PO-15	22 mm		1/2 Circle Taper Point	4-0	70 cm	36/Box
75513PO-13	24 mm		3/8 Circle Reverse Cutting	3-0	70 cm	36/Box
75513PO-14	26 mm		3/8 Circle Reverse Cutting	2-0	70 cm	36/Box
75513PO-4	26.5 mm		1/2 Circle Taper Point	2-0	70 cm	36/Box
75513PO-12			1/2 Circle Taper Point	3-0	70 cm	36/Box
75513PO-5	36 mm		1/2 Circle Taper Point	2-0	70 cm	36/Box
75513PO-9			1/2 Circle Taper Point	1	100 cm	36/Box
75513PO-1	40 mm		1/2 Circle Reverse Cutting	0	100 cm	36/Box
75513PO-2			1/2 Circle Reverse Cutting	1	100 cm	36/Box
75513PO-3			1/2 Circle Reverse Cutting	2	100 cm	36/Box
75513PO-8			1/2 Circle Taper Point	0	100 cm	36/Box
75513PO-20	50 mm		3/8 Circle Reverse Cutting	2	100 cm	36/Box
75513PO-23			3/8 Circle Reverse Cutting	0	45 cm	36/Box
75513PO-28			3/8 Circle Reverse Cutting	0	100 cm	36/Box
75513PO-11	65 mm		1/2 Circle Taper Point	2	130 cm	12/Box
75513PO-19			1/2 Circle Taper Point	1	130 cm	12/Box



NEEDLE CHARTS - CIRCLE TAPER POINT & STRAIGHT CUTTING



1/2 Circle Taper Point

Needle	Size	SilverGlide™	Ethicon™ (similar)	Syneture™	B. Braun™ (similar)
	⊙ 11 mm	T11	-		
	⊙ 13 mm	T22	TF	CV-22	HR13
	⊙ 16 mm	T16	-		
	⊙ 18 mm	T28	RB-1	CV-23	HR18
	⊙ 22 mm	T4	SH-1	CV-25	HR22
	⊙ 26.5 mm	T5	SH / CT-1	V20 / GS22	HR26
	⊙ 36 mm	T8	MH / V-26	V-26	HR36
	⊙ 37 mm	T37	CT-1	-	-
	⊙ 40 mm	T40	-	-	-
	⊙ 65 mm	T39	TP-1	-	-

3/8 Circle Taper Point

Needle	Size	SilverGlide™	Ethicon™ (similar)	Syneture™	B. Braun™ (similar)
	⊙ 90 mm	T90	-	-	-

Straight Cutting

Needle	Size	SilverGlide™	Ethicon™ (similar)	Syneture™	B. Braun™ (similar)
Straight Cutting	▽ 60 mm	CE60	KS	SC-2	GS60
Straight Cutting	▽ 65 mm	CE65	KS	SC-2	GS60
1/2 Circle Conventional Cutting / Straight Shank (Ski) △	△ 75 mm	SKI75	-	-	-

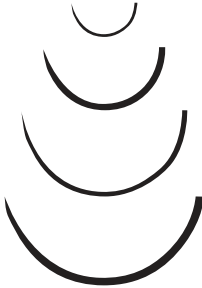

1/2 Circle Reverse Cutting ▽

Needle	Size	SilverGlide™	Ethicon™ (similar)	Syneture™	B. Braun™ (similar)
	▽ 13 mm	C13	-	-	-
	▽ 26 mm	C21	CP-2	GS-10	HS26
	▽ 37 mm	C37	CP-1	GS-11	HS37
	▽ 40 mm	C14	CP	GS-12	HS40

3/8 Circle Reverse Cutting ▽

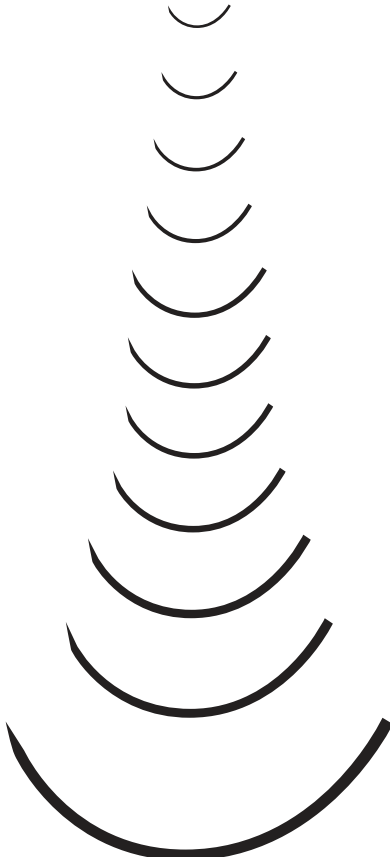
Needle	Size	SilverGlide™	Ethicon™ (similar)	Syneture™	B. Braun™ (similar)
	▽ 11 mm	C16	C-2	C-1	DS12
	▽ 12 mm	C17	C-2	C-1	DS12
	▽ 16 mm	C22	FS-3	C-12	DS16
	▽ 18 mm	C6	FS-2	C-13	DS18
	▽ 24 mm	C7	FS-1	C-14	DS24
	▽ 25 mm	C25	-	-	-
	▽ 26 mm	C26	FS	-	-
	▽ 30 mm	C10	FSL	C-16	DS30
	▽ 40 mm	C14	FSLX	C-17	-
	▽ 50 mm	C50	-	-	-
	▽ 77 mm	C77	LR	-	-

Note:
 45 cm – approximately 18”
 90 cm – approximately 36”
 100 cm – approximately 40”
 130 cm – approximately 51”



Meet our newest arrival...SHORTY™!

Ultra High Visibility, Easy Handling, Non-absorbable

- Polyvinylidene Fluoride Monofilament
- Bright Yellow High Visibility
- Very low memory
- Superior knot security
- 45 cm / 18"



<p>Double forward throw (Surgeons Throw)</p>	<p>Single reverse throw Creating a square knot, with which to adjust tension.</p>	<p>Single forward throw (Locking the knot)</p>	<p>Final result 9 interrupted sutures, with long tails, from a 45cm length.</p>
---	--	---	--

Cinches down and knots securely in just three throws

See details on page 102!

Hemostats

German Mosquito Hemostat Straight, 5"



German Mosquito Hemostat can be used in various veterinary surgical and ophthalmologic procedures. This instrument features fine tips, short and fully serrated jaws.

Item	Product Description	UOM
75302SG	German Mosquito Hemostat Straight, 5" Length	Each



German Mosquito Hemostat Curved, 5"



The German Mosquito Hemostat can be used in various veterinary surgical and ophthalmologic procedures. This instrument features fine tips, short and fully serrated jaws.

Item	Product Description	UOM
75302CG	German Mosquito Hemostat Curved, 5" Length	Each



German Kelly Hemostat Straight, 5.5"



The German Kelly Hemostat is primarily used for clamping large blood vessels or manipulating heavy tissue by the veterinarian. The instrument may also be used for soft tissue dissection. This instrument is available with a ratcheted finger ring handle. The tips of German Kelly Hemostat are serrated halfway up the jaws.

Item	Product Description	UOM
75306SG	German Kelly Hemostat Straight, 5.5" Length	Each



German Kelly Hemostat Curved, 5.5"



The German Kelly Hemostat is primarily used for clamping large blood vessels or manipulating heavy tissue by the veterinarian. The instrument may also be used for soft tissue dissection. It is available with a ratcheted finger ring handle. The tips of German Kelly Hemostat are serrated halfway up the jaws.

Item	Product Description	UOM
75306CG	German Kelly Hemostat Curved, 5.5" Length	Each



Kelly Hemostat Forceps Straight, 6.25"



Kelly Hemostat forceps are primarily used for clamping large blood vessels or manipulating heavy tissue by the veterinarian. They may also be used for soft tissue dissection and various miscellaneous tasks. They are available with a ratcheted finger ring handle. The jaws of Kelly Forceps are 1/3 the length of the shanks and serrations are 1/2 the length of the jaws.

Item	Product Description	UOM
75308SG	Kelly Hemostat Forceps Straight, 6.25" Length	Each



Kelly Hemostat Forceps Curved, 6.25"



Kelly Hemostat forceps are primarily used for clamping large blood vessels or manipulating heavy tissue by the veterinarian. They may also be used for soft tissue dissection and various miscellaneous tasks. They are available with a ratcheted finger ring handle. The jaws of Kelly Forceps are 1/3 the length of the shanks and serrations are 1/2 the length of the jaws.

Item	Product Description	UOM
75308CG	Kelly Hemostat Forceps Curved, 6.25" Length	Each



German Carmalt Hemostat Straight, 6.25"

The German Carmalt Hemostat is characterized by the longitudinal serrations that run the length of the blade with cross-hatching at the tip. These large, crushing hemostatic forceps are used for clamping blood vessels and large tissues or ligating pedicles. The textured blades, along with the scissor like ratchet handles, ensure a strong grip of the clamped tissue with minimal chance of cutting the tissue during a procedure.

Item	Product Description	UOM
75316SG	German Carmalt Hemostat Straight, 6.25" Length	Each

**German Carmalt Hemostat Curved, 6.25"**

The German Carmalt Hemostat is characterized by the longitudinal serrations that run the length of the blade with cross-hatching at the tip. These large, crushing hemostatic forceps are used for clamping blood vessels and large tissues or ligating pedicles. The textured blades, along with the scissor like ratchet handles, ensure a strong grip of the clamped tissue with minimal chance of cutting the tissue during a procedure.

Item	Product Description	UOM
75316CG	German Carmalt Hemostat Curved, 6.25" Length	Each

**Scissors****LaGrange S-Shaped Scissors - Serrated**

Item	Product Description	UOM
54580	LaGrange S-Shaped Scissors - Serrated	Each

**Dean Scissors**

Item	Product Description	UOM
54581	Dean Scissors, 7" Length	Each

**Iris Scissors - SuperCut Curved Serrated**

Item	Product Description	UOM
75474C	Iris Scissors - SuperCut Curved Serrated, 4.75" Length	Each

**Iris Scissors - SuperCut Straight Serrated**

Item	Product Description	UOM
75474S	Iris Scissors - SuperCut Straight Serrated, 4.75" Length	Each



Needle Holders

Olsen Hegar Needle Holder with Scissors



Item	Product Description	UOM
75606	Olsen Hegar Needle Holder with Scissors, 5.5" Length	Each



Olsen Hegar Needle Holder, Tungsten Carbide



Olsen Hegar Needle Holder is an "all-in-one" needle holding instrument that features cross-serrated tips to hold the suture needle in addition to a built-in scissors to then cut the suture. This needle holder features tungsten carbide tips, gold finger ring handles and is constructed of high quality German stainless steel.

Item	Product Description	UOM
75614G	Olsen Hegar Needle Holder, Tungsten Carbide, 5.5" Length	Each
75616G	Olsen Hegar Needle Holder, Tungsten Carbide, 6.5" Length	Each



Mayo Hegar Needle Holder, Tungsten Carbide



The Mayo Hegar Needle Holder is a lockable, finger ring instrument available in a variety of sizes, and can be used in multiple types of surgical procedures. The Mayo Hegar Needle Holder is commonly used with larger, heavier suture.

Item	Product Description	UOM
75632G	Mayo Hegar Needle Holder, Tungsten Carbide, 6" Length	Each

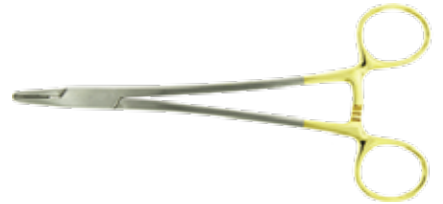

Tissue Forceps

German Adson 1 x 2 Tissue Forceps, 4.75"



Item	Product Description	UOM
54507	German Adson 1 x 2 Tissue Forceps, 4.75" Length	Each



German Adson Brown Tissue Forceps, 4.75"



Adson Brown Tissue Forceps are for holding and manipulating delicate tissues. These forceps have a wide, flat thumb grasp area that is commonly serrated. The jaws are short and the tips are narrow with 7 x 7 teeth.

Item	Product Description	UOM
75364G	German Adson Brown Tissue Forceps, 4.75" Length	Each



German Allis Tissue Forceps, 6"



German Allis Tissue Forceps is a surgical instrument with sharp teeth, used to hold or grasp heavy tissue.

Item	Product Description	UOM
75710G	German Allis Tissue Forceps, 6" Length	Each



Miscellaneous

German Backhaus Towel Clamps, 3.5"



German Backhaus Towel Clamps are a perforating clamp used for securing a towel or drape to the patient's skin by means of a small puncture. This product is curved with 1 x 1 perforating prongs.

Item	Product Description	UOM
75704G	German Backhaus Towel Clamps, 3.5" Length	Each



German Scalpel Handle #3



German Scalpel Handle #3 is compatible with size (10, 11, 12, 15) series disposable blades and used for sharp dissection. This handle has horizontal serrations for thumb and forefinger gripping, as well as a ruler on the back side.

Item	Product Description	UOM
75728G	German Scalpel Handle #3	Each



German Snook Ovariectomy Hook, 7"



The German Snook Ovariectomy Hook is used to retrieve the horn of the uterus when performing ovariectomy procedures on dogs and cats.

Item	Product Description	UOM
75724G	German Snook Ovariectomy Hook, 7" Length	Each



Instrument Kits

German Canine Spay / Neuter Pack



- 1 German Olsen Hegar Needle Holder 6.5" Tungsten Carbide
- 1 German Snook Hook 7"
- 1 German Mayo Scissors 6.75" Straight
- 1 German Adson Brown Forceps 4.75"
- 1 German Scalpel Handle #3
- 2 German Mosquito Hemostats 5" Straight
- 2 German Mosquito Hemostats 5" Curved
- 2 German Kelly Hemostats 5.5" Straight
- 2 German Kelly Hemostats 5.5" Curved
- 2 German Carmalt Hemostats 6.25" Curved
- 1 German Allis Tissue Forceps 6"
- 4 German Backhaus Towel Clamps 3.5"

Item	Product Description	UOM
75205	German Canine Spay / Neuter Pack	Each



German Feline Spay / Neuter Pack



- 1 German Olsen Hegar Needle Holder 5.5" Tungsten Carbide
- 1 German Snook Hook 7"
- 1 German Mayo Scissors 6.75" Straight
- 1 German Adson Brown Forceps 4.75"
- 1 German Scalpel Handle #3
- 2 German Mosquito Hemostats 5" Straight
- 2 German Mosquito Hemostats 5" Curved
- 2 German Kelly Hemostats 5.5" Straight
- 2 German Kelly Hemostats 5.5" Curved
- 4 German Backhaus Towel Clamps 3.5"
- 2 German Carmalt Hemostats 6.25" Curved

Item	Product Description	UOM
75210	German Feline Spay / Neuter Pack	Each



Equine Eye Pack



- Plastic Sterilization Tray
- Castroviejo Eye Speculum
- Bishop Harmon 1 x 2
- Chalazion Forceps 23 mm
- German Derf Needle Holder Tungsten Carbide
- Stevens Tenotomy Scissors Curved

Item	Product Description	UOM
75220	Equine Eye Pack	Each



Eye Pack



- Plastic Sterilization Tray
- Castroviejo Needle Holders
- Bishop Harmon 1 x 2
- Chalazion Forceps 20 mm
- Stevens Tenotomy Scissors Curved
- Wire Eyelid Speculum

Item	Product Description	UOM
75215	Eye Pack	Each

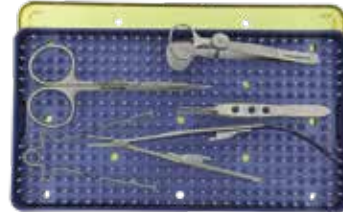

Vet Tech Pack



- SuperCut 5.5" Hi-Level Bandage Scissors
- 4.5" Littauer Stitch Scissors
- 5.5" 1 x 2 Thumb Tissue Forceps
- 5.5" Kelly Hemostat Straight
- Canvas Storage Pouch

Item	Product Description	UOM
75250	Vet Tech Pack	Each

**WE GAVE OUR NEW WEBSITE
A BREATH OF FRESH AIR!**

Visit maianimalhealth.com to browse all of our products.



Veterinary Technician Pack



The USI Vet Tech Pack was designed to provide veterinary technicians with a simple purchasing solution to provide the essential instruments for daily routine activities. The set includes 4 instruments and a canvas storage pouch.

Included in Vet Tech Pack (#75250):



(1) USI SuperCut 5.5" Hi-Level Bandage Scissors (#75460)



(1) USI 4.5" Littauer Stitch Scissors (#75470)



(1) USI 5.5" 1 x 2 Thumb Tissue Forceps (#75728)



(1) USI 5.5" Kelly Hemostat Straight (#75306S)



(1) Canvas Storage Pouch (#75251)

**ESSENTIAL INSTRUMENTS
FOR DAILY ACTIVITIES**

Item	Product Description	UOM
75250	USI Vet Tech Pack	Each

Warranty Information: 30 day unconditional guarantee on all products. Lifetime guarantee on USI brand instruments against defects in material and workmanship. Warranty does not cover wear and tear damage that naturally and inevitably occurs as a result of normal wear and usage.

See **page 115**
for more information!

HD Video Endoscope System MDS-VET™

The HD Video Endoscope is ideal for small and large animal practitioners providing a high quality, affordable endoscope for upper and lower GI examinations. With the 2.0 mm channel, the user may remove foreign bodies and check for pathology. Automatic air / water and suction port improves the ease and efficiency of procedures. Video Endoscope System includes: Biopsy Forceps, 3 Prong Grasper (only included with #48001-0, #48001-1 or #48001-2), Cleaning Brush, Case and Light Source.

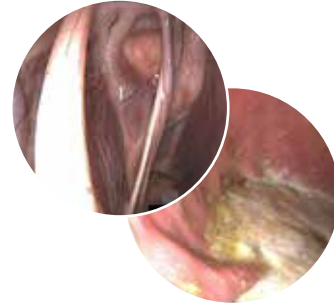

Item	Product Description	UOM
48001-0	HD Video Endoscope System, 2.0 mm Channel, 6 mm x 100 cm	Each
48001-1	HD Video Endoscope System, 2.0 mm Channel, 8 mm x 150 cm	Each
48001-2	HD Video Endoscope System, 2.8 mm Channel, 9.2 mm x 150 cm	Each
48001-3	HD Video Endoscope System, 3.2 mm Channel, 12.9 mm x 350 cm	Each
48000-0	HD Video Endoscope, 2.0 mm Channel, 6 mm x 100 cm - Scope Only	Each
48000-1	HD Video Endoscope, 2.0 mm Channel, 8 mm x 150 cm - Scope Only	Each
48000-2	HD Video Endoscope, 2.0 mm Channel, 9.2 mm x 150 cm - Scope Only	Each
48000-3	HD Video Endoscope, 3.2 mm Channel, 12.9 mm x 350 cm - Scope Only	Each
48002	HD Video Endoscope, 1.2 mm Channel, 3.5 mm x 55 cm - Scope Only	Each
48301	Light Source / Processor	Each
48053	Endoscopic Cart	Each

* Endoscopic Cart #48053 is not included - optional additional purchase. Cart subject to change and image may not reflect current product.



Video Output



4-way Articulation
Air / Water Valves



Endoscope Instruments

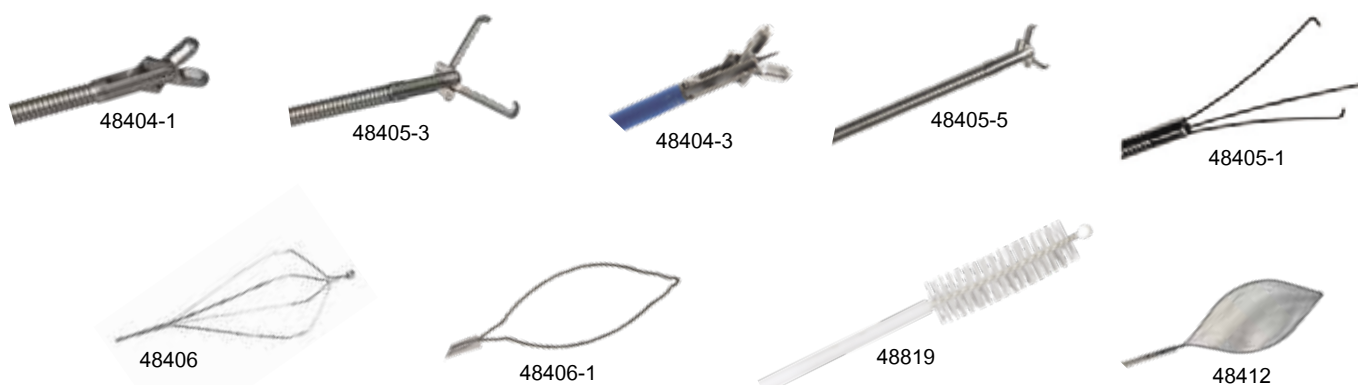

Item	Product Description	UOM
48404-1	Biopsy Forceps, 175 cm x 1.8 mm, Long Oval Cup	Each
48404-3	Biopsy Forceps, 175 cm x 1.8 mm, Long Oval Cup & Needle	Each
48405-3	Alligator Grasping Forceps, 175 cm x 1.8 mm	Each
48405-5	Rat-Tooth Grasping Forceps, 175 cm x 1.8 mm	Each
48405-1	3 Prong Foreign Body Retriever, 175 cm x 1.8 mm	Each
48406	Elliptical Basket, 4 Wire, 175 cm x 1.8 mm	Each
48406-1	Snare, Single Loop, 175 cm x 1.8 mm	Each
48403-3	Retractable Injector, 175 cm x 1.8 mm with 4 Single-Use Needles	Each
48819	Cleaning Brush, 175 cm x 1.8 mm - for Endoscopes	Each
48820	Cleaning Brush, 3.5 M x 2.3 mm - for Endoscopes	Each
48450	Guttural Pouch Probe, 175 cm x 1.8 mm	Each
48412	Roth Net, 2.3 mm x 230 cm, 3 cm Width	Each

DV-350 Surgical Suction Unit

The DV-350 Surgical Suction Unit is a portable and versatile high-vacuum, low-flow medical suction unit with a rechargeable battery pack providing approximately 40 minutes of on-the-go suctioning. Includes universal power adapter.

Item	Product Description	UOM
48110	DV-350 Surgical Suction Unit with 1,500 ml Canister (AC/DC Unit with Rechargeable Battery)	Each
48105	Replacement Suction Canister for DV-350 Surgical Suction Unit	Each
48106	Replacement Filter for DV-350 Surgical Suction Unit	Each
48107	Replacement Silicone Tubing for DV-350 Surgical Suction Unit	Each
48111	Replacement Rechargeable Battery for DV-350 Surgical Suction Unit	Each
39778	Suction Tubing (Attached)	Each

The DV-350 Surgical Suction Unit is manufactured by Cliq™, a division of DHCL Group (Anest Iwata Sparmax Co., Ltd).



Endoscopic Aspiration Kits

Designed to allow collection of cytology samples by aspiration of fluids through the biopsy channel of flexible fiber-optic endoscope.

- Thin-wall plastic tube with a luer connector at proximal end
- Stainless steel stylet used to assist in passage through the biopsy channel
- Approximately 35 cm longer than channel length
- Individually packaged and gamma irradiated or EtO exposed
- Single use item



Item	Product Description	UOM
64842	Endoscopic Aspiration Kit - 70 cm (for use with scopes having a 1.8 mm Diameter Channel, 70 cm Length)	Each
64840	Endoscopic Aspiration Kit - 80 cm (for use with Scopes having a 2.0 mm Diameter Channel, 80 cm Length)	Each
64845	Endoscopic Aspiration Kit - 1.1 M (for use with Scopes having a 2.0 mm Diameter Channel, 1.1 M Length)	Each
64830	Endoscopic Aspiration Kit - 1.4 M (for use with Scopes having a 2.0 mm Diameter Channel, 1.4 M Length)	Each
64835	Endoscopic Aspiration Kit - 1.7 M (for use with Scopes having a 2.0 mm Diameter Channel, 1.7 M Length)	Each
64838	Endoscopic Aspiration Kit - 2.5 M (for use with Scopes having a 2.0 mm Diameter Channel, 2.5 M Length)	Each

Endoscopic Culture Swabs

Endoscopic swabs use an endoscope's lumen channel in completing the procedure of swabbing potentially infected areas examined with an endoscope. Secured samples are transferred onto culture media or used in other diagnostic procedures. Swab's selection is based upon the endoscope length used by the practitioner.

- Designed to allow culturing through the biopsy channel
- Outer guarded tube helps protect the central swab from contamination upon insertion
- Distal end of tube has a water-soluble plug which is removed before taking the sample
- Calcium alginate swabs are attached to a stainless steel wire
- Calcium alginate fiber head for low pathogen toxicity
- Swab length easily reduced, with forceps provided, for transport after taking culture
- Individually packaged and gamma irradiated or EtO exposed
- Single use item



Item	Product Description	UOM
64855	Endoscopic Culture Swab - 1.1 M (for use with Scopes having a 2.0 mm Diameter Channel, 1.1 M Length)	Each
64850	Endoscopic Culture Swab - 1.4 M (for use with Scopes having a 2.6 mm Diameter Channel, 1.4 M Length)	Each
64852	Endoscopic Culture Swab - 1.7 M (for use with Scopes having a 2.6 mm Diameter Channel, 1.7 M Length)	Each
64853	Endoscopic Culture Swab - 2.4 M (for use with Scopes having a 2.6 mm Diameter Channel, 2.4 M Length)	Each
45425	Endoscopic Culture Swab - 3.3 M (for use with Scopes having a 2.6 mm Diameter Channel, 3.3 M Length)	Each
45427	Endoscopic Culture Swab - 3.8 M (for use with Scopes having a 2.6 mm Diameter Channel, 3.8 M Length)	Each



Exam Room Otoscope System

The Exam Room Video Otoscope System provides the small animal practitioner with a high quality, affordable otoscope system for patient examination and client education. Increase customer's confidence by demonstrating the latest technology in ear disease diagnosis and treatment. Camera and light source are compatible with other endoscopic equipment.

- Compatible with any laptop or tablet with a USB port*
- High quality optical endoscope
- Converts to 2.7 mm rhinoscope
- Color CCD camera
- 50-Watt LED light source and light cable
- Compact system

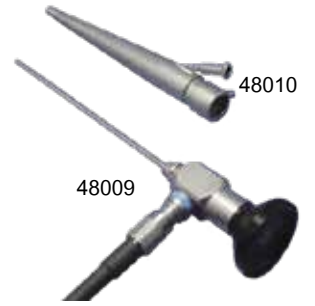

Item	Product Description	UOM
48008	Exam Room Video Otoscope System	Each
48304	50-Watt LED Light Source	Each
48217	Light Guide for 50-Watt LED Light Source	Each
48201	High-Resolution USB Endoscopy Camera	Each
48203	Focusing Endoscope Coupler	Each
48009	2.7 mm x 105 mm Rhinoscope	Each
48010	Otoscope Conversion Sheath	Each
48404	Biopsy-Jaw Forceps, 4.5FR, 8" Length	Each
48405	Alligator Foreign Body Forceps, 4.5FR, 8" Length	Each

* Laptop and tablet not included..

Video Otoscope System with Auri-Kleen™ Irrigation / Aspiration Machine

Complete system includes: Video Otoscope System, Auri-Kleen™ Irrigation / Aspiration Machine, Alligator Forceps and Biopsy Forceps.

Item	Product Description	UOM
48055	Video Otoscope System with Auri-Kleen™ Irrigation / Aspiration Machine	Each



Operating Otoscope Kit

Item	Product Description	UOM
48445	Operating Otoscope Kit	Each



Auri-Kleen™ Irrigation / Aspiration / Insufflation Machine

The Auri-Kleen™ Irrigation / Aspiration Machine is the latest technology in ear cleaning and treatment for diseases of the external and middle ear in canine and feline patients. The Auri-Kleen™ features a foot pedal-operated design allowing the operator to have an extra hand free for other tasks. Simply attach a 5FR (or smaller) catheter to the luer connector and insert into the ear canal.



Item	Product Description	UOM
48100	Auri-Kleen™ Irrigation / Aspiration Machine	Each
48105	Replacement Suction Canister, 1,500 ml	Each
48106	Replacement Suction Filter for Auri-Kleen™ Irrigation / Aspiration Machine & DV-350 Surgical Suction Unit	Each
48107	Replacement Silicone Tubing Assembly, 7 ft, for Auri-Kleen™ Irrigation / Aspiration Machine	Each
48108	Auri-Kleen™ Irrigation / Aspiration Machine Tubing & Filter Replacement Kit (includes #48106, #48107, 16" Large Silicone Tubing & 12" Small PVC Tubing)	Each

Portable Video Endoscope

The Portable Video Endoscope is the endoscopy solution for the veterinary professional on the move. This flexible, articulating video endoscope system operates without the use of an additional large light source or power source required by traditional systems. Additionally, everything needed to operate this endoscope kit fits in a small storage and carrying case for use in the field.

Features:

- 9.2 mm OD x 150 cm length
- 2.8 mm Biopsy Port (biopsy instrument included)
- 4-way articulation
- Air / Water Channel
- 1/18" CMOS Image Sensor
- Integrated 10-Watt Light Source
- 3" On-board LCD Monitor with recording capability (still images and video)
- Leak tester, cleaning kit and extra air / water button
- Field-ready storage and carrying case



Item	Product Description	UOM
48032	Portable Video Endoscope	Each

OtoKleen™ Ear Cleansing Solution for Dogs & Cats

OtoKleen™ is designed as a non-irritating surface cleaner to lift ear canal dirt and debris from the skin surface and removed via the vacuum action of the Auri-Kleen™ Irrigation / Aspiration Machine.

- Powerful wax dissolver
- Non-irritating formula
- Can be used with the Auri-Kleen™ Irrigation / Aspiration Machine
- Clean several ears with one bottle



Item	Product Description	UOM
48103	OtoKleen™ Ear Cleansing Solution for Dogs & Cats - 16 oz	Each

OtoKleen™ Ear Cleaning Cannulas

The disposable cannulas are very flexible with side ports to use in the ear canal to pulse along the side walls of the ear. By using the flexible tube which luer locks onto the Auri-Kleen™ system, the user is assured of proper cleansing of a patient's ears.

- Single use item

Item	Product Description	UOM
48104	OtoKleen™ Ear Cleaning Cannulas, Small 5FR	10/Bag
48101	OtoKleen™ Ear Cleaning Cannulas, Small 8FR	10/Bag
48102	OtoKleen™ Ear Cleaning Cannulas, Large 12FR	10/Bag

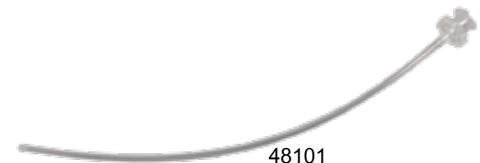

Instruments: Curettes & Forceps

The stainless steel, flexible Ear Loop Curette is an ideal tool for removing cerumen and plugs from ear canals. The 1.8 mm shaft is compatible with MedRx®, Storz® and most other video otoscope systems including a standard handheld otoscope. The Ear Loop Curettes are available in small (3 mm) or large (5 mm) sizes.

Item	Product Description	UOM
48408	Ear Loop Curette, Small Wire 3 mm Loop	Each
48410	Ear Loop Curette, Large Wire 5 mm Loop	Each
48405	Alligator Foreign Body Forceps, 4.5FR, 8" Length	Each
48404	Biopsy-Jaw Forceps, 4.5FR, 8" Length	Each
48405-2	Alligator Foreign Body Forceps, 4.5FR, 17" Length	Each
48404-2	Biopsy-Jaw Forceps, 4.5FR, 17" Length	Each

MEDRX is a registered trademark of MedRx, Inc.

STORZ is a registered trademark of Karl Storz GmbH & Co.



Flexible Micro-Endoscopes

The Flexible Micro-Endoscope is the smallest endoscope in the veterinary marketplace providing versatility in the diagnosis of diseases in the upper respiratory and urinary tracts of most companion animals, especially exotic animals. This endoscope is easily adaptable to existing light sources and video systems.

- 1.67 mm outside diameter (1 mm available)
- 10,000-fiber image bundle
- ACMI-Storz®-Wolf lightpost
- Compatible with most cameras
- Completely immersible
- Portable LED light source with 2 "CR123A" batteries (included)



Item	Product Description	UOM
48018	Flexible Micro-Endoscope, 1.67 mm x 20"	Each
48018-10	Flexible Micro-Endoscope, 1.67 mm x 10"	Each
48017	Flexible Micro-Endoscope, 1.0 mm x 8"	Each

Semi-Flexible Micro-Endoscopes

The Semi-Flexible Micro-Endoscope allows diagnostic capability in areas of the body that are usually inaccessible. Although designed to aid in the placement of endotracheal tubes in small mammals, this endoscope may be used for feline and canine rhinoscopy, otoscopy and cystoscopy. Adaptable to most video systems and light sources.

- Two sizes available:
 - ◆ 1.9 mm
 - ◆ 1.0 mm
- 10,000-fiber image bundle
- ACMI-Storz®-Wolf lightpost
- Compatible with most cameras
- Completely immersible
- Portable LED light source included

Item	Product Description	UOM
48012	Semi-Flexible Micro-Endoscope, 1.9 mm x 6"	Each
48015	Semi-Flexible Micro-Endoscope, 1.0 mm x 6"	Each
48020	Operating Sheath with 2 mm Channel for Semi-Flexible Micro-Endoscopes	Each
48335	Portable LED Light Source	Each



Bi-Valve Nasal Speculum

The MDS-Vet™ Bi-Valve Nasal Speculum is a lighted, spring-loaded speculum for the examination of oral, aural and any other orifice in exotic species. This item includes a “C” battery power handle, extra bulb, carrying case and batteries, and arrives ready to use. Pair with Item #48012 Semi-Flexible Micro-Endoscope for assisting in intubation procedures.

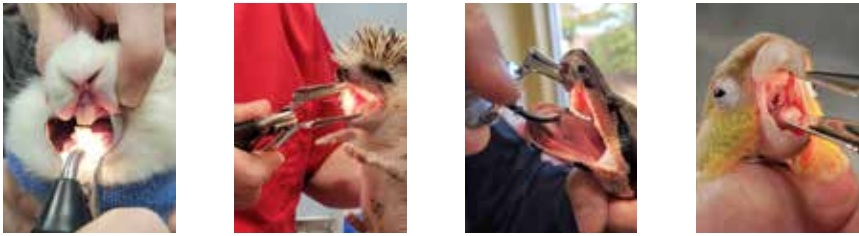

Item	Product Description	UOM
48446	Bi-Valve Nasal Speculum	Each

Rigid Endoscope System

The Rigid Endoscope System is a multi-purpose endoscope designed for rhinoscopy, cytoscopy, athroscopy and laparoscopy procedures.

Kit includes:

- Rigid Endoscope - Item #48035
- Operating Sheath - Item #48037
- Diagnostic Sheath with Dual Valves and Trocars - Item #48038
- Portable LED Light - Item #48335

Optional Add-Ons:

- Light Guide for 50-Watt LED Light Source - Item #48217
- High-Resolution USB Endoscopy Camera - Item #48201
- Focusing Endoscopy Coupler - Item #48203
- 50-Watt LED Light Source - Item #48304



Item	Product Description	UOM
48039	Rigid Endoscope System, 2.7 mm x 175 mm, 30 Degree with Operating Sheath, Diagnostic Sheath & Trocars	Each
48035	Rigid Endoscope System, 2.7 mm x 175 mm, 30 Degree	Each
48037	Operating Sheath with Operating Channel, Dual Stopcocks and Obturator for 2.7 mm x 175 mm, 30 Degree	Each
48038	Diagnostic Sheath with Dual Valves for 2.7 mm x 175 mm, 30 Degree	Each
48201	High-Resolution USB Endoscopy Camera	Each
48203	Focusing Endoscope Coupler	Each
48304	50-Watt LED Light Source	Each
48217	Light Guide for 50-Watt LED Light Source	Each
48335	Portable LED Light Source	Each



Transcervical Insemination Endoscope Kits

The MDS-Vet™ Transcervical Insemination Endoscope Kit is an affordable and effective solution for artificial insemination. The kit is adaptable to most existing light sources and video systems. The operating sheath will accommodate a 5FR catheter for semen delivery, as well as dual stopcocks for insufflation / irrigation and suction.

Kit includes:

- Endoscope - three versions available
- 7 mm operating sheath with 2 mm operating channel (6FR) and dual stopcocks
- Lightpost adapters for ACMI-Storz®-Wolf
- Insufflation bulb
- Portable LED Light Source - Item #48335

Optional Add-Ons:

- 50-Watt LED Light Source - Item #48304
- Light Guide for 50-Watt LED Light Source - Item #48217
- High-Resolution USB Endoscopy Camera - Item #48201
- Focusing Endoscopy Coupler - Item #48203

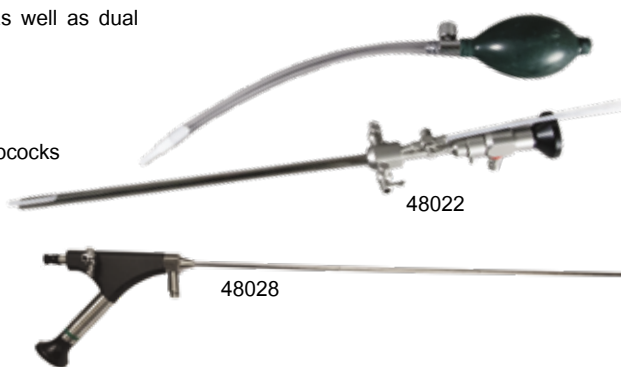

Item	Product Description	UOM
48022	Transcervical Insemination Endoscope Kit, 4 mm x 302 mm	Each
48025	Transcervical Insemination Endoscope Kit, 4 mm x 380 mm	Each
48028	Transcervical Insemination Endoscope Kit, 6 mm x 430 mm	Each

Small Ruminant Laparoscopic Insemination Kit for Deer / Small Ruminant

The MDS-Vet™ Laparoscopic Insemination System is a portable, economical kit to make laparoscopy procedures easier and more available to veterinarians offering laparoscopic services. This system provides a producer an opportunity to maximize reproductive potential.

Kit includes:

- Laparoscope - Item #48443
- 5.5M Trocar - Item #48440
- Portable LED Light Source - Item #48335

Optional Add-Ons:

- Babcock Forceps - Item #48402
- High-Resolution USB Endoscopy Camera - Item #48201
- Focusing Endoscopy Coupler - Item #48203



Item	Product Description	UOM
48030	Laparoscopic Insemination Kit for Deer / Small Ruminant	Each
48440	5.5M Trocar	Each
48443	Laparoscope, 5 mm x 302 mm, 0 Degree	Each
48335	Portable LED Light Source	Each
Optional Add-Ons		
48402	Babcock Forceps	Each
48201	High-Resolution USB Endoscopy Camera	Each
48203	Focusing Endoscope Coupler	Each

*Indicates optional item.

Endoscope Video Adapters

Item	Product Description	UOM
48043	Endoscope Video Adapter for iPod Touch	Each
48216	Olympus Eyepiece Adapter	Each

* #48043 - iPod Touch not included - purchase separately.



Vetcorder™ Pro Portable Patient Monitor



Vetcorder™ Pro is an affordable, handheld touchscreen multi-parameter monitor capable of monitoring ECG, SpO2 and internal temperature. Vetcorder™ Pro excels in under-monitored areas of the clinic such as radiology, recovery and transport. Two free apps for Android and iOS mirror the Vetcorder™ Pro via Bluetooth to a phone or tablet, giving the veterinary team real-time, increased visibility of patient status from a distance. Continuously monitor patients from admission to discharge.

Features:

- Multi-Parameter - continuously monitor ECG, SpO2, internal temperature and heart rate of patients
- Up to 12 hours of battery life - fully charges in 3 hours
- Heart Rate monitoring range of 30-350 bpm
- Pocket size and touchscreen with durable protective case
- Monitor Vitals app enables recording of vitals and patient monitoring from up to 30 feet away and transfers data to iOS or Android via Bluetooth
- Vetcorder™ Connect app enables 30, 60 or 90 second ECG recordings and the ability to view, save and share recordings (via PDF - email or print)
- Daily Checks - Save 30-second clips of ECG, SpO2 %, Heart Rate and PI under a patient file and track data over time
- Can be used to monitor companion animals, exotics, reptiles, equine, pocket pets and even wildlife and zoo animals
- Can be used in the clinic or out in the field



48561



Item	Product Description	UOM
48561	Vetcorder™ Pro Portable Patient Monitor with Temperature Cable System	Each



NEED ACCESSORIES?

Additional accessories are available to complete your Vetcorder™ System! See page 127 for a full list.

Vetcorder™ Pro Portable Patient Monitor Frequently Asked Questions:

What does my Vetcorder™ Pro come with?

The Vetcorder™ Pro System includes one Vetcorder™ Pro, a protective case with integrated cable adapter, an SpO2 lingual sensor, one 2-lead ECG with two sets of clips, one temperature cable for measuring core temperature, one extension cable and a USB charging cable with AC adapter.

Will the Vetcorder™ Pro work with large animals and/or exotics?

YES! A Large Animal Accessory Kit Item #48526 can be purchased separately. The Vetcorder™ Large Animal Accessory Kit includes two tri-parameter extension cables, an SpO2 Reflectance Sensor and carrying pouch. Zumaya ECG Needle Electrodes are also available for exotic patients.

What is the warranty on a Vetcorder™ Monitor?

Every Vetcorder™ Pro System purchase comes with a free in-service training with one of our product experts. We also provide technical support via phone or our support page on this website. The Vetcorder™ Pro and protective case is covered by a 1 year warranty against manufacturing defects. Other accessories are covered by a 6 month warranty against manufacturing defects.

Can I use my Vetcorder™ Pro in dental? What if it gets wet?

This is an ideal use of the Vetcorder™ Pro. Using it's Bluetooth feature you can keep the monitor close to your patient under a blanket to prevent it from getting wet, all while viewing it on a phone or tablet in front of you via two FREE apps - Vetcorder™ Connect and Monitor Vitals.



Vetcorder Airmate™ Capnograph System



The Vetcorder Airmate™ is a fast, convenient, portable and reliable capnograph that uses sidestream technology to accurately track end-tidal CO₂ (EtCO₂) and can also monitor respiratory rate (RR) and apnea. Suitable for both large and small animal monitoring from induction to recovery. Monitoring patients with a capnograph during anesthetic procedures increases patient safety and instills confidence in staff and pet parents. Vetcorder Airmate™ offers portable convenience for hospital, clinic or in-the-field procedures.

Features:

- Small and lightweight at 5.6" W x 1.5" D x 3" H
- Portable - fits in pocket or palm of hand
- Uses standard tubing with luer lock connectors
- Easy to use - pressing one button starts measurement monitoring
- Easy to read, high resolution color anti-glare touch screen
- Automatic screen rotation to aid in viewing waveform data
- Multiple alarms for upper and lower EtCO₂, RR, apnea and filter life
- Optional low dead space adapters available
- Rechargeable battery - continuous use up to 12 hours
- Can be used on a wide variety of species - companion animals, equine, livestock, wildlife and zoo animals

Includes:

- Vetcorder Airmate™ Capnograph
- 8 ft standard tubing with luer lock connectors
- 6 moisture filters
- Charging block and cable
- 1 year parts and labor warranty against manufacturer defect
- In-service training
- All repairs and services will be performed at our facilities in the USA



48520



48531

Item	Product Description	UOM
48520	Vetcorder Airmate™ Capnograph, Standard	Each
48517	Adapter, Straight Gas Sampling Tube, Luer	Each
48519	Adapter, Elbow Gas Sampler Tube	Each
48521	Tube, Sampling, Luer-M to Luer-M, 8 ft	Each
48552	Vetcorder Airmate™ Moisture Filter	5/Pack
48553	Vetcorder Airmate™ Moisture Filter	25/Pack
48531	Protective Silicone Cover for Vetcorder Airmate™	Each

Vetcorder Airmate™ Frequently Asked Questions:

What is included with the Vetcorder Airmate™?

Vetcorder Airmate™ Capnograph System – Includes unit, straight airway sample adapter, sampling tubing and moisture filters. (NOTE: Low dead space adapters for smaller patients are available and sold separately).

Is a sidestream capnograph good for my dental suite?

YES! This technology is actually preferred for dental work as the analyzer is away from the patient. Air is drawn through the tube by a pump to the device for measurement instead of from a sensor directly mounted on the end of the endotracheal tube.

How hard is it to get filters or tubing for the Vetcorder Airmate™?

Vetcorder Airmate™ uses standard tubing and is easy to find and replace via website or distributor. Moisture filters are sold in packs of 5 or packs of 25.

What if I need service?

If you need service on your Vetcorder Airmate™ (or any other Vetcorder™ monitor), all service is handled by trained professionals in the United States.



Vetcorder™ Pro + Vetcorder Airmate™ Combo

Together the combo package option of the Vetcorder™ Pro and Vetcorder Airmate™ can often replace outdated bulky monitoring systems. ECG, SpO2, EtCO2, internal temperature can all be monitored between two handheld devices that fit in your pocket or the palm of your hand.

Combo bundle includes:

- Vetcorder™ Pro Portable Patient Monitor
- Vetcorder Airmate™ Capnograph, Standard
- Small Animal SpO2 Lingual Sensor, 2 ft
- Small Animal ECG Cable, 2 ft Gen 2
- Small Animal ECG Clips (Electrodes) Silver, 2 pieces
- Small Animal ECG Clips (Electrodes) Blue, 2 pieces
- USB Charging Cable, Micro D
- USB Wall Charging Adapter Assembly
- Moisture Filter for Vetcorder Airmate™
- Vetcorder™ Pro Temperature Bundle - includes Vetcorder™ Pro Temperature Probe 3' Cable and Tri-Parameter Patient Extension Cable 1 m



Item	Product Description	UOM
48562	Vetcorder™ Pro Portable Patient Monitor + Vetcorder Airmate™ Capnograph, Combo	Each
48532	Small Animal SpO2 Lingual Sensor, 2 ft	Each
48533	Small Animal ECG Cable, 2 ft Gen 2	Each
48534	Small Animal ECG Clips (Electrodes) Silver, (2 Pieces)	Each
48534BL	Small Animal ECG Clips (Electrodes) Blue, (2 Pieces)	Each
48535	USB Charging Cable, Micro D	Each
48536	USB Wall Charging Adapter Assembly	Each
48552	Moisture Filter for Vetcorder Airmate™	5/Pack
48565	Vetcorder™ Pro Temperature Bundle: includes #48564 Vetcorder™ Pro Temperature Probe 3' Cable and #48566 Tri-Parameter Patient Extension Cable, 1 m	Each



Vetcorder™ Accessories

Item	Product Description	UOM
48526	Vetcorder™ Pro Large Animal Accessory Kit (includes #48566 Patient Extension Cable, #48541 Small & Large Animal SpO2 Sensors & #48543 Carrying Case)	Each
48564	Vetcorder™ Pro Temperature Cable (Internal Temperature Probe), 3 ft	Each
48566	Tri-Parameter Extension Cable, 1 m	Each
48532	Small Animal SpO2 Lingual Sensor, 2 ft	Each
48533	Small Animal ECG Cable, 2 ft	Each
48534	Small Animal ECG Clips (Electrodes) Silver, (2 Pieces)	Each
48534BL	Small Animal ECG Clips (Electrodes) Blue, (2 Pieces)	Each
48544	Small Animal SpO2 Lingual Clip (Clip Only)	Each
48546	Zumaya™ ECG Needle Electrodes (3 Pair)	Each
48535	USB Charging Cable, Micro D	Each
48536	USB Wall Charging Adapter Assembly	Each
48538	Minimonitor Adapter (only for Vetcorder™ Classic)	Each
48541	Small & Large Animal SpO2 Reflectance Sensor, 2 ft	Each
48543	Vetcorder™ Pro Carrying Case	Each
48570	Vetcorder™ Hanging Accessory	Each



* Carabiner not included with Vetcorder™ Hanging Accessory.



CAT+ Doppler / Blood Pressure Monitor Cuffs

A variety of different sized blood pressure cuffs to accommodate monitoring both cats and dogs.

- Latex-free

Item	Product Description	UOM
48518-1	CAT+ Doppler / Blood Pressure Cuff - Size 1 (4 cm to 7 cm)	Each
48518-2	CAT+ Doppler / Blood Pressure Cuff - Size 2 (5 cm to 8 cm)	Each
48518-3	CAT+ Doppler / Blood Pressure Cuff - Size 3 (7 cm to 10 cm)	Each
48518-4	CAT+ Doppler / Blood Pressure Cuff - Size 4 (8 cm to 13 cm)	Each
48518-5	CAT+ Doppler / Blood Pressure Cuff - Size 5 (10 cm to 16 cm)	Each
48518-6	CAT+ Doppler / Blood Pressure Cuff - Size 6 (16 cm to 21 cm)	Each
48518-7	CAT+ Doppler / Blood Pressure Cuff - Size 7 (17 cm to 25 cm)	Each

* Note: Item #48515 CAT+ Doppler is discontinued. Cuff accessories will continue to be sold for existing units.



HAVE YOU 'HERD' ABOUT OUR BRAND NEW WEBSITE?



Visit

maianimalhealth.com

to browse all of our products.



One Puff™ Aspirator / Resuscitator Kits



PATENTED

The McCulloch Medical™ One Puff™ Aspirator / Resuscitator Kit is the simple, two-part, handheld instrument that clears breathing pathways and stimulates the first breaths of newborn puppies, kittens and other small animals. One Puff™ is the safe and effective alternative to the use of traditional methods, such as shaking, swinging or mouth-to-mouth. An invaluable tool for all veterinarians, breeders and pet owners, the One Puff™ has saved hundreds of distressed newborns since its introduction.

- Aspirator Pump "A" administers a safe vacuum suction to remove mucus from animal, while Resuscitator Pump "B" provides a small release of air to stimulate respiratory response
- Uses a controlled amount of air (5 ml to 10 ml)
- Resuscitator Pump "B" features ability to be attached directly to oxygen
- Resuscitator Mask "B" can be detached and used as an oxygen and/or anesthesia mask
- Easily cleaned in 1:20 solution of bleach and water
- 2 year warranty against manufacturer defects

One Puff™ Newborn Aspirator / Resuscitator Kit, Puppy & Kitten

- Kit includes: Aspirator Pump / Mask labeled "A", Resuscitator Pump / Mask labeled "B", Carrying Case and instructions
- Designed specifically for use on newborn puppies and kittens; especially effective for C-section births

Item	Product Description	UOM
55325	One Puff™ Aspirator / Resuscitator Kit, Puppy & Kitten	Each
55326	One Puff™ Aspirator / Resuscitator Kit, Puppy & Kitten - Brachycephalic	Each
55395	One Puff™ Replacement O-Ring	2/Bag
55351	Anesthesia Mask, Puppy & Kitten	Each
55420	Diaphragm for Mask, Puppy / Kitten / Raptor	Each
55426	Diaphragm for Mask, Puppy / Kitten / Raptor - Brachycephalic	Each



One Puff™ Aspirator / Resuscitator Kit, Raptor

- Kit includes: Aspirator Pump / Mask labeled "A", Resuscitator Pump / Mask labeled "B", Carrying Case and instructions
- Specially designed for use on birds

Item	Product Description	UOM
55315	One Puff™ Aspirator / Resuscitator Kit, Raptor	Each
55395	One Puff™ Replacement O-Ring	2/Bag
55420	Diaphragm for Mask, Puppy / Kitten / Raptor	Each

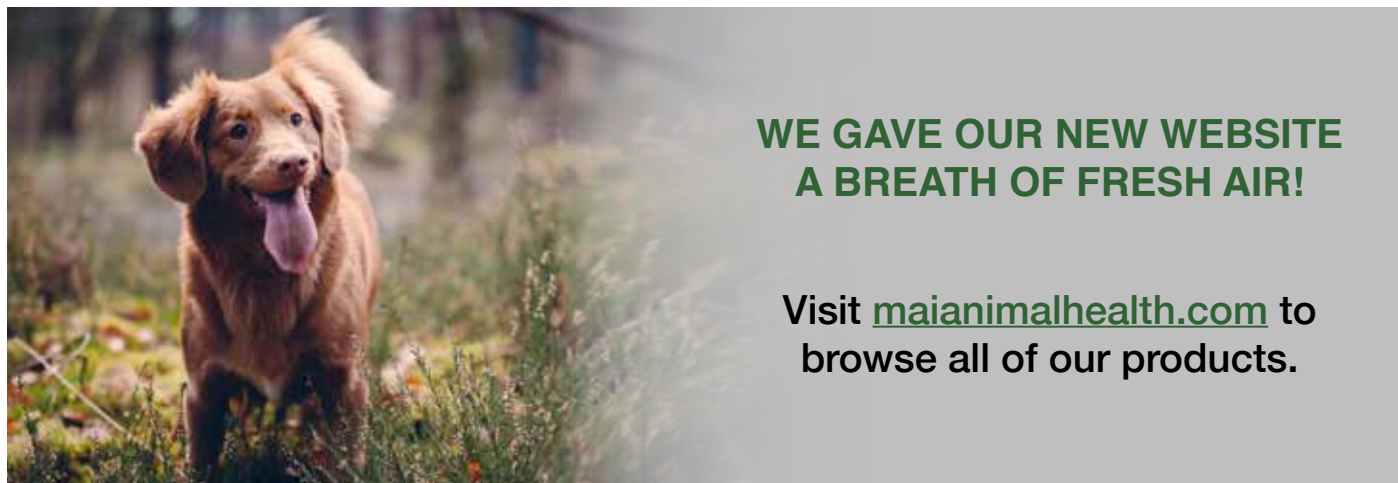

**WE GAVE OUR NEW WEBSITE
A BREATH OF FRESH AIR!**

Visit maianimalhealth.com to
browse all of our products.



Oxygen Recovery Masks

- Facilitate post-surgery, post-trauma and post smoke inhalation patient recovery
- Mask body is manufactured from durable polycarbonate
- Diaphragm is made from tear-resistant thermoplastic material and is inert with polycarbonate for longer life
- Mask features dual vents, not valves, to ensure unrestricted inhalation and exhalation to prevent unforeseen reduction or increase in oxygen flow
- Includes a rubber-mounted 22 mm oxygen adapter and 7 ft of oxygen tubing
- Designed to be used with oxygen tanks
- Easily cleaned in 1:20 solution of bleach and water
- Optional hook and strap sets available to secure the McCulloch Medical™ masks
- Used by fire departments around the world
- 2 year warranty against manufacturer defects



Item	Product Description	UOM
55358	Oxygen Recovery Mask, Small	Each
55360	Oxygen Recovery Mask, Large	Each
55362	Oxygen Recovery Mask, Feline	Each
55363	Oxygen Recovery Mask, Puppy & Kitten	Each
55359	Oxygen Recovery Mask, Raptor	Each

Anesthesia Masks

- Masks cover wide range of animals, from calves and foals to puppies, kittens and raptors
- Mask body is manufactured from durable polycarbonate
- Diaphragm is made from tear-resistant thermoplastic material and is inert with polycarbonate for longer life
- Diaphragms can be replaced unlike cheap masks
- Easily cleaned in 1:20 solution of bleach and water
- 2 year warranty against manufacturer defects



Item	Product Description	UOM
55346	Anesthesia Mask, Small	Each
55348	Anesthesia Mask, Large	Each
55350	Anesthesia Mask, Feline	Each
55351	Anesthesia Mask, Puppy & Kitten	Each
55345	Anesthesia Mask, Raptor	Each

Aerosol Therapy Masks

- Side port accepts both a metered-dose inhaler (MDI) and 22 mm connector to a nebulizer*
- Mask body is manufactured from durable polycarbonate
- Diaphragm is made from tear-resistant thermoplastic material and is inert with polycarbonate for longer life
- Easily cleaned in 1:20 solution of bleach and water
- 2 year warranty against manufacturer defects



Item	Product Description	UOM
55352	Aerosol Therapy Mask, Small	Each
55354	Aerosol Therapy Mask, Large	Each
55356	Aerosol Therapy Mask, Feline	Each
55357	Aerosol Therapy Mask, Puppy & Kitten	Each

*Nebulizer and medicine not included.



Diaphragms & Accessories for McCulloch Medical™ Masks



Item	Product Description	UOM
55422	Diaphragm, Mask, Small / Feline	Each
55424	Diaphragm, Mask, Large	Each
55420	Diaphragm, Mask, Puppy / Kitten / Raptor	Each
55421	Diaphragm, Mask, Brachycephalic	Each
55430	Swivel Elbow Connector, 22/15	Each
55434	Oxygen Tubing, 7 ft - .210" Internal Diameter of Adapter on End of Tube	Each



Respiratory Training Models



- Life-like muzzles
- Clear window over thoracic area for lung observation

Puppy Training Model

Item	Product Description	UOM
55500	Training Model, Puppy	Each



Canine Training Model

Item	Product Description	UOM
55503	Training Model, Canine	Each



Foal Training Model

Item	Product Description	UOM
55506	Training Model, Foal	Each



Calf Training Model

Item	Product Description	UOM
55509	Training Model, Calf	Each



McCulloch Medical™ Aspirator / Resuscitator Kits

The McCulloch Medical™ Aspirator / Resuscitator Kit is an effective, all-in-one device used to clear respiratory passages and pump air into a struggling newborn animal's lungs. The Aspirator / Resuscitator has been developed, tested and proven globally over 16 years for use with newborn animals in respiratory arrest or having difficulty breathing. Ideal for use with animals requiring resuscitation in post-trauma, drowning or smoke-inhalation status. This simple and convenient instrument aspirates on one end and resuscitates on the other, delivering an appropriate volume of air with or without oxygen. McCulloch Medical™ Aspirator / Resuscitator Pumps are available in four sizes based on the weight of the animal and can be matched with a variety of Aspirator / Resuscitator Mask sizes. A vital tool for all veterinarians, farmers, breeders and pet owners.

- Easy-to-use and convenient - only one person is needed to operate system using simple push-pull action
- Safe, effective and humane - eliminates traditional revival methods such as shaking or swinging
- Pumps and Masks are long lasting and durable - accompanied by a 2 year warranty against manufacturer defects
- Easily cleaned in 1:20 solution of bleach and water
- Supplemental Oxygen Adapter available, offering ability to resuscitate with or without oxygen
- May be purchased in a convenient kit specific to an animal species

Foal Aspirator / Resuscitator Kit with Oxygen Recovery Mask

Kit includes: Aspirator / Resuscitator Pump, Aspirator Mask, Resuscitator Mask, Supplemental Oxygen Adapter, Oxygen Recovery Mask, Carrying Case and instructions.

Item	Product Description	UOM
55301	Aspirator / Resuscitator Kit, Foal	Each



Calf Aspirator / Resuscitator Kit

Kit includes: Aspirator / Resuscitator Pump, Aspirator Mask, Resuscitator Mask, Carrying Case and instructions. Supplemental Oxygen Adapter and Oxygen Recovery Mask sold separately.

Item	Product Description	UOM
55310	Aspirator / Resuscitator Kit, Calf	Each



Lamb / Kid / Alpaca / Cria / Miniature Foal Aspirator / Resuscitator Kit

Kit includes: Aspirator / Resuscitator Pump, Aspirator Mask, Resuscitator Mask, Carrying Case and instructions. Supplemental Oxygen Adapter and Oxygen Recovery Mask sold separately.

Item	Product Description	UOM
55320	Aspirator / Resuscitator Kit, Lamb, Kid, Alpaca, Cria, Miniature Foal	Each



Piglet Aspirator / Resuscitator Kit

Kit includes: Aspirator / Resuscitator Pump, Aspirator Mask, Resuscitator Mask, Carrying Case and instructions. Supplemental Oxygen Adapter and Oxygen Recovery Mask sold separately.

Item	Product Description	UOM
55330	Aspirator / Resuscitator Kit, Piglet	Each





Aspirator / Resuscitator Pumps



- Pushes air out or sucks air in, based on which end you place the mask on

Item	Product Description	UOM
55332	Aspirator / Resuscitator Pump for 1.1 lb to 3.3 lb (0.5 kg to 1.5 kg) Patient	Each
55334	Aspirator / Resuscitator Pump for 6.6 lb to 22 lb (3 kg to 10 kg) Patient	Each
55336	Aspirator / Resuscitator Pump for 24 lb to 55 lb (11 kg to 25 kg) Patient	Each
55338	Aspirator / Resuscitator Pump for 57 lb to 172 lb (26 kg to 78 kg) Patient	Each



Aspirator Masks



- Attaches to the large end of an Aspirator / Resuscitator Pump to aspirate

Item	Product Description	UOM
55366	Aspirator Mask, Small	Each
55368	Aspirator Mask, Large	Each
55370	Aspirator Mask, Feline	Each



55366 55368 55370

Resuscitator Masks



- Attaches to the narrow end of an Aspirator / Resuscitator Pump to resuscitate

Item	Product Description	UOM
55340	Resuscitator Mask, Small	Each
55342	Resuscitator Mask, Large	Each
55344	Resuscitator Mask, Feline	Each



55340 55342 55344

Supplemental Oxygen Adapters



- Attaches to the large end of an Aspirator / Resuscitator Pump with the other end attaching to an oxygen tank

Item	Product Description	UOM
55372	Supplemental Oxygen Adapter, Small	Each
55374	Supplemental Oxygen Adapter, Large	Each



55372 55374





Anesthesia Chambers

Anesthesia Chambers allow a method of anesthetic induction without use of short-acting barbiturates. Removable dividers accommodate various size animals - eliminating wasted gas and saving money. Closed airtight system creates a healthy atmosphere for working staff. Using the chamber allows a quick and humane induction method to patient, with less anesthetic exposure to veterinarian and staff during a potentially difficult procedure. Lid seals tightly preventing loss of anesthetic gas.

Anesthesia Chamber, Mini

Smallest size chamber with removable divider. Holds small rodents, reptiles and birds.

Item	Product Description	UOM
55205	Anesthesia Chamber, Mini - 10" H x 5-1/2" W x 5-1/2" L	Each

Anesthesia Chamber, Small

Includes removable divider. Smaller patients only. Holds up to approximately a 10 lb animal.

Item	Product Description	UOM
55212	Anesthesia Chamber, Small - 16" H x 7" W x 7" L	Each

Anesthesia Chamber, Large

Includes removable divider offering three variable-sized compartments for a small dog to a large size cat up to 15 lbs.

Item	Product Description	UOM
55215	Anesthesia Chamber, Large - 21" H x 7" W x 7" L	Each

Anesthesia Chamber, Magnum

Largest size chamber. Includes two removable dividers offering three different compartments. Holds a wide range of animals, from extremely small patients up to small dogs.

Item	Product Description	UOM
55217	Anesthesia Chamber, Magnum - 23" H x 9" W x 9" L	Each

Anesthesia Chamber, Magnum 4-Latch

Magnum Chamber featuring entirely removable lid.

Item	Product Description	UOM
55255	Anesthesia Chamber, Magnum 4-Latch - 23" H x 9" W x 9" L	Each

Anger Management™ Chamber PATENTED

Two doorway system - top and end door enables user to place cage or kennel directly at the end of the chamber. Sliding door enables user to "quickly" slide door closed; enclosing patient without moving the cage or kennel.

Item	Product Description	UOM
55235	Anger Management™ Chamber - 23" H x 10" W x 9" L	Each

Cage (In-Place) Chamber™ SENTIER

Specifically designed for induction of mice or rat colonies while maintaining their current environment to reduce undue colony stressors.

Item	Product Description	UOM
55213	Cage (In-Place) Chamber™	10/Set



The Whiplash™ Complete



The Whiplash™ Complete is the superior system for delivering liquid medicants, nutritionals, electrolytes, mineral oil, bloat remedies or high volumes of fluids. The Med-Eze™ Stomach Pump is stainless steel, durable, low maintenance and delivers one liter of fluids in three strokes.

- Includes: The Whiplash™ Flexible Stainless Steel Stomach Tube, Med-Eze™ Stomach Pump and 6 ft of durable rubber hose
- Dual action, may be used to pump fluids or with accessory Suction Adapter (Item #76816) to extract stomach / rumen content or uterine fluid
- Flexible, stainless steel construction
- Med-Eze™ Stomach Pump reliably delivers 335 ml per stroke; three strokes deliver one liter
- Highly polished bulb has end and side exit ports
- Elongated probe completely enters rumen and allows for high volume fluid delivery
- Available in 60" and 80" lengths
- Nose clamp allows oral delivery without assistance



Item	Product Description	UOM
76004	The Whiplash™ Complete with Pump, Rubber Hose & Flexible Stainless Steel Stomach Tube, 60"	Each
76005	The Whiplash™ Complete with Pump, Rubber Hose & Flexible Stainless Steel Stomach Tube, 80"	Each
76051	The Whiplash™ Flexible Stainless Steel Stomach Tube, 60" with Nose Lead	Each
76052	The Whiplash™ Flexible Stainless Steel Stomach Tube, 80" with Nose Lead	Each

Med-Eze™ Oral Delivery Pump



The universal pump for oral delivery of liquid nutritionals and medicants.

- Leakproof delivery pump
- Durable stainless steel construction eliminates corrosion
- Easy and consistent delivery of product
- Reduces arm and shoulder fatigue
- Three strokes deliver one liter
- Designed for oral delivery of drenches, fluids and nutraceuticals
- Includes: Med-Eze™ Oral Delivery Pump, 6 ft of plastic tubing and rigid plastic L-shaped oral probe



Item	Product Description	UOM
34123	Med-Eze™ Oral Delivery Pump	Each

Med-Eze™ Cart Pump



- Mobile and versatile system for high volume delivery of Up & Over™ Plus and other oral liquids or gels
- 15 gallon capacity
- Increased mobility and product capacity
- Easy and consistent delivery of product
- Durable cart with all plastic construction reservoir
- Designed for use with The Whiplash™ Flexible Stainless Steel Stomach Tube
- Also available in custom / modified versions

Item	Product Description	UOM
76010	Med-Eze™ Cart Pump	Each



Med-Eze™ Stomach Pump

- Hose connection accommodates various size stomach tubes
- Dual action, may be used to pump fluids or with accessory Suction Adapter (#76810) to extract stomach / rumen content or uterine fluid
- Durable stainless steel construction
- Easy, consistent draw and delivery
- Reduces arm and shoulder fatigue
- Each stroke delivers 335 ml



Item	Product Description	UOM
34124	Med-Eze™ Stomach Pump	Each

Med-Eze™ & The Whiplash™ Oral Delivery System Accessories

Item	Product Description	UOM
76814	Adapter for 1" ID Stomach Tube	Each
76810	Adapter for 5/16" - 7/16" ID Stomach Tube	Each
76812	Adapter for 7/16" - 1" ID Stomach Tube	Each
76822	Bulb End for The Whiplash™ Stomach Tube	Each
76820	Chain for The Whiplash™ Stomach Tube with Nose Lead	Each
76100	Med-Eze™ Rubber Hose Replacement	Each
76805	Med-Eze™ Pump Piston	Each
76800	Med-Eze™ Pump Seal / Gasket Kit	Each
76816	Suction Adapter	Each



Silicone Stomach Tubes

Stomach tubes are used primarily with equine and bovine. It is a method used to relieve dehydration due to disease or after surgical procedures. By placing the tube in a patient's stomach and utilizing pumping or gravitational flow, one can readily deliver large volumes of fluids.

- Silicone is completely inert and resists deterioration, works well even in extreme cold weather
- Steam sterilize or wash with mild soap and water
- Attaches to the Med-Eze™ Stomach Pump to pump fluid or, if used with Suction Adapter, to extract fluids

Item	Product Description	UOM
39570	Silicone Stomach Tube, Small, 12 mm OD (36FR), 10 ft	Each
39571	Silicone Stomach Tube, Medium, 17 mm OD (51FR), 10 ft	Each
39572	Silicone Stomach Tube, Large, 19 mm OD (57FR), 10 ft	Each



Funnels

Item	Product Description	UOM
39573-4	Funnel, 4 oz	Each
39573-8	Funnel, 8 oz	Each
39573-16	Funnel, 16 oz	Each



550 ml Syringe

- All plastic construction
- 550 ml maximum capacity
- Length 15.5"
- Polypropylene graduated or non-graduated barrel
- Durable plunger system for ease in filling and dispensing
- Used for oral delivery of fluids and medicants including nutritionals
- Ideal for oral rinsing in Equine Dentistry
- Includes standard plastic oral nozzle, stainless steel also available
- Removable caps on both ends of the barrel for ease in assembly, disassembly and cleaning



Item	Product Description	UOM
60400	550 ml Syringe	Each
70860	Nozzle, Long Drench - Stainless Steel with .280" ID	Each

Bottle Brush

- 22" length provides easier handling than 18" brushes offered by most competitors
- Heavy duty galvanized wire handle and shaft with convenient hanging loop on handle
- Stiff, food grade brush material with smooth loop at the bristle end
- Flexible and no sharp edges
- Reaches inside the handle of the HANDI GRIP™ 4 Quart / 4 Liter Bottle and 5 & 6 Liter Back Packs



Item	Product Description	UOM
39805	Bottle Brush, 22"	Each

Calf-Maid® Bottles

- Sturdy, high density bottle with rollover neck finish
- Unique patented nipple provides calves with continuous milk flow when utilizing the nipple feeder
- Rollover nipple securely affixes on the feeder container tightly, avoiding potential leakage
- One-piece rollover nipple with strategic vent allows for ease in cleaning and maintenance
- Improves calf's ability to suckle without taking in large volumes of air



Item	Product Description	UOM
39519	Calf-Maid® Bottle, 2 Quart	Each
39523	Calf-Maid® Bottle, 3 Quart / 3 Liter, Straight Wall, Snap On	Each
39524	Calf-Maid® Bottle, 3 Quart / 3 Liter, Straight Wall, Threaded	Each
39522	Calf-Maid® Bottle, 4 Quart / 4 Liter	Each
39800	Calf-Maid® Nipple, Black	Each
39801	Calf-Maid® Nipple, Red, for Threaded Bottle	Each

Calf Bottles with Nipple

- Sturdy, high density polyethylene bottle with screw top neck finish to accommodate ring and nipple
- Storage cap allows for storage of fresh or frozen colostrum



Item	Product Description	UOM
39400	Adapt-A-Bottle™ 2 Liter (Bottle, Ring, Nipple & Storage Cap)	Each
39401	Adapt-A-Bottle™ 3 Liter (Bottle, Ring, Nipple & Storage Cap)	Each



HANDI GRIP™ Feeder & Storage Bottles

Uniquely designed 4 quart / 4 liter bottle used for colostrum storage, as a feeder bottle with a nipple and as a reservoir when attached to an esophageal probe in feeding or providing electrolytes to calves.

- High density polyethylene bottle with flat side walls and large handle
- 70 mm threaded neck finish allows easy cleaning and filling
- Uniquely designed easy grip handle enables user to tilt the container at any angle and maintain control
- Specialty caps provide adaptability allowing the container to be used as a nipple feeder, an oral esophageal feeder or a storage container
- High volume capacity provides up to 4 quarts or 4 liters of colostrum or electrolytes
- Durable and versatile allowing user to freeze colostrum
- Configuration of the bottle provides for easy storage in a freezer compartment, lays on its side or upright
- High value storage cap provides secure interface between cap and container
- Feeder bottle is built to be used in automatic washers as well as used in conventional feeding racks
- Adaptable neck finish available in rollover model (see Calf-Maid® Bottle, 4 Quart / 4 Liter)
- Handle and body are easily cleaned internally using a long handled Bottle Brush (#39805)
- Oral feeder probes available in plastic or stainless steel



Item	Product Description	UOM
39402	HANDI GRIP™ 4 Quart / 4 Liter (Bottle, Ring, Nipple & Storage Cap)	Each
39405	HANDI GRIP™ 4 Quart / 4 Liter (Bottle & Storage Cap)	Each

Note:
Don't forget a **Bottle Brush** for cleaning located on **page 137**.

Calf-Maid® Nipple, Black

- Patented venting system minimizes calf bloating during nursing

Item	Product Description	UOM
39800	Calf-Maid® Nipple, Black	Each

Nipple with Screw Ring

Item	Product Description	UOM
39803	Nipple, Red with Screw Ring for 2 Liter Bottles	Each
39803BK	Nipple, Red with Screw Ring for 3 & 4 Liter Bottles	Each



Adapt-A-Bottle™ Replacement Port Valve & Screw Ring

Item	Product Description	UOM
39503	Adapt-A-Bottle™ Replacement Port Valve & Screw Ring	Each



Storage Caps for 2, 3 & 4 Liter Bottles

Item	Product Description	UOM
06570WH	Cap, White Foam-Lined 70-485 (fits Adapt-A-Bottle™)	Each
06413BK	Cap, Black 70-410 with Expansion Ring (fits 3 & 4 Liter Bottles)	Each
06562BK	Cap, Black VDO 70-410 Double Stepped Barb (fits 3 & 4 Liter Bottles)	Each



MAI Oral Calf Feeder Bag

- Oral feeding system for colostrum, electrolytes and medicated fluids
- Large 2-1/2 liter vinyl bag to hold fluids or electrolytes
- Large zipper for easy filling and cleaning
- Large handle for carrying or hanging
- Available with one-piece plastic probe
- 2 sizes of oral probes; standard and small probes
- Halkey-Roberts® clamp to regulate flow rate

Item	Product Description	UOM
05200	MAI Oral Calf Feeder Bag, 2-1/2 Liter with Plastic Probe	Each
39541	MAI Oral Calf Feeder Bag, 2-1/2 Liter with Small Plastic Probe	Each



Blue Bar™ Calf Mouth Gag

The Blue Bar™ Calf Mouth Gag is for use with calves and other animals weighing 100 lbs or more for routine procedures involving stomach tubes or fiber-optic scopes. The durable mouth gag features a plastic I-beam design for strength with a hole in the center to allow the user to pass a small to medium stomach tube or fiber-optic scope through the oral cavity for lung and rumen / stomach procedures.

Item	Product Description	UOM
39548	Blue Bar™ Calf Mouth Gag	Each



Calf Bottles with Plastic Probe & Vented Plastic Cap

A standard calf bottle adapted to be used for force feeding colostrum fluids.

- Bottle may be used with milk nipple or oral feeder system
- Storage cap allows for storage of fresh or frozen colostrum
- Probe's tapered bulb end inserts easily into patient's esophagus
- One-piece vented cap fits standard milk feeding container with threaded mouth
- Halkey-Roberts® clamp to regulate flow rate
- Barbed probes securely hold tubing
- Includes: bottle, threaded vented cap, tube, clamp, rigid plastic probe and storage cap

Item	Product Description	UOM
05250	Adapt-A-Bottle™ 2 Liter with Plastic Probe & Storage Cap	Each
39501	Adapt-A-Bottle™ 2 Liter with Small Probe & Storage Cap	Each
39510	Adapt-A-Bottle™ 3 Liter with Plastic Probe & Storage Cap	Each
39516	HANDI GRIP™ 4 Quart / 4 Liter with Plastic Probe & Storage Cap	Each
06413BK	Cap, Black 70-410 with Expansion Ring (fits 3 & 4 Liter Bottles)	Each

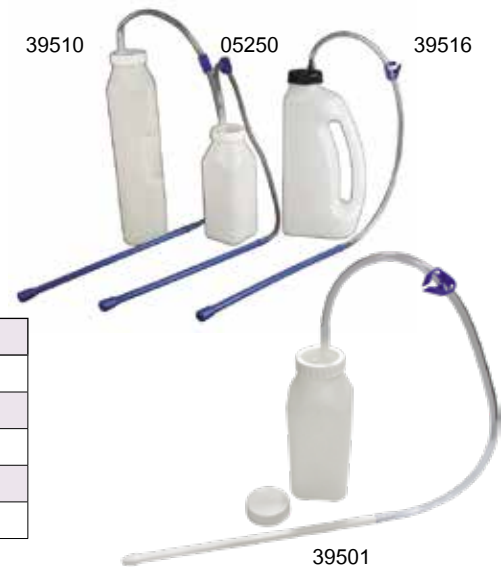

Plastic Probes for 2, 3 & 4 Liter Bottles with Vented Cap

Item	Product Description	UOM
39506	Probe, Plastic with Halkey-Roberts® Clamp for 2 Liter Bottle	Each
39508	Small Probe Assembly, Plastic with Clamp & Cap for 2 Liter Bottle	Each
39509	Small Probe Assembly, Plastic with Clamp & Cap for 3 & 4 Liter Bottles	Each
39410	Probe, Plastic with Halkey-Roberts® Clamp for 3 & 4 Liter Bottles	Each



Stainless Steel Probes for 3 & 4 Liter Bottles with Single Piece Threaded Vented Cap



- Stainless steel probe is barbed to securely hold flexible tubing

Item	Product Description	UOM
39411	Probe, Stainless Steel, 3/8" with Halkey-Roberts® Clamp for 3 & 4 Liter Bottles	Each
39412	Probe, Stainless Steel, 1/2" with Halkey-Roberts® Clamp for 3 & 4 Liter Bottles	Each



Stainless Steel Probes for 2 Liter Bottles with Threaded Vented Cap



Item	Product Description	UOM
39415	Probe, Stainless Steel, 3/8" with Halkey-Roberts® Clamp for 2 Liter Bottle	Each
39416	Probe, Stainless Steel, 1/2" with Halkey-Roberts® Clamp for 2 Liter Bottle	Each



Colostrum Probes



- Fits Genex® & Perfect Udder® Colostrum Bags

Item	Product Description	UOM
39545-1	Probe, Plastic for Colostrum Bag - 20 mm Cap with 1" Tubing Extension	5/Bag
39545-2	Probe, Plastic for Colostrum Bag - 20 mm Cap with 30" Tubing & Halkey-Roberts® Clamp	5/Bag
39547	Probe, Small, Plastic for Colostrum Bag - 20 mm Cap - Direct Thread	5/Bag
39547-1	Probe, Small, Plastic for Colostrum Bag - 20 mm Cap with 1" Tubing Extension	5/Bag
39547-2	Probe, Small, Plastic for Colostrum Bag - 20 mm Cap with 30" Tubing & Halkey-Roberts® Clamp	5/Bag



EMT Large Animal IV Giving Set



- Disposable double spike IV fluid delivery system designed for large animal fluid administration
- Spiked, vented 20 drops/ml drip chamber
- Halkey-Roberts® clamp to regulate flow rate
- Total length with coil extended is 157"
- Roller clamp to adjust drip rate
- Luer lock needle adapter
- Injection port
- Spike securing straps
- Individually packaged and gamma irradiated or ETO exposed
- Single use item

Item	Product Description	UOM
39006	EMT Large Animal IV Giving Set	Each



EMT Small Animal IV Giving Set



- Disposable IV fluid delivery system designed for small animal fluid administration
- Spiked, vented 15 drop/ml drip chamber
- Halkey-Roberts® clamp to regulate flow rate
- Total length with coil extended is 96"
- Roller clamp to adjust drip rate
- Luer lock needle adapter
- Injection port
- Individually packaged and gamma irradiated or ETO exposed
- Single use item

Item	Product Description	UOM
39012	EMT Small Animal IV Giving Set	Each



3-Lead IV Delivery System

Multiple-lead intravenous fluid delivery system used in large animals receiving large volumes of fluids and medicants due to debilitating disease, surgery or other major disorders.

- 3 non-vented spikes
- Luer lock tip at outflow end
- 72" long tubing with drip chamber, controlled by roller clamp
- Individually packaged and EtO exposed
- Primarily used in large animal / equine
- Single use item

Item	Product Description	UOM
05141	3-Lead IV Delivery System	Each



IV Fluid Bags

- Used to administer large volumes of fluid
- Large handle for carrying or hanging
- Flexible 60" long tube
- Drip chamber controlled by roller clamp
- Gamma irradiated or EtO exposed
- Single use item

Item	Product Description	UOM
04550	IV Fluid Bag, 3 Liter with Drip Chamber, 60" Tube & Needle Adapter	Each
04551	IV Fluid Bag, 6 Liter with Drip Chamber, 60" Tube & Needle Adapter	Each



IV Bag Hanger

Item	Product Description	UOM
40805	IV Bag Hanger, Six-Bag Swivel	Each



IV Giving Sets with Drip Chambers

- Large bore
- Luer slip
- Injection port
- 15 drops/ml drip chamber
- Vented spike
- Individually packaged and gamma irradiated or EtO exposed

IV Giving Set with 15 Drop Chamber

- Single use item

Item	Product Description	UOM
39000	IV Giving Set with Drip Chamber, 64"	Each



IV Giving Set with 15 Drop Chamber & Injection Port

- Single use item

Item	Product Description	UOM
39018	IV Giving Set with Drip Chamber & Injection Port, 84"	Each



IV Spike with Tubing

- Vented bottle spike with 60" large bore tubing
- Halkey-Roberts® clamp to regulate flow rate
- Luer slip tip
- Individually packaged and gamma irradiated or EtO exposed
- Single use item

Item	Product Description	UOM
04123	IV Spike with Tubing	Each



Secondary Set with Vented Spike for IV Giving Sets

- Single use item

Item	Product Description	UOM
39002	Secondary Set with Vented Spike for IV Giving Sets, 18"	Each



Extension Set for IV Giving Sets

- Single use item

Item	Product Description	UOM
39001	Extension Set for IV Giving Sets, 18"	Each



Large Bore IV Set

- Luer lock tip
- Large bore spike
- 72" length tubing with drip chamber
- Flow rate for 1 liter bag: 1 minute 10 seconds with 10 gauge needle
- Halkey-Roberts® clamp to regulate flow rate
- Individually packaged and EtO exposed
- Single use item

Item	Product Description	UOM
40200	Large Bore IV Set, Single Line with Drip Chamber	Each



MAI IV Simplex

- Vented device used to administer intravenous solutions and medicants to large animals
- Funnel opening is 2.6 cm inside diameter that stretches to fit over most common bottle neck finishes
- 72" star design tubing, minimizes kinking
- Used in IV fluid therapy
- Funnel made of plastisol versus latex rubber
- Luer slip needle adapter
- Halkey-Roberts® clamp to regulate flow rate
- Quick Tip™ IV Simplex Adapter is included
- Single use item

Item	Product Description	UOM
04127	MAI IV Simplex with Luer Slip Needle Adapter	Each



Quick Tip™ IV Simplex Adapter

- Quickly transfers a Simplex from bottle to bottle
- No interruption of fluid delivery
- Adapts to any bottle with a 28 mm to 33 mm neck finish
- Attaches to either latex rubber or plastic funnel of a Simplex assembly
- Less stress on animals
- Reduces frustration by users
- Patent pending globally
- Single use item



Note:
Quick Tip™ IV Simplex Adapter is ideal for use with the **MAI IV Simplex** or may be used with ANY manufacturer's Simplex!

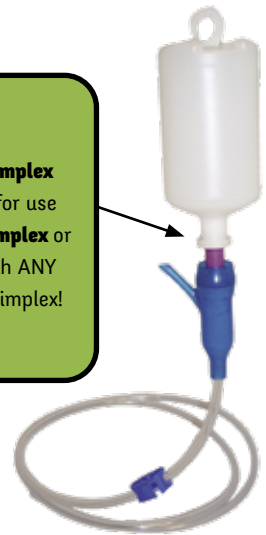

Item	Product Description	UOM
40409	Quick Tip™ IV Simplex Adapter with Header Card	3/Bag
40410	Quick Tip™ IV Simplex Adapter	10/Bag
40411	Quick Tip™ IV Simplex Adapter - Bulk	1,000/Box

Quick Tip™ IV Simplex

Fits the inner diameter of fluid bottles instead of over the bottle's outer lip, making for easy and efficient transfer of the IV Simplex from bottle to bottle.

- Simple, versatile, quick and easy to use
- Reduces frustration by users
- Adapts to any serum bottle size from 28 mm to 33 mm neck finish
- Specialized adapter fits most 28 mm bottle neck finishes
- Designed and developed by a dairy farmer
- Threaded Cap Adapter included
- Single use item

Item	Product Description	UOM
40415	Quick Tip™ IV Simplex Set with 28 mm Threaded Cap Adapter	Each
06404BL	28-410 Threaded Cap Adapter	Each

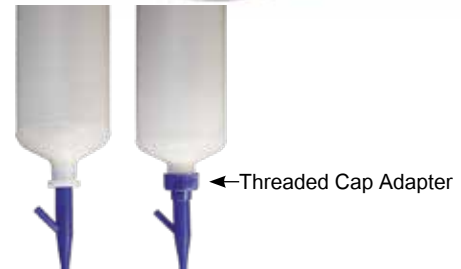

Jug Pumps

- Quick, efficient method of pressurizing a bottle or bag for rapid input of liquids
- Can be used for therapeutic flushing or infusion
- Control valve allows release of pressure without disconnecting bulb or tubing
- Available with or without drip chamber
- Luer slip needle adapter
- Single use item

Item	Product Description	UOM
05145	Jug Pump with Spiked Drip Chamber	Each
05148	Jug Pump without Drip Chamber	Each



Needle Adapter & Cap

- Single use item

Item	Product Description	UOM
04126	Needle Adapter & Cap	12/Bag



Enema Zip Top Bag with Foal Tip

- Critical care fluid delivery system
- System also used for uterine therapeutic procedures
- Graduated 2-1/2 liter PVC bag with zip top closure
- Fluid exit port located at the base of bag
- Probe has a uniquely designed tip which may be used orally or for a high volume enema
- Large diameter tubing for rapid flow with attached enema tip
- Plastic handle for holding or hanging
- Halkey-Roberts® clamp to regulate flow rate



Item	Product Description	UOM
05215	Enema Zip Top Bag with Foal Tip, 2-1/2 Liter	Each

Dr. Larson's™ Frost Free™ Plus

- Topical skin conditioner used in prevention of frozen teats
- Contains emollients preventing teat irritation caused by freezing, sun burn or other environmental conditions
- Assists in preventing chapping or irritation due to pre and post dip sanitizers
- Soothes, protects and maintains teats' smooth and supple characteristics
- Easy to apply and lasts from milking to milking
- Use selectively or apply to entire herd
- Cost effective to use year round
- Convenient sizes to meet herd needs
- Works synergistically with teat dilators to promote healing of the teats external orifice while the dilator keeps the teat canal open and functional until it heals



Item	Product Description	UOM
33500	Dr. Larson's™ Frost Free™ Plus, 1 lb Jar	Each
33510	Dr. Larson's™ Frost Free™ Plus, 4 lb Jar	Each
33520	Dr. Larson's™ Frost Free™ Plus, 8 lb Pail	Each
33530	Dr. Larson's™ Frost Free™ Plus, 32 lb Pail	Each

Dr. Larson's™ Derma-Mint™

Contains menthol, well known for its cooling, antiseptic, analgesic and anti-inflammatory effects. Peppermint oil has long been recognized for its diverse medicinal properties.

- 35% all natural peppermint oil, non-greasy formulation
- Helps improve teat and udder health
- An aid to maintain udder condition post freshening
- Increases circulation and reduces swelling
- Apply 5 ml - 10 ml two to three times a day for 3 days
- Also effective on swollen hocks or joints
- Mild, safe and worry free
- Do not rub into open wounds or teat sphincter
- Contains no antibiotics
- Convenient hanging hook
- Designed for use in organic production*



Item	Product Description	UOM
42001	Dr. Larson's™ Derma-Mint™, 500 ml	Each

*Standards for organic may vary. Check for local approval.



Dr. Larson's™ Derma Manage-Mint™ & Derma Mist™



- Unique formulation of peppermint, tea tree and calendula plant oils that soften and condition tender udders after calving
- Available as a cream (Derma Manage-Mint™) and as a spray (Derma Mist™)
- Reduces udder edema that can damage mammary supportive ligaments and shorten milking longevity
- Relieves udder edema allowing for better milk letdown and easier milking unit attachment
- Safe and completely natural herbal products
- Dairymen report treatment with plant oil products can reduce somatic cell counts
- Blue spray maintains bright blue color on udder, yellow spray dries clear
- No meat or milk residues
- Designed for use in organic production*

Item	Product Description	UOM
42010	Dr. Larson's™ Derma Manage-Mint™, 500 ml	Each
42012	Dr. Larson's™ Derma Mist™ Yellow, 500 ml Spray Bottle	Each
42014	Dr. Larson's™ Derma Mist™ Blue, 500 ml Spray Bottle	Each



Genesis Infusion Cannula



Blunt end cannula used to medicate teats or difficult to reach orifices.

- Standard teat cannula with a tapered tip for ease of insertion
- Attaches to luer lock or luer slip syringe tip
- Individually packaged
- Single use item

Item	Product Description	UOM
02115	Genesis Infusion Cannula	100/Box



Genesis Teat Dilator



Uniquely designed with diamond-shaped wings to hold the dilator securely in position without causing irritation to the teat sphincter.

- Made of soft flexible plastic
- Broad base prevents over insertion allowing teat sphincter to relax
- Non-traumatic and non-irritating
- Does not cause scarring
- Individually packaged
- Single use item

Item	Product Description	UOM
17125	Genesis Teat Dilator	100/Box



Scott™ Nozzle



- Unique short tipped plastic cannula
- Provides complete treatment of entire teat with partial insertion of tip into teat canal
- Used for intramammary injection of medicine for dry cow treatment and mastitis
- Attaches to luer lock or luer slip syringe tip
- Individually packaged
- Single use item

Item	Product Description	UOM
02118	Scott™ Nozzle	100/Box



Shyr™ Teat Tube with Cap

Capped infusion teat tube used for medicating mammary glands.

- Allows user to place teat tube onto a syringe without contaminating the tip
- Once attached to syringe, remove protective cap and insert teat tube to administer medicant
- Attaches to a luer lock or luer slip syringe tip
- Individually packaged
- Single use item



Item	Product Description	UOM
02515	Shyr™ Teat Tube with Cap	100/Box

Dr. Larson's™ Teat Tubes

- Flexible, non-irritating fingers to retain tube in teat
- Teat sphincter is immobilized to aid healing, even with badly injured teats
- Leave in teat until teat orifice is healed
- Removing threaded cap allows milk to drain
- Individually packaged and gamma irradiated
- Available 3 per bag or 36 per display card
- Single use item



Item	Product Description	UOM
02528	Dr. Larson's™ Teat Tubes	3/Bag
02530	Dr. Larson's™ Teat Tubes with Display Card	36/Card

Shyr™ Milk Tubes

- Indwelling milk tube with superior design
- Friction base allows for medicant administration without removal
- Base fits all mastitis tubes and luer slip syringe tips
- Cap is permanently attached
- Lightweight plastic construction, 1/18 the weight of steel tubes
- Flexible, trauma free
- Individually packaged, 50 per display card
- Available in 2 sizes; small and large
- Single use item



Item	Product Description	UOM
02550	Shyr™ Milk Tubes, 1-3/4" x 1/16" Small with Display Card	50/Card
02555	Shyr™ Milk Tubes, 1-3/4" x 1/8" Large with Display Card	50/Card

Stainless Steel Teat Sphincter Dilator

Tapered stainless steel instrument.

- Used to stretch a constricted teat sphincter
- Less trauma to teat
- Stretching action reduces muscular striction
- Autoclavable or easily sanitized



Item	Product Description	UOM
42400	Stainless Steel Teat Sphincter Dilator	Each



High Speed Stainless Steel Spiral Teat Curette Set

High speed stainless steel, spiral cutting edge instrument used to remove scar tissue and debris from traumatized teat sphincter.

- Curette set includes one small and one large diameter instrument
- Cutting edge in spiral configuration
- Assists in removal of foreign tissue
- Autoclavable or easily sanitized

Item	Product Description	UOM
42403	High Speed Stainless Steel Spiral Teat Curette Set, Set of 2	Each



Handi-Dipper™ **PATENTED**

The easy and simple method for dipping newborn's umbilical cord.

- Non-return cup allows use on single animal; solution remaining in cup is discarded
- Reduces the potential for contaminated iodine
- Improved husbandry methods
- Squeezable bottle and tube deliver a maximum of 30 ml, filling cap without splashing
- Attached hook allows easy hanging
- 400 ml capacity, low density polyethylene bottle

Item	Product Description	UOM
42610	Handi-Dipper™	Each



CLIP-ITS™

Provide a visual reminder to ensure patient care instructions are not overlooked.

See pages 171-173





Wild Child™ Chambers

The Wild Child™ and the Wild Child™ II Chambers are professional management tools used to assist veterinarians and staff in handling fractious cats and other companion animals safely and humanely. Made of clear, durable polycarbonate which allows veterinarians and staff ability to view the secured patient during procedures. Provides clinic staff a proven method in handling patients, reducing potential trauma to patient and staff. Can be cleaned with most antiseptics (unlike acrylic chambers). An essential tool in any veterinary clinic.

Wild Child™

Easily transfer animal from cage to chamber without physically touching the patient. Unique design, including a clear lid with a handle and horse shoe security bar which adjusts to four different levels of restraint and convenient access holes for injections.

Item	Product Description	UOM
55220	Wild Child™ Chamber - 17" H x 10-1/2" W x 8" L	Each
55221	Wild Child™ Lid	Each
55222	Wild Child™ Stainless Steel Bar	Each



Wild Child™ II

The ultimate management tool with a concave bottom to restrict movement of the animal and allows for easy cleaning. Easy-to-use lid and cam latch design allows adjustment to three different levels and locks into place by simply turning the handle.

Item	Product Description	UOM
55230	Wild Child™ II Chamber - 16" H x 10" W x 8" L	Each
55231	Wild Child™ II Lid	Each



Shot Shield™



The Shot Shield™ is made of durable clear polycarbonate designed to put a barrier between you and the patient. It allows the user to suppress the patient while giving injections or attempting to secure the patient for procedures.

- Measures 12" x 16"

Item	Product Description	UOM
55900	Shot Shield™	Each



Small Animal Head Snare



- Strong stainless steel loop coated with smooth plastic to assure atraumatic use on patients
- May be sterilized with ethylene oxide or placed in an antiseptic solution
- Ideal for retrieval of cats and small dogs from kennels
- Can be used for lambings or farrowings
- Convenient and easy to use

Item	Product Description	UOM
57500	Small Animal Head Snare	Each



Extend-A-Pole Snares



- Ideal for capturing and helping to restrain difficult animals
- Constructed of sturdy polyethylene coated cable attached to a two-piece aluminum pole
- 1/4 twist of the pole locks snare in place, simply reverse to release

Item	Product Description	UOM
57503	Extend-A-Pole Snare, 2' to 4'	Each
57505	Extend-A-Pole Snare, 4' to 6'	Each



Nylon Muzzles



Made of heavy duty nylon with quick release snap on an adjustable strap. Lightweight, soft and flexible yet strong and durable.

Item	Product Description	UOM
57310	Nylon Safety Muzzles, Set of 6	Each
57311	Nylon Safety Muzzle, #1	Each
57312	Nylon Safety Muzzle, #2	Each
57313	Nylon Safety Muzzle, #3	Each
57314	Nylon Safety Muzzle, #4	Each
57315	Nylon Safety Muzzle, #5	Each
57316	Nylon Safety Muzzle, #6	Each



Muzzle Sizes:

- #1 - Fits toy breeds such as Chihuahuas, Pomeranians or Silky Terriers
- #2 - Fits small breeds such as Miniature Poodles, Shelties or Dachshunds
- #3 - Fits breeds the size of Cocker Spaniels, Miniature Schnauzers, Wire Fox Terriers or Cock-A-Poos
- #4 - Fits breeds the size of Dobermans, standard Schnauzers or small Setters
- #5 - Fits breeds the size of Shepards, Labradors or Boxers
- #6 - Fits large breeds such as Saint Bernards, Old English Sheep Dogs, Akitas or Great Danes

Premium Leather Muzzles



Made of high quality riveted leather. Elongated strap is riveted to muzzle with quality buckle for easy adjustment.

Item	Product Description	UOM
27400	Premium Leather Muzzles, Set of 5	Each
27401	Premium Leather Muzzle, #1	Each
27402	Premium Leather Muzzle, #2	Each
27403	Premium Leather Muzzle, #3	Each
27404	Premium Leather Muzzle, #4	Each
27405	Premium Leather Muzzle, #5	Each



Safety Leather Muzzles



Made of high quality leather. Muzzle face is one-piece construction with interlock rivets. The strap is a pull through design riveted to itself. Also available in black leather.

Item	Product Description	UOM
27430	Safety Leather Muzzles, Set of 6	Each
27431	Safety Leather Muzzle, #1	Each
27432	Safety Leather Muzzle, #2	Each
27433	Safety Leather Muzzle, #3	Each
27434	Safety Leather Muzzle, #4	Each
27435	Safety Leather Muzzle, #5	Each
27436	Safety Leather Muzzle, #6	Each



Leather "X" Strap Muzzles

Item	Product Description	UOM
27450	Leather "X" Strap Muzzles, Set of 6	Each
27451	Leather "X" Strap Muzzle, #1	Each
27452	Leather "X" Strap Muzzle, #2	Each
27453	Leather "X" Strap Muzzle, #3	Each
27454	Leather "X" Strap Muzzle, #4	Each
27455	Leather "X" Strap Muzzle, #5	Each
27456	Leather "X" Strap Muzzle, #6	Each



Feline / Brachy Muzzle

- For control of unruly cats and brachycephalic dogs
- Made of soft, pliable leather

Item	Product Description	UOM
27420	Feline / Brachy Muzzle	Each
57320	Nylon Feline / Brachy Muzzle	Each



Gotcha™ Muzzle Handles

Simple, easy to use muzzling aid for aggressive dogs. Protects your fingers, hands and arms! Reversible; enables the user to approach patient from either the front or behind. Handle extensions measure 30" in length. Economical and easy to clean.

Item	Product Description	UOM
57300	Gotcha™ Muzzle Handles, Kit	Each
57301	Gotcha™ Muzzle Handles, Handles	Each
57302	Gotcha™ Muzzle Handles, Muzzles	Each



SIGNAGE

Engraved Business Signs provide clients with critical details and clinic policies.

See pages
174-178



Rectal Rings & Accessories

A non-surgical method of correcting a prolapsed rectum in swine, sheep and cattle. Elastorator bands are applied over the prolapse area onto the plastic rectal ring or probe, preplaced and oriented at the base of the anus. Grooved area of the probe is at the anal sphincter base inside the anal lumen. The elastorator band is released onto the groove, sealing tightly and securely onto the exposed rectal tissue at the base of the anus. Pressure necrosis causes the exposed tissue to fall off after 10 to 14 days due to lack of blood supply.

- Single use item

Item	Product Description	UOM
43001	Rectal Rings, 1/2"	20/Bag
43002	Rectal Rings, 5/8"	20/Bag
43003	Rectal Rings, 3/4"	20/Bag
43004	Rectal Rings, 7/8"	10/Bag
43005	Rectal Rings, 1"	10/Bag
43006	Rectal Rings, 1-1/4"	10/Bag
43011	Rectal Rings, 1/2" Bulk	1,000/Box
43012	Rectal Rings, 5/8" Bulk	1,000/Box
43013	Rectal Rings, 3/4" Bulk	1,000/Box
43014	Rectal Rings, 7/8" Bulk	1,000/Box
43015	Rectal Rings, 1" Bulk	1,000/Box
43016	Rectal Rings, 1-1/4" Bulk	1,000/Box
43800	Elastorator Band Applicator	Each
43803	Elastorator Band for Rectal Rings	100/Bag



Umbilical Clamps

- Used to seal the umbilicus of newborns to reduce exposure to the environment and to prevent disease infiltration
- Enhances the umbilicus' healing process and reduces the potential for umbilical hernias
- Designed to be applied with the Umbilical Clamp Applicator to assure secure closure
- Single use item

Item	Product Description	UOM
14500	Umbilical Clamp Applicator	Each
14502	Umbilical Clamp, Puppy	25/Bag
14505	Umbilical Clamp, Pig / Sheep	25/Bag
14510	Umbilical Clamp, Calf / Foal	10/Bag



Halkey-Roberts® Clamp

Item	Product Description	UOM
04816	Halkey-Roberts® Clamp	Each



Dr. Larson's™ Dehorning Paste

- Apply to inhibit horn growth before it starts
- Safer and less invasive than dehorning saws and gouging dehorner
- Specialty tip allows precise application of the paste onto horn bud
- Syringe applicator minimizes exposure of user to dehorning paste
- Multi-Dose™ Syringe applicator applies a consistent, uniform amount with little waste
- Easy to administer
- Dehorns approximately 24 calves per tube
- Recommended for calves 1 to 7 days old
- Horn-Check Paste is available in the UK and New Zealand markets



Item	Product Description	UOM
34200	Dr. Larson's™ Dehorning Paste, 32 cc Multi-Dose™ Syringe	12/Box
34200-1	Dr. Larson's™ Horn-Check Paste, 32 cc Multi-Dose™ Syringe (UK Market)	12/Box
34200-2	Dr. Larson's™ Horn-Check Paste, 32 cc Multi-Dose™ Syringe (NZ Market)	12/Box

Indwelling Bloat Whistle

Three-piece plastic device to aid in chronic bloat relief.

- Inexpensive, rapid and simple procedure to correct bloat
- Placed into rumen using a minor surgical procedure where the trochar wings secure the rumen in place against the peritoneum. The outer trochar collar holds the trochar in place from the exterior via attachment tabs
- Single use item



Item	Product Description	UOM
14010	Indwelling Bloat Whistle	6/Box

Hylton LDA Repair Kit

Complete kit to relocate and repair a displaced abomasum.

- Roll and tack method
- Kit includes: Trochar, 2 Probes, 10 Toggle Pins with #5 Suture and 10 Buttons
- Trochar is used to pierce the abomasum
- Toggle Pin is a nylon rod with #5 Suture
- Probe is used to force Toggle Pin through Trochar for placement in abomasum
- Toggle Pin is placed in the abomasum and suture is secured to a Button after Trochar is removed
- Button retains Toggle Pin in place once sutured
- Kit may also be used in correcting a prolapsed vagina in beef or dairy cows



Item	Product Description	UOM
42700	Hylton LDA Repair Kit	Each
42710	Trochar for LDA Repair Kit	Each
42715	Buttons for LDA Repair Kit	10/Bag
42719	Toggle Pins without Suture for LDA Repair Kit	10/Bag
42720	Toggle Pins with Suture for LDA Repair Kit	10/Bag
42730	Probes for LDA Repair Kit	2/Bag



MAI Fecal Loops

All plastic, disposable instrument used primarily in small animals to retrieve stool specimens for fecal flotation procedures.

- Tapered loop provides easy insertion for fecal collection
- Soft, flexible plastic loops
- Single use item

Item	Product Description	UOM
19263	MAI Fecal Loop, Large	10/Bag
19264	MAI Fecal Loop, Small	10/Bag



MAI Fecal Flotation Kit

- Flotation media will not spill if unit is over filled, due to unique reservoir system
- Attached spatula is broken off the screen and used to place sample into specimen jar
- Capped jar with spatula inside may be sent home with clients to return a stool sample
- Crack and peel label for specimen jar identification
- Single use item

Item	Product Description	UOM
19260	MAI Fecal Flotation Kit	100/Box



Fecal Flotation Kit Accessories

- Modified Wisconsin Fecal Parasite Egg Flotation Starter Kit is designed for processing a large number of fecal exams in a parasite detection and control program
- Starter Kit includes: reagent, materials and instructions to run 100 tests

Item	Product Description	UOM
49700	Modified Wisconsin Fecal Parasite Egg Flotation Starter Kit, 100 Tests	Each
49701	Modified Wisconsin Fecal Parasite Egg Flotation Replacement Kit, 72 Tests	Each
49702	Fecal Flotation Sucrose Solution Dispenser	Each
49705	Fecal Flotation Reagent, 1,000 ml Bottle (50 Test Size)	Each
49706	Fecal Flotation Reagent, 4,000 ml Bottle (200 Test Size)	Each
49715	Fecal Parasite Sample Cups, 250 ml	10/Box



49700

Urine Kit & Fecal Baggies

To encourage compliance with specimen requests.

- Simple and easy kits for obtaining specimen samples
- Single use item

Urine Kit

Item	Product Description	UOM
49730	Urine Kit with Sponge on Card	100/Pkg



Fecal Baggies

Item	Product Description	UOM
49720	Fecal Baggie - 3" x 3"	1,000/Pkg
49721	Fecal Baggie with Wooden Spoon	100/Pkg
49722	Fecal Baggie with Wooden Spoon on Card	100/Pkg
49723	Fecal Baggie on Card Only	100/Pkg



MAI Feline Non-absorbable Litter & Trays

- Non-absorbable litter allows urine to settle into the plastic tray
- Specialty non-absorbable beads are treated to prevent any adhering of voided urine and urine composition including proteins, red blood cells, crystals or other potentially diagnostic materials
- Litter can be filtered permitting easy collection of a urine specimen
- Cats are attracted to the litter and will generally find the litter acceptable for the feline "scratch" factor
- Ideal for use post-surgically or after declawing
- Easy to dispense to clients
- Litter can be cleaned and reused
- Low cost and effective

Kit includes:

- 10 pounds of litter
- 10 plastic trays



Item	Product Description	UOM
19270	MAI Feline Non-absorbable Litter & Tray Kit, 10 lbs Litter & 10 Trays	10/Box
19275	MAI Feline Non-absorbable Litter, 10 lb Bag	Each
50000	MAI Feline Non-absorbable Litter, 5 lb Jug	Each
19271	Feline Litter Tray	10/Box
19272	Feline Litter Tray, Bulk	250/Box

Uri-Void™ Feline Urine Collection Kit

- Specialty non-absorbable beads are treated to prevent any adhering of voided urine and urine composition including proteins, red blood cells, crystals or other potentially diagnostic materials
- Uses the "pipette method" of urine collection
- Ideal for dispensing to clients for at-home use

Kit includes:

- Uri-Tray™ collection tray
- Litter in Uri-Seal™ container
- Uri-Pette™ sampling pipette with cap
- Urine collection label for identification



Item	Product Description	UOM
50188	Uri-Void™ Feline Urine Collection Kit	12/Box

Quick Draw™ Feline Urine Collection Kit

Method of collecting urine samples, even when a small volume of urine is voided.

- Reliable samples without contamination of hands
- Clean, quick and easy to use
- May be used for sampling of other body fluids
- Kit may be used in conjunction with MAI Feline Non-absorbable Litter

Kit includes:

- Absorbent sponge (absorbs 3 cc of liquid) attached to a flexible handle
- 45 cc container
- Identification label



Item	Product Description	UOM
19280	Quick Draw™ Feline Urine Collection Kit	48/Box



Endoscopic Aspiration Kits

Designed to allow collection of cytology samples by aspiration of fluids through the biopsy channel of flexible fiber-optic endoscope.

- Thin-wall plastic tube with a luer connector at proximal end
- Stainless steel stylet used to assist in passage through the biopsy channel
- Approximately 35 cm longer than channel length
- Individually packaged and gamma irradiated or ETO exposed
- Single use item

Item	Product Description	UOM
64842	Endoscopic Aspiration Kit - 70 cm (for use with Scopes having a 1.8 mm Diameter Channel, 70 cm Length)	Each
64840	Endoscopic Aspiration Kit - 80 cm (for use with Scopes having a 2.0 mm Diameter Channel, 80 cm Length)	Each
64845	Endoscopic Aspiration Kit - 1.1 M (for use with Scopes having a 2.0 mm Diameter Channel, 1.1 M Length)	Each
64830	Endoscopic Aspiration Kit - 1.4 M (for use with Scopes having a 2.0 mm Diameter Channel, 1.4 M Length)	Each
64835	Endoscopic Aspiration Kit - 1.7 M (for use with Scopes having a 2.0 mm Diameter Channel, 1.7 M Length)	Each
64838	Endoscopic Aspiration Kit - 2.5 M (for use with Scopes having a 2.0 mm Diameter Channel, 2.5 M Length)	Each



Note:
Endoscopic Aspiration Kits may be used with the Endoscopes found on pages 111-117.

Endoscopic Culture Swabs

Endoscopic swabs use an endoscope's lumen channel in completing the procedure of swabbing potentially infected areas examined with an endoscope. Secured samples are transferred onto culture media or used in other diagnostic procedures. Swab's selection is based upon the endoscope length used by the practitioner.

- Designed to allow culturing through the biopsy channel
- Outer guarded tube helps protect the central swab from contamination upon insertion
- Distal end of tube has a water-soluble plug which is removed before taking the sample
- Calcium alginate swabs are attached to a stainless steel wire
- Calcium alginate fiber head for low pathogen toxicity
- Swab length easily reduced, with forceps provided, for transport after taking culture
- Individually packaged and gamma irradiated or ETO exposed
- Single use item

Item	Product Description	UOM
64855	Endoscopic Culture Swab - 1.1 M (for use with Scopes having a 2.0 mm Diameter Channel, 1.1 M Length)	Each
64850	Endoscopic Culture Swab - 1.4 M (for use with Scopes having a 2.6 mm Diameter Channel, 1.4 M Length)	Each
64852	Endoscopic Culture Swab - 1.7 M (for use with Scopes having a 2.6 mm Diameter Channel, 1.7 M Length)	Each
64853	Endoscopic Culture Swab - 2.4 M (for use with Scopes having a 2.6 mm Diameter Channel, 2.4 M Length)	Each
45425	Endoscopic Culture Swab - 3.3 M (for use with Scopes having a 2.6 mm Diameter Channel, 3.3 M Length)	Each
45427	Endoscopic Culture Swab - 3.8 M (for use with Scopes having a 2.6 mm Diameter Channel, 3.8 M Length)	Each



Tracheal Wash Kits

Procedural kit used to flush or wash the trachea of any animal with primary emphasis on equine. Method may be used diagnostically or therapeutically. Choice of semi-flexible or stiff catheter.

Tracheal Wash Kit with Semi-Flexible Catheter

- Suitable for both foals and mature horses
- Semi-flexible catheter with luer connector
- Sample vial
- Disposable gloves in a peel pouch
- Stainless steel introducer has 14 gauge blunt-end cannula with 16 gauge trochar catheter with wire stylet
- Catheter is 15 gauge, 24"
- Individually packaged and gamma irradiated or EtO exposed
- Single use item

Item	Product Description	UOM
64900	Tracheal Wash Kit with Semi-Flexible Catheter	Each



Tracheal Wash Kit with Stiff Catheter

- Ideal for use on mature horses
- Stiff catheter with luer connector
- Sample vial
- Disposable gloves in a peel pouch
- Stainless steel introducer has 13 gauge blunt-end cannula with 15 gauge trochar catheter
- Catheter is 14 gauge, 24"
- Individually packaged and gamma irradiated or EtO exposed
- Single use item

Item	Product Description	UOM
64905	Tracheal Wash Kit with Stiff Catheter	Each



Nasopharyngeal Swab

- Guarded 12" nasal swab
- Calcium alginate fiber head for low pathogen toxicity
- Rigid outer casing protects swab maintaining secure sealed package
- Individually packaged and gamma irradiated or EtO exposed
- Single use item

Item	Product Description	UOM
45200	Nasopharyngeal Swab	25/Bag



CentriVet™ Blood Glucose & Ketone Meter

Calibrated for Canine, Feline and Bovine

- Small 0.8 µL and 1.2 µL sample size for glucose and ketones
- 5 seconds for glucose results and 10 seconds for ketone results
- Clinically proven accuracy
- Audible fill detection reduces wasted strips
- User friendly design
- Large display with bold numbers
- Strip port faces the animal
- Convenient test strip ejector reduces risk of contamination



Item	Product Description	UOM
49200	CentriVet™ Blood Glucose & Ketone Meter	Each
49206	CentriVet™ Ketone Control Solution, 2 ml Vial	2/Pack
49207	CentriVet™ Glucose Control Solution, 2 ml Vial	2/Pack
49209	CentriVet™ Canine / Feline Blood Ketone Test Strips	25/Pack
49208	CentriVet™ Canine / Feline Blood Glucose Test Strips	50/Pack

OtoKleen™ Ear Cleansing Solution for Dogs & Cats

OtoKleen™ is designed as a non-irritating surface cleaner to lift ear canal dirt and debris from the skin surface and removed via the vacuum action of the Auri-Kleen™ Irrigation / Aspiration Machine.

- Powerful wax dissolver
- Non-irritating formula
- Can be used with the Auri-Kleen™ Irrigation / Aspiration Machine
- Clean several ears with one bottle



Item	Product Description	UOM
48103	OtoKleen™ Ear Cleansing Solution for Dogs & Cats - 16 oz	Each

OtoKleen™ Ear Cleaning Cannulas

The disposable cannulas are very flexible with side ports to use in the ear canal to pulse along the side walls of the ear. By using the flexible tube which luer locks onto the Auri-Kleen™ system, the user is assured of proper cleansing of a patient's ears.

- Single use item

Item	Product Description	UOM
48104	OtoKleen™ Ear Cleaning Cannulas, Small 5FR	10/Bag
48101	OtoKleen™ Ear Cleaning Cannulas, Small 8FR	10/Bag
48102	OtoKleen™ Ear Cleaning Cannulas, Large 12FR	10/Bag



20 Diopter Aspheric Lens

The 20 Diopter Aspheric Lens combines all the necessary features into one durable and high quality unit. The high density plastic lens and coating are scratch-resistant and drop-resistant. The large diameter (2") provides a greater field of view for examinations. A velour storage pouch protects the lens when not in use.

Item	Product Description	UOM
48430	20 Diopter Aspheric Lens	Each



Surgical Loupes

A high quality affordable set of Surgical Loupes with 2.5X magnification and 19" working distance. Surgical Loupes are ideal for dental and surgical procedures. Adjustable inter-ocular barrels allow for multiple users.

Kit includes:

- Loupes
- Head strap
- Safety frames
- Tool kit for adjustments
- Carrying case



Item	Product Description	UOM
48320	Surgical Loupes, 2.5X	Each

LED Clip Light for Surgical Loupes

- 100 lumens of bright white light
- 100,000 hour LED life expectancy
- Operates on 3 "AAA" batteries (included)



Item	Product Description	UOM
48315	LED Clip Light for Surgical Loupes	Each
48314	Power Cord, 10" with 110-Volt Transformer & Switch for #48315 Clip Light	Each



48315

5-Watt LED Headlight

- Extra-bright white, 5-Watt LED
- 300 lumens of LED light for 100,000 working hours
- Fully adjustable headband and overhead strap
- Adjustable light spot size, brightness and position
- 2 rechargeable batteries with charger
- Optional: Compatible with 2.5X Surgical Loupes



Item	Product Description	UOM
48312	5-Watt LED Headlight with 2 Rechargeable Batteries	Each
48322	2.5X Magnification Surgical Loupes for 5-Watt LED Headlight	Each



48322



EEZY-View™ LED Rechargeable Headlight



- Long-lasting high power LED, 1000 lumens
- Four brightness modes
- Soft-touch switch to change light modes
- Continuous working for over 3.5 hours
- Fully adjustable and comfortable headband
- LED housing pivot mount
- Battery mounting tabs and bracket

Item #53840 includes:

- 2 removable, rechargeable Li-Ion battery packs
- Wall charger

Item #53844 Upgrade Kit for 53422 Dual LED Headlight:

- For versions with latest Nose and Battery Mounting Bracket
- Please contact for more information



Item	Product Description	UOM
53840	EEZY-View™ LED Rechargeable Headlight	Each
53841	EEZY-View™ Replacement SG LED Light Kit	Each
53842	EEZY-View™ Replacement SG LED Rechargeable Battery	Each
53843	EEZY-View™ Replacement SG LED Charger	Each
53844	EEZY-View™ SG LED Rechargeable Headlight Upgrade Kit	Each

Single LED Headlights MDS-VET™

The Single LED Headlight is a battery-powered LED headlight with 100,000 hour LED (light emitting diode) for surgical procedures or general examination. Two-way headband adjustment on this lightweight headlight makes it the ideal portable lighting solution.

- Overhead strap for comfort
- Adjustable headband
- Adjustable light position
- 100 lumens of bright white light
- Operates on 3 “AAA” batteries (#48305) (included) or “AA” batteries and 110-Volt transformer (#48316) (included)
- Optional, interchangeable lenses available

Item	Product Description	UOM
48305	Single LED Headlight	Each
48316	Single LED Headlight with “AA” Battery Pack & Transformer	Each



LED Headlight



- Long-lasting high power LED, 1000 lumens
- Four brightness modes
- Soft-touch switch to change light modes
- Continuous working for over 3.5 hours
- Fully adjustable and comfortable headband
- LED housing pivot mount
- Battery mounting hook and loop straps

Includes:

- 2 removable, rechargeable Li-Ion battery packs
- Wall charger

Item	Product Description	UOM
53440	LED Headlight	Each



Clip-On Magnifying Lenses MDS-VET™

The Clip-On Magnifying Lenses for use with #48305 and #48316 provide 1.5X to 2.75X magnification. The “floating” lens creates a comfortable, open configuration compared to standard magnifiers.

Item	Product Description	UOM
48350	Clip-On Magnifying Lens, 1.5X - 20"	Each
48351	Clip-On Magnifying Lens, 1.75X - 14"	Each
48353	Clip-On Magnifying Lens, 2.25X - 8"	Each
48354	Clip-On Magnifying Lens, 2.75X - 6"	Each



DON'T FORGET ABOUT SUTURES.

See pages 101-109

Portable Woods Lamp MDS-VET™

Simply scan the skin surface for any diseased tissues. The long UV wavelength will fluoresce the affected areas. The Portable Woods Lamp is also a flashlight for use in the office or in the field.

- Operates on 4 “AA” batteries (included)

Item	Product Description	UOM
48333	Portable Woods Lamp	Each



Laryngoscope Kit MDS-VET™

The MDS-Vet™ Veterinary Laryngoscope offers high quality stainless steel construction and LED lighting for intubation procedures. The Miller, American profile blades (conventional) (sizes 0-3) are suitable for use with a range of patients.

Includes:

- Miller, American profile blades (conventional), sizes 0-3
- Battery handle with 2 “C” batteries
- LED bulbs
- Carrying / storage case

Item	Product Description	UOM
48437	Laryngoscope Kit with 4 Blades	Each



Battery-Powered Cautery Kit MDS-VET™

The Battery-Powered Cautery Kit is convenient and portable for cauterizing bleeders, removing skin tags or accomplishing many other tasks normally requiring an electro-cautery setup. At 2,200 degrees Fahrenheit, the kit is also useful in trimming beaks and nails on smaller patients and exotic animals.

Kit includes:

- Fine Tip
- Fine Tip, 4"
- Fine Tip (Loop)
- 2 "AA" batteries
- Carrying / storage case

Item	Product Description	UOM
48420	Battery-Powered Cautery Kit	Each

Replacement Tips

48421	Fine Tip	Each
48422	Fine Tip (Loop)	Each
48423	HD Tip, .018"	Each
48424	Fine Tip, 4"	Each
48426	Fine Tip, 6"	Each



Watson Twitch

The Watson Twitch does not work on the principle of pain. Instead, the application of the Watson Twitch to the horse's upper lip causes nerves to release endorphins causing a natural calming agent. The instrument is unique and simple to use.

- Stainless steel construction
- Vinyl covered tips and handles
- Diverts the horse's attention from pain caused elsewhere during the course of treatment

Item	Product Description	UOM
17400	Watson Twitch	Each
45010	Watson Twitch Ring	Each



See our **ENDOSCOPY PRODUCTS**



on pages 117-124



Bellow Wound Irrigation / Drain System

A unique system allows continuous irrigation of wounds that are difficult to drain and maintain.

- System includes a placement needle attached to a fenestrated drain tube with a luer adapter and a 30 cc bellow which easily attaches to luer adapter
- Simple to use
- Designed for use in small and large animals



Item	Product Description	UOM
38000	Bellow Wound Irrigation / Drain System	Each

Phoenix™ Wound Lavage System

- Rapid draw-off delivery system
- Simple to use, adjust and maintain
- Provides effective lavage for wound management
- Versatile, accurate, efficient and semi-disposable
- Lightweight, durable and economical



Item	Product Description	UOM
40550	Phoenix™ Wound Lavage System	Each

Wrapid-CUT™



- Unique and specially designed cutting instrument used to cut and remove foot wraps, ID bands and ear tags
- Designed to use on most standing cows, eliminating the need for bandage removal by restraint with a hoof trimming table or by lifting the bandaged leg with a rope
- Saves time and reduces the risk of injury to the bandaged patient
- Recessed cutting blade, enclosed within a guarded frame, allows user to slide the instrument under a bandaged hoof and safely cut the bandage
- Durable handle grip contoured for comfort and ease of use
- Handle features a guard extending the length of the instrument providing separation of the user from the cutting edge of the instrument
- Manufactured of durable plastic with the blade securely insert-molded into the handle
- Many additional uses including the removal of matted fur on dogs and cats, efficient use in large animal surgeries or any other applications requiring safe and effective cutting
- Patent pending globally
- Autoclavable



Item	Product Description	UOM
38500	Wrapid-CUT™	Each



LikShield™ **PATENTED**

- Protects large body areas post surgically
- Highly effective, fast acting relief for most pets
- Provides a safe, mild electric stimulus to the pet's tongue to deter licking
- Tingling sensation and unpleasant taste will prevent pets from licking, allowing wound to heal
- Center cut-out (vented) portion of bandage allows for incision site ventilation and treatment
- Proven in veterinary trials to be over 90% effective, regardless of size, age or breed of pet
- FDA-approved adhesive can be applied directly to skin around an incision or over a bandaged area
- Available in a resizable 6" x 9" patch for wide-area coverage: abdomen, loin, back, tail head, etc.
- Effective treatment for:
 - ◆ Surgical incisions
 - ◆ Wound management
 - ◆ Splints and casted areas
 - ◆ Urinary catheters
 - ◆ Seton drains
 - ◆ IVs

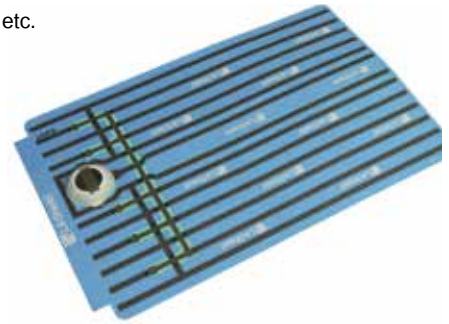

Item	Product Description	UOM
57625	LikShield™ Patch, 6" x 9"	18/Box

StopLick™ **PATENTED**

- Extremity management and behavioral modification tool
- Provides a safe, mild electric stimulus to the pet's tongue to deter licking
- Tingling sensation and unpleasant taste will prevent pets from licking
- Highly effective, fast acting relief for most pets
- Applied over a bandage placed over the wound site
- Proven in veterinary trials to be over 90% effective, regardless of size, age or breed of pet
- Alternative to Elizabethan Collar and Bitter Apple Spray
- Color coded, available in 1.62" and 3" widths
- Effective treatment for:
 - ◆ Behavioral modification tool for lick granulomas and/or self-mutilation
 - ◆ Licking, tearing at surgical stitches
 - ◆ Pulling out IVs, Seton drains, urinary catheters
 - ◆ Dogs, cats or other small animals
 - ◆ Deterring other pets from tampering with bandages



57605



57615

Item	Product Description	UOM
57605	StopLick™ Wide, 3" x 12"	12/Box
57615	StopLick™ Narrow, 1.62" x 12"	12/Box
57616	StopLick™ Mixed Pack, 6 Wide & 6 Narrow	12/Box



Horse Aid™ Kit CREATIVE PET PRODUCTS™

Kit contains essential items for horse first aid emergencies:

- Horse First Aid Book
- Corona Antiseptic Ointment
- 4" Flexible Cohesive Wrap
- Latex Tourniquet
- Saline Solution
- Iodine Prep Pads
- 3-Ply Towels
- Surgical Scrub Brush
- Iodine Solution
- Stainless Steel Scissors
- Syringe
- Hydrogen Peroxide
- Vinyl Gloves
- 4" x 4" Gauze Pads
- 6" x 9" Cold Pack
- Alcohol Prep Pads
- Thermometer with Case



Item	Product Description	UOM
10140	Horse Aid™ Kit	Each

Sporting Dog™ Premium First Aid Kit CREATIVE PET PRODUCTS™

Premium first aid kit for sporting dogs includes emergency first aid supplies:

- Alcohol Prep Pads
- Practical First Aid Book for Dogs & Cats
- 4" x 4" Gauze Pads
- Heavy Duty Water Resistant Bag
- 3-Ply Towels
- Iodine Solution
- Saline Solution
- Stainless Steel Scissors
- Hydrogen Peroxide
- Vinyl Gloves
- Bullseye™ Pillgun
- Surgical Scrub Brush
- Bleed-X®
- Syringe
- Hydrocortisone Cream
- 2" Flexible Cohesive Wrap
- Triple Antibiotic Ointment
- Latex Tourniquet
- 3" Cotton Swabs
- Cotton Balls
- Iodine Prep Pads
- Skin Staple Gun
- 6" x 9" Cold Pack
- Stainless Steel Forceps
- Eye Wash
- Pet Credentials™ Book
- Thermometer with Case



Item	Product Description	UOM
10145	Sporting Dog™ Premium First Aid Kit	Each

Sporting Dog™ II First Aid Kit CREATIVE PET PRODUCTS™

Basic essential first aid kit for sporting dogs includes standard emergency first aid supplies:

- Alcohol Prep Pads
- Practical First Aid Book for Dogs & Cats
- 4" x 4" Gauze Pads
- Heavy Duty Water Resistant Bag
- 3-Ply Towels
- Iodine Solution
- Saline Solution
- Stainless Steel Scissors
- Hydrogen Peroxide
- Vinyl Gloves
- Bullseye™ Pillgun
- Surgical Scrub Brush
- Bleed-X®
- Syringe
- Hydrocortisone Cream
- 2" Flexible Cohesive Wrap
- Triple Antibiotic Ointment
- Latex Tourniquet
- 3" Cotton Swabs
- Cotton Balls
- Iodine Prep Pads



Item	Product Description	UOM
10148	Sporting Dog™ II First Aid Kit	Each

BLEED-X is a registered trademark of Vet Brands International.



Bow Ow™ Dog First Aid Kit

CREATIVE PET PRODUCTS™

Basic first aid kit for dogs includes first aid essentials:

- 6" x 9" Cold Pack
- Hydrocortisone Cream
- Vinyl Gloves
- Tweezers
- Splint Material
- Stainless Steel Scissors
- 2" x 2" and 4" x 4" Gauze Pads
- Antiseptic Wipes
- Stretch Gauze Roll
- Cotton Balls
- Triple Antibiotic Ointment
- Bleed-X®
- 2" Elastic Bandage
- Sticker for Emergency Numbers
- .5" Adhesive Tape
- Pet Alert Door Card
- 3" Cotton Swabs
- Practical First Aid Book for Dogs & Cats



Item	Product Description	UOM
10130	Bow Ow™ Dog First Aid Kit	Each

Me Ow™ Cat First Aid Kit

CREATIVE PET PRODUCTS™

Basic first aid kit for cats includes first aid essentials:

- 6" x 9" Cold Pack
- Hydrocortisone Cream
- Vinyl Gloves
- Tweezers
- Splint Material
- Stainless Steel Scissors
- 2" x 2" and 4" x 4" Gauze Pads
- Antiseptic Wipes
- Stretch Gauze Roll
- Cotton Balls
- Triple Antibiotic Ointment
- Bleed-X®
- 2" Elastic Bandage
- Sticker for Emergency Numbers
- .5" Adhesive Tape
- Pet Alert Door Card
- 3" Cotton Swabs
- Practical First Aid Book for Dogs & Cats
- Hairball Remedy



Item	Product Description	UOM
10131	Me Ow™ Cat First Aid Kit	Each

Practical Pet First Aid Book for Dogs & Cats

CREATIVE PET PRODUCTS™

This book provides simple but effective methods to follow in an emergency. It will assist the pet owner in providing them confidence in their ability to stabilize and support their pet prior to their veterinarian's professional care, service and expertise.

The text begins by instructing the pet owner on how to evaluate their pet's physical characteristics by measuring and knowing their pet's vital signs. This detail may be used in helping to identify conditions and to support their pet during traumatic or stressful situations. Familiarity with their pet's physical characteristics as well as behavior provide key baseline information. The pet owner's knowledge and intuition are important pieces of information that only they can supply. Providing proper care in an emergency increases the likelihood of a positive outcome.



Item	Product Description	UOM
10147	Book, "Practical Pet First Aid for Dogs & Cats"	Each



The K9 Aspirator / Resuscitator Kit and K9 Police & Military First Aid Kit help provide triage to dogs that help fight wars around the world and dogs that keep our homeland and borders safe. These kits are unique because they address the different first aid demands that must be met for the various ways that K9 units are deployed around the world today.

K9 Aspirator / Resuscitator Kit CREATIVE PET PRODUCTS™

The kit attaches to the K9 Police & Military First Aid Kit for a convenient carrying option.

Kit includes:

- Aspirator / Resuscitator Pump
- Aspirator Mask - Large
- Resuscitator Mask - Large
- Oxygen Recovery Mask - Large
- Supplemental Oxygen Adapter - Large
- Heavy Duty Water Resistant Bag with Shoulder Strap



Item	Product Description	UOM
10152	K9 Aspirator / Resuscitator Kit	Each

K9 Police & Military First Aid Kit CREATIVE PET PRODUCTS™

The kit attaches to the K9 Aspirator / Resuscitator Kit for a convenient carrying option.

Kit includes:

- | | |
|--|--|
| <ul style="list-style-type: none"> • First Aid book • Heavy Duty Water Resistant Bag with Shoulder Strap • Staple Gun • Antiseptic Iodine Solution • 6" x 9" Cold Packs • Hydrogen Peroxide • Emergency Blanket • Toxiban Charcoal • Eye Wash • Bleed-X® • Digital Thermometer • 2" and 4" Flexible Cohesive Wrap • Stethoscope • Snake Bite Kit • Alcohol Prep Pads • Iodine Pads • Gauze Pads • 3-Ply Towels • Saline Solution • Stainless Steel Scissors • Stainless Steel Forceps | <ul style="list-style-type: none"> • Surgical Scrub Brush • Syringe • Hydrocortisone Cream • Triple Antibiotic Ointment • Cotton Swabs and Cotton Balls • Latex Tourniquets • Vinyl Gloves • Bullseye™ Pillgun • 36" Splint |
|--|--|



10150



10151

Item	Product Description	UOM
10151	K9 Police & Military First Aid Kit	Each
10150	K9 First Aid / Aspirator / Resuscitator - Complete Kit	Each



Spray Tip Applicators

The luer lock Spray Tip Applicators are offered in various lengths for use on a surface, in a wound, cavity, canal or nostril. All devices are produced to create specific spray patterns when a syringe is compressed or a repeatable dispensing instrument is utilized. Each tip has a specific particle size when actuated due to the variable configuration of the exit port.

Item	Product Description	UOM
73820	Spray Tip Applicator, 2" Flexible	10/Bag
73823	Spray Tip Applicator, 6" Flexible	10/Bag
73825	Spray Tip Applicator, Dome	10/Bag
73827	Spray Tip Applicator, Mist	10/Bag

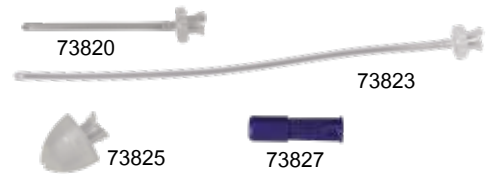

ORAL MEDS™ Dispensers

CREATIVE PET PRODUCTS™

The ORAL MEDS™ Dispensers offer a simple, accurate method for administering pills, liquid medications or supplements to small and large animals. ORAL MEDS™ syringe dispensers are available in 15 cc, 35 cc and 60 cc sizes, as well as an eye dropper. Packaged for display, ORAL MEDS™ Dispensers eliminate the "hit or miss" of oral feeding and medicating of animals.

Item	Product Description	UOM
10172	ORAL MEDS™ Oral Syringe, 15 cc	Each
10173	ORAL MEDS™ Oral Syringe, 35 cc	Each
10174	ORAL MEDS™ Oral Syringe, 60 cc	Each
10175	ORAL MEDS™ Eye Dropper (2 Pack)	Each



Flea / Lice Combs



A diagnostic and home management tool for identifying flea and lice infestation. May be used as an inexpensive customer gift. Special order options available with clinic name printed on the flea combs, minimum order of 1,000.

- 2" x 3" fits comfortably in hand
- Multi-colored
- Double-sided, one side detects fleas, the other side detects lice nits

Item	Product Description	UOM
50908	Flea / Lice Combs & Container, Mixed Colors	100/Jar
50905WH	Flea / Lice Combs, White	1,000/Pkg
50905MC	Flea / Lice Combs, Mixed Colors	1,000/Pkg



MaxLatch™ Clip-on Kennel Bowl

The MaxLatch™ Feeding Bowl is a specially designed, reliable feeding and watering bowl for cats, dogs and other companion animals. The plastic bowl has dual locking latches that easily secure the bowl to a kennel or carrier door rather than using retention rings.

- No assembly required
- Easy to clean and dishwasher safe
- Two latch clips are easy to operate and fasten securely to kennel or carrier door
- Affixation and removal take seconds with ergonomic finger release

Item	Product Description	UOM
50650	MaxLatch™ Clip-on Kennel Bowl	Each



The Gripper™ Feline Pill Gun

The Gripper™ Feline Pill Gun features a unique trigger action delivery handle which separates it from other small pill guns or bolus delivery systems. Dispensing shafts accommodate a variety of bolus or pill retention cups.

- Collet-like grip prevents pill from falling out prior to patient delivery
- Short trigger stroke for dispensing pills
- Handles may be engraved or decorated with a logo or lettering

Item	Product Description	UOM
64007	The Gripper™ Feline Pill Gun, 2 - 4 mm Bolus, 5.5 cm Shaft Length	Each



Genesis Luer Lock Syringe & Extended Probe for Microchip Delivery

PATENTED

- For delivery of microchips from preloaded needles
- Luer lock fits any luer needle system
- Plunger designed to deliver solid dose or microchips
- Single use item

Item	Product Description	UOM
Call for info	Genesis Luer Lock Syringe & Extended Probe for Microchip Delivery	Each



Dr. Larson's™ Aural Hematoma Tube



- Used in the treatment of auricular hematomas in dogs and cats
- Ideal design for use as a drain tube in the ear of a dog or cat
- Flexible retaining fingers help to keep tube in place without use of tape once tube is inserted into affected area
- Flow-through design of tube allows for continuous drainage of affected area and infusion of medicine or flushing solution
- Individually packaged and gamma irradiated
- Single use item

Item	Product Description	UOM
27588	Dr. Larson's™ Aural Hematoma Tube	10/Bag



Mouth Gags

Mouth gags enable a practitioner to pass a feeding tube into a patient's esophagus without fear of the animal biting the tube in half or stopping the flow rate by clenching its mouth shut.

Item	Product Description	UOM
50301	Mouth Gag, Small, Small Cats	Each
50303	Mouth Gag, Large, Large Cats & Small Dogs	Each
50305	Mouth Gag, X-Large, Large Dogs	Each



Cadaver Bags

Heavy duty plastic bags to place pets in after death. Humane without added cost. Provides a necessary service and is a valued product for the clinic. Cadaver bags are blue in color, conveying a sense of compassion and caring.

- Color - blue
- Superior strength - 3.5 mil thickness
- Packaged on a roll for easy dispensing
- Two convenient sizes
- Single use item

Item	Product Description	UOM
27601	Cadaver Bag, Small, 24" x 30"	100/Roll
27605	Cadaver Bag, Large, 30" x 50"	50/Roll



Veterinary Small Animal Medical Bag

Black canvas with embroidered veterinary caduceus emblem.

- Dimensions: 12" L x 8" W x 7" H in open position
- Unique design
- Soft sided bag with numerous pockets
- Small size bag with large capacity

Item	Product Description	UOM
40050	Veterinary Small Animal Medical Bag	Each



Vet Case, DVM Medical

High density thermoformed black plastic construction.

- Dimensions: 18" L x 10" W x 12" H
- Two side compartments
- Similar to the Pandora Vet Case

Item	Product Description	UOM
01120	Vet Case, DVM Medical	Each



Lead Gloves

- One-piece molded design with a soft urethane exterior
- Covers remove easily to inspect the protective qualities of the lead core
- Features a breathable nylon liner for comfort
- Blue / green vinyl - 0.5 mm protection
- Latex free - 15" (one size only)

Item	Product Description	UOM
52810	Lead Gloves	Pair



Sta-put™ Ear Tag Applicator



- Plastic handled hidden blade knife in closed position for applying single piece ear tags
- Knife is constructed of hardened stainless steel
- When blade is removed and unfolded from the encased handle, it is rigidly affixed and secured in place to the handle
- Blade accepts one-piece ear tags as the flattened elbowed ear retention tongue is fixed to the notched area at the sharpened point of the knife. The notch retaining the one-piece tag allows the piercing of feed lot cattle's ear and entry of the flattened ear tag bar through the ear
- Upon entry the knife is withdrawn and the notched knife releases the tag which returns to its normal elbowed position securing it to the ear as the knife is withdrawn
- Easy to load tags and apply



Item	Product Description	UOM
40605	Sta-put™ Ear Tag Applicator	Each

Sta-put™ Ear Tag Pliers



- Designed specifically for applying ear tags to sheep, goats and small ruminants in a plier configuration
- Applies any single piece tag utilizing a stud to pierce an ear and snap locks onto the opposing end of the flexible tag
- Routinely functional with both standard ear tags and RFID loaded tags
- May be customized to any style tag and working head to readily function with application



Item	Product Description	UOM
72500	Sta-put™ Ear Tag Pliers	Each

Trochar



- Guarded Trochar for use in acute bloats needing immediate relief
- Simple sharp pointed working end exposed when protective sheath is removed



Item	Product Description	UOM
42710	Trochar	Each

**GET WHAT YOU NEED...
STRAIGHT FROM THE HORSE'S MOUTH!**

Visit
maianimalhealth.com
to browse our selection.



Clip-Its™ Visual Reminders

Visual Management

PATENTED

Clip-Its™ are a visual aid used to provide specialized care instructions to staff and clinicians regarding a patient's requirements. The color coded Clip-Its™ provide direction regarding patient needs and expectations of staff, as well as awareness of patient personalities.

Clip-Its™ provide a visual reminder to ensure patient care instructions are not overlooked. The Clip-Its™ provide clear direction and instruction to everyone involved in patient care.

- Increase **Communication** and **Consistency** of staff directives or instructions
- Color coded system is easy to follow
- 3" x 3" engraved signs with alligator clip for attachment to cage
- Simple and reliable visual communication
- Engraved, permanent instructions provide consistent patient care
- System may be used within a clinic, a kennel or grooming facility with customization available to accommodate clinic needs
- Durable, laminated material for extended usage
- Easily attaches to a cage, kennel, run, etc. and may be clipped together vertically for multiple directions / instructions
- Carabiners may also be used to hang Clip-Its™

Clip-Its™ - Red with White Text - Warning, Safety Issues

Item	Product Description	UOM
92502	Clip-Its™ AGGRESSIVE DOG	6/Bag
92504	Clip-Its™ CAUTION, CAUTION	6/Bag
92506	Clip-Its™ <u>CONTAGIOUS!</u> CAUTION	6/Bag
92508	Clip-Its™ ESCAPE RISK	6/Bag
92509	Clip-Its™ <u>CAUTION</u> FEARFUL	6/Bag
92510	Clip-Its™ <u>CAUTION</u> FRACTIONIOUS CAT	6/Bag
92512	Clip-Its™ WILL BITE	6/Bag
92515	Clip-Its™ NEEDS CLEANING	6/Bag
92516	Clip-Its™ NEEDS SANITIZING	6/Bag
92518	Clip-Its™ REACTIVE PATIENT	6/Bag
92500VW	Clip-Its™ Variety Pack - WARNING	10/Bag



Clip-Its™ - Yellow with Black Text - Caution, Diagnostic Conditions that Require Special Attention

Item	Product Description	UOM
92520	Clip-Its™ POTENTIALLY CONTAGIOUS PATIENT! USE CAUTION!	6/Bag
92522	Clip-Its™ DIABETIC	6/Bag
92526	Clip-Its™ <u>NO FOOD NO WATER</u>	6/Bag
92528	Clip-Its™ SEIZURE WATCH	6/Bag
92530	Clip-Its™ SURGERY TODAY	6/Bag
92531	Clip-Its™ IN HEAT	6/Bag
92532	Clip-Its™ REMOVE CATHETER	6/Bag
92500VC	Clip-Its™ Variety Pack - CAUTION / DIAGNOSTIC	7/Bag



Clip-Its™ - Orange with White Text - Medication & Special Diet Considerations

Item	Product Description	UOM
92540	Clip-Its™ FOOD ALLERGIES	6/Bag
92542	Clip-Its™ HAS OWN MEDS	6/Bag
92544	Clip-Its™ MEDS IN REFRIGERATOR	6/Bag
92546	Clip-Its™ MEDS TO GO HOME WITH CLIENT	6/Bag
92548	Clip-Its™ NEEDS MEDS	6/Bag
92550	Clip-Its™ NEEDS VACCINATIONS	6/Bag
92552	Clip-Its™ <u>NO FOOD WATER OKAY</u>	6/Bag
92554	Clip-Its™ ON MEDICATIONS	6/Bag
92556	Clip-Its™ SPECIAL DIET	6/Bag
92500VM	Clip-Its™ Variety Pack - MEDICATION / SPECIAL DIET	9/Bag



Clip-Its™ - White with Black Text - Specimen Samples or Exam Required

Item	Product Description	UOM
92560	Clip-Its™ COLLECT BLOOD SAMPLE	6/Bag
92562	Clip-Its™ COLLECT FECAL SAMPLE	6/Bag
92564	Clip-Its™ COLLECT URINE SAMPLE	6/Bag
92566	Clip-Its™ NEEDS EXAM	6/Bag
92500VS	Clip-Its™ Variety Pack - SPECIMEN / EXAM	4/Bag



Clip-Its™ - Blue with White Text - General Information for Kennel Help

Item	Product Description	UOM
92580	Clip-Its™ CAGE MUST BE CLEANED	6/Bag
92582	Clip-Its™ HAS OWN BELONGINGS	6/Bag
92584	Clip-Its™ HAS OWN COLLAR, LEASH	6/Bag
92586	Clip-Its™ HAS OWN CARRIER	6/Bag
92588	Clip-Its™ HAS OWN FOOD	6/Bag
92590	Clip-Its™ NEEDS BATH	6/Bag
92592	Clip-Its™ NEEDS GROOMING	6/Bag
92594	Clip-Its™ <u>NO</u> BLANKETS	6/Bag
92596	Clip-Its™ NO NECK LEASH	6/Bag
92598	Clip-Its™ READY TO GO	6/Bag
92500VK	Clip-Its™ Variety Pack - INFORMATION / KENNEL HELP	10/Bag



Clip-Its™ - Green/Red with White Text - Oxygen Informational

Item	Product Description	UOM
92513	Clip-Its™ EMPTY OXYGEN CYLINDER DO NOT USE, Red/White	6/Bag
92599	Clip-Its™ OXYGEN ON / OXYGEN OFF, Double-Sided	Each
92500VO	Clip-Its™ Variety Pack - OXYGEN INFORMATION- 2 Full, 2 Empty, 1 On / Off	10/Bag



Clip-Its™ - Green with White Text - Oxygen GO / READY

Item	Product Description	UOM
92513	Clip-Its™ EMPTY OXYGEN CYLINDER DO NOT USE, Red/White	6/Bag
92599	Clip-Its™ OXYGEN ON / OXYGEN OFF, Double-Sided	Each
92500VO	Clip-Its™ Variety Pack - OXYGEN INFORMATION- 2 Full, 2 Empty, 1 On / Off	10/Bag



Write-Boards™ Visual Management

Write-Boards™ provide an effective method of communication between staff related to patient requirements. Using Write-Boards™ allows you to create individualized messages for others to follow. Write-Boards™ clip to a cage, kennel, run, etc. and provide high visibility. Write-Boards™ are reusable and may be used in various ways to remind staff of details including supplies needed, clinic needs, equipment maintenance and ultimately for the promotion of high quality patient care.

- Simple, cost effective method of communication
- Reusable and visible
- Inventory control management aid directions / instructions
- May be clipped together vertically for multiple directions / instructions
- Multitude of office and clinic uses in addition to patient care
- Permanent black marker wipes off with alcohol
- Dry erase marker wipes off easily
- Choice of carabiner or clip to hang



Item	Product Description	UOM
92700WH	Write-Boards™ - 3" x 3" White	6/Bag
92700YL	Write-Boards™ - 3" x 3" Yellow	6/Bag
92700RD	Write-Boards™ - 3" x 3" Red	6/Bag
92700GR	Write-Boards™ - 3" x 3" Green	6/Bag
92700VWB	Write-Boards™ - 3" x 3" Variety Pack - 2 White, 2 Yellow, 1 Green, 1 Red	6/Bag
92720WH	Write-Boards™ - 3" x 6" White	3/Bag
92720YL	Write-Boards™ - 3" x 6" Yellow	3/Bag
92720GR	Write-Boards™ - 3" x 6" Green	3/Bag
92724	Write-Boards™ - 12" x 4" Brass Plate Slide Holder	Each
92725WH	Write-Boards™ - 12" x 4" White Plate Magnetic Back	3/Bag
92725YL	Write-Boards™ - 12" x 4" Yellow Plate Magnetic Back	3/Bag
92726WH	Write-Boards™ - 12" x 4" White Slide Plate	3/Bag
92726YL	Write-Boards™ - 12" x 4" Yellow Slide Plate	3/Bag
92730WH	Write-Boards™ - 6" x 6" White 2 Hole	3/Bag
92730YL	Write-Boards™ - 6" x 6" Yellow 2 Hole	3/Bag



92730WH



92726YL



3" x 3"



3" x 6"

Write-Boards™ - Engraved

Item	Product Description	UOM
92721WH	Write-Boards™ - 3" x 6" White - CLEANED	3/Bag
92722WH	Write-Boards™ - 3" x 6" White - SANITIZED	3/Bag



92721WH



92722WH



Engraved Business Signs - Client / Clinic Information

Engraved Business Signs provide clients with critical details and clinic policies. Most veterinary clinics share common policies and critical details in their daily operations. For this reason, the statements inscribed on our Business Signs are messages universally used and required in veterinary practices. Sign customization is also available.

- Effective method of communication
- Color coded according to general content and urgency
- Size available: 8" x 6"

Warnings to Clients & Staff - Red with White Text

Item	Product Description	UOM
93000	AGGRESSIVE AND/OR DESTRUCTIVE PETS MAY BE DENIED SERVICE.	Each
93001	CAUTION HOT AUTOCLAVE	Each
93002	CAUTION! LASER IN USE EYE PROTECTION REQUIRED!	Each
93004	CAUTION RADIOLOGY - DO NOT ENTER IF PREGNANT	Each
93006	CAUTION OXYGEN NO SMOKING NO OPEN FLAMES	Each
93008	Gloves, Aprons And Thyroid Protectors REQUIRED During Procedure.	Each
93010	EMPTY OXYGEN CYLINDERS DO NOT USE	Each
93012	SURGERY PREP AREA	Each
93014	NOT AN EXIT	Each
93112	CAUTION RADIOLOGY (OCTAGON) 8" x 8"	Each



Assistance Provided to Clients & Staff - Green with White Text

Item	Product Description	UOM
93060	Ask About Our Wellness Plan And How It Can Benefit You.	Each
93062	Boarding Services Are Available For Your Pets.	Each
93064	If Your Pet Has An Accident PLEASE Let Our Staff Know So We Can Take Care Of It For You.	Each
93066	PLEASE ALLOW OUR STAFF TO HANDLE YOUR PET IF NEEDED.	Each
93068	CLIENTS WILL BE SEEN IN THE FOLLOWING ORDER: EMERGENCIES - APPOINTMENTS - WALK-INS THANK YOU FOR YOUR PATIENCE AND COOPERATION!	Each
93070	FULL OXYGEN CYLINDERS READY FOR USE	Each



Lighthearted Engaging Directions - Black with White Text

Item	Product Description	UOM
93080	Unattended Children Will Be Given A Cappuccino And A FREE KITTEN Then Sent Home. THANK YOU!	Each
93081	Unattended Children Will Be Given A Cappuccino And A FREE PUPPY Then Sent Home. THANK YOU!	Each
93084	PLEASE DO NOT Let The Cats Out No Matter What They Tell You. Thank You!	Each



Notice to Clients & Staff - Yellow with Black Text

Item	Product Description	UOM
93020	<u>NOTICE:</u> This Property Is Protected By Surveillance Cameras 24 Hours/Day. (Also available in 8" x 12" size)	Each
93022	Personnel Are NOT Present On Premises For 24 Hour Observation Of Patients.	Each
93024	A Current Rabies Vaccine Is Required By Law For All Patients.	Each
93026	Due To Federal Law Prescriptions Can Not Be Dispensed Without Seeing The Patient.	Each
93028	In Cooperation With The Law We Can Not Accept Returned Medications.	Each
93030	NO SMOKING INSIDE OR WITHIN 15 FEET OF BUILDING	Each
93032	<u>BEYOND THIS POINT</u> Non-Personnel Must Be Accompanied By A Staff Member. THANK YOU!	Each



Expectations of the Clients, Patients & Staff - Blue with White Text

Item	Product Description	UOM
93040	ALL PETS MUST BE KEPT ON LEASH OR IN A CARRIER.	Each
93042	If You Are Leaving Your Pet With Us, Please See Receptionist To: 1. Sign Estimate And Release Form 2. Leave A Deposit Thank You!	Each
93044	PLEASE WALK YOUR DOGS BEFORE ENTERING THE BUILDING.	Each
93046	Payment Is Due At The Time Services Are Rendered. Thank You!	Each
93048	PLEASE Turn Off All Cell Phones. Your Attention Is Required To Give You Our Best Customer Service.	Each
93050	For The Safety Of All Our Clients And Patients, All Pets Must Be On A Leash.	Each
93052	<u>NOTICE:</u> Employees Must Wash Hands Before Leaving Restroom.	Each
93054	SCALE FOR ANIMAL USE ONLY. THANK YOU!	Each



Acknowledgement & Appreciation from the Clinic - Maroon with White Text

Item	Product Description	UOM
93090	Thank You For Giving Us The Opportunity To Serve You!	Each



Sanitation Signs - 8" x 8" - Red with White Text

Item	Product Description	UOM
93110	PLEASE Do NOT Lift Your Leg On Our Pretty Flowers. Thank you!	Each



Sanitation Signs - Yellow with Black Text

Item	Product Description	UOM
93120	DESIGNATED PET POTTY AREA HERE - 8" x 8"	Each
93122	← PET POTTY AREA - 8" x 8"	Each
93124	PET POTTY AREA → - 8" x 8"	Each
93100	Your Dog Did His Duty...Clean Up After Your Pet - 9" x 12"	Each



Outdoor Informational Sign - 24" x 12" - Green with White Text

Item	Product Description	UOM
93126	PLEASE KEEP PETS OFF LANDSCAPING	Each



ADA Compliant Braille Restroom Signs - Blue or Black with White Text

Item	Product Description	UOM
93180	Restroom Unisex - 8" x 8"	Each
93181	Restroom Unisex with Wheel Chair - 8" x 8"	Each
93182	Restroom Male - 6" x 8"	Each
93183	Restroom Female - 6" x 8"	Each



Engraved Business Signs - Identification of Rooms, Staff & Clinic Detail

Engraved Business Signs also include signage for clinic rooms and staff. Signs are vital for communication among clinic personnel as well as enhancing the quality of interactions between clinic personnel and their customers. This is especially important in larger clinics or clinics which have rotating personnel. Proper and clear identification of rooms promotes better flow patterns through the clinic to maximize the building's capacity. Identifying and clearly marking small details such as cages and kennels can reduce mistakes and enhance communication.

- Room identification signs
- Staff identification:
 - ◆ Signage for desk or reception
 - ◆ Personnel badges
- Restrooms
- Kennels and numbering
- Cages and numbering
- Operation / application identification

Room Identification - 10" x 2" - Maroon / White or Black / White

Item	Product Description	UOM
93205	Boarding	Each
93209	DO NOT ENTER	Each
93211	Exam Room 1	Each
93246	Supply Room	Each
* Examples of signs we offer. Additional signs available, please call for more information.		



"The Slider" Room Signs - 13" x 2" - Black with White Text

Item	Product Description	UOM
93261	Exam Room 1	Each
93262	Exam Room 2	Each
93263	Exam Room 3	Each
93264	Exam Room 4	Each
93270	Radiology	Each

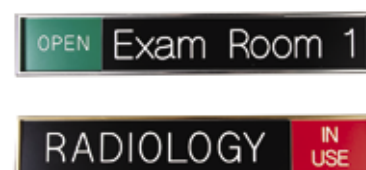

Signs & Mounts

Engraved Corridor Signs provide for easy navigation for your clinic, hospital or business. Engraved on industrial strength material, these signs are easy to read, easy to install and professional in appearance.

- Size: 10" x 4"
- Double-sided engraved sign with choice of text
- Choice of left arrow or right arrow
- Choice of Silver Mount or Copper Mount

Item	Product Description	UOM
93272	Corridor Sign	Each



Stylized Numbers - 5" x 5" - Parchment / Black or Tan / Brown

Item	Product Description	UOM
93301	Paw Room 1	Each
93302	Paw Room 2	Each
93303	Paw Room 3	Each
93304	Paw Room 4	Each
93305	Paw Room 5	Each



Employee Identifier - 3" x 1"

Item	Product Description	UOM
93500	Green / White - VOLUNTEER	Each
93505	Yellow / Black - IN TRAINING	Each



Engraved Name Badges - 3" x 1" - Available in Multiple Colors

Item	Product Description	UOM
93160	Engraved Name Badge with Paw	Each
93161	Engraved Name Badge with Vet Symbol	Each
93162	Engraved Name Badge with Vet Tech Symbol	Each
93163	Engraved Name Badge with Border	Each
* Please call for personalization.		



Oaths - Wood Plaques - Gold / Black or Black / Gold (Ultra Matte) or Tan / Brown (Textured)

Item	Product Description	UOM
93403	Veterinarian Oath, 9" x 7"	Each
93406	Veterinary Technician Oath, 9" x 7"	Each
93400	Veterinary Medicine Oath, 12" x 9"	Each
93402	Veterinary Medicine Technician Oath, 12" x 9"	Each



Compassionate Signs - 4" x 4" - Gold / Black, Black / Gold, Royal Blue / White or Maroon / White

Item	Product Description	UOM
We Shared So Many Moments without Ever Saying A Word, You Spoke With Your Eyes, Laughed With Your Tail and Loved With Your Heart.		
94000	We Shared So Many Moments	Each
"Listen Carefully You Will Hear the Soft PURRR of Angel Wings"		
94002	Listen Carefully You Will Hear	Each



Compassionate Signs - Sun Catcher - 4" x 4" - Royal Blue or Maroon

Item	Product Description	UOM
We Shared So Many Moments without Ever Saying A Word, You Spoke With Your Eyes, Laughed With Your Tail and Loved With Your Heart.		
94010	We Shared So Many Moments	Each
"Listen Carefully You Will Hear the Soft PURRR of Angel Wings"		
94012	Listen Carefully You Will Hear	Each



Informational Fire Signs - 6" x 4" - Red with White Text

Item	Product Description	UOM
93131	IN CASE OF FIRE 1 CAT IN HOUSE	Each
93132	IN CASE OF FIRE 2 CATS IN HOUSE	Each
93141	IN CASE OF FIRE 1 DOG IN HOUSE	Each
93142	IN CASE OF FIRE 2 DOGS IN HOUSE	Each



Table Tent Sign - 3" x 3" - Red with White Text

Item	Product Description	UOM
92802	CLEANED READY FOR USE	3/Pkg



Sublimated Business Signs - Identification of Rooms & Staff Visual Management

Sublimation is a printing process using heat to transfer dye onto polycoated signage materials. Sublimation creates a high quality, full color, photo finish which will not fade, chip or flake off the material. May be customized to create high value signage for your business.

Sublimated Oval Room ID Signs - 5" x 3" - Available in Multiple Colors

Item	Product Description	UOM
93281	Exam Room 1	Each
93282	Exam Room 2	Each
93283	Exam Room 3	Each



Sublimated Name Badges - Available in Multiple Colors

Item	Product Description	UOM
93150	Sublimated Name Badge with Paws	Each
93151	Sublimated Name Badge with Vet Symbol	Each
93152	Sublimated Name Badge with Vet Tech Symbol	Each
93153	Sublimated Name Badge with No Logo	Each

*Please call for personalization.



3-UP Reminder Cards Visual Management

Size: 8-1/2" x 11" sheets burst to 3 - 6" x 3-5/8" cards.

Item	Product Description	UOM
93630-3	3-UP Reminder Cards - Pet Health Alert	750 Cards/Bag
93631-3	3-UP Reminder Cards - Oops	750 Cards/Bag
93632-3	3-UP Reminder Cards - Norman Rockwell Style	750 Cards/Bag



4-UP Reminder Cards Visual Management

Size: 8-1/2" x 11" sheets burst to 4 - 4-1/4" x 5-1/2" cards.

Item	Product Description	UOM
93630-4	4-UP Reminder Cards - Pet Health Alert	200 Cards/Bag
93631-4	4-UP Reminder Cards - Oops	200 Cards/Bag
93632-4	4-UP Reminder Cards - Norman Rockwell Style	200 Cards/Bag

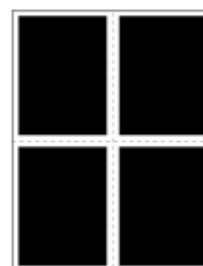

EduPet™ Client Handouts



Professional, non-commercial EduPet™ handouts promote your services and the importance of preventative care. Mix / match per 100.

EduPet™ Client Handouts - 3” x 7”

Item	Product Description	UOM
95000	EduPet™ Client Handout “Why Vaccinate Your Dog?”	100/Bag
95001	EduPet™ Client Handout “Senior Pet Care”	100/Bag
95002	EduPet™ Client Handout “Heartworm Disease”	100/Bag
95003	EduPet™ Client Handout “Why Vaccinate Your Cat?”	100/Bag
95005	EduPet™ Client Handout “Feline Leukemia”	100/Bag
95006	EduPet™ Client Handout “Fleas”	100/Bag
95007	EduPet™ Client Handout “Intestinal Parasites”	100/Bag
95008	EduPet™ Client Handout “Pet Dental Care”	100/Bag
95009	EduPet™ Client Handout “Pet Report Card”	100/Bag
95010	EduPet™ Client Handout “Otitis”	100/Bag
95011	EduPet™ Client Handout “Spaying & Neutering”	100/Bag
95012	EduPet™ Client Handout “Why Complete the Initial Vaccination Series?”	100/Bag
95013	EduPet™ Client Handout “Pet Wellness Screening”	100/Bag



EduPad™ Client Handouts



A picture is worth 1,000 words. Explain problem areas professionally and visually. Note the problem, tear off and send home with client.

- Size: 6” x 4”
- Pads of 100

Item	Product Description	UOM
95030	EduPad™ Ear	100/Pad
95031	EduPad™ Eye	100/Pad
95032	EduPad™ Periodontal Disease	100/Pad
95033	EduPad™ Hip	100/Pad
95034	EduPad™ Disc	100/Pad
95035	EduPad™ Skin Disorders	100/Pad
95036	EduPad™ Anal Sac	100/Pad
95037	EduPad™ Stifle (Cruciate)	100/Pad
95038	EduPad™ Ear Canal Surgery	100/Pad
95039	EduPad™ Dental Chart	100/Pad
95040	EduPad™ Nail / Claw	100/Pad
95041	EduPad™ Internal Parasites	100/Pad
95042	EduPad™ Obese Heart	100/Pad

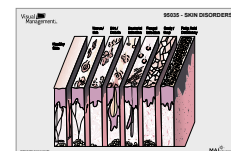
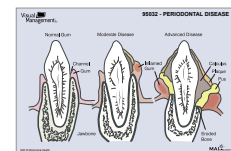
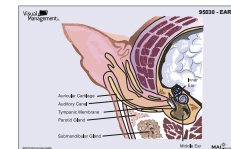

Check Out the Vetcorder™ Pro!

*Portable
Patient
Monitor*

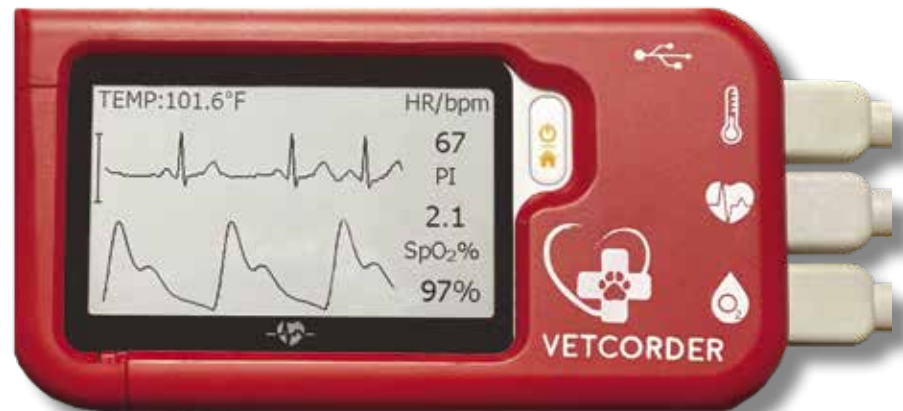

See page 125 for More Information.

Pair it with the Vetcorder Airmate™ !



A Reliable Monitoring Combo!

See page 127 for More Information.



VETCORDER™
EVERY PATIENT | EVERY TIME

Introduction to Genesis Instruments

Genesis Instruments provides practical solutions for the delivery of medicants to animals. All instruments are designed to be functional and practical. Application tied to simple reliability is part of the Genesis commitment to customers and consumers. All Genesis Instruments products are made within one or all of our global sites whether UK / Europe, Australia, New Zealand or the USA. Our staff is knowledgeable about product features and benefits providing answers to individual questions or an expert is made available. We are proud of our instruments as they are practical, simple, reliable and economical whether an implanter, medicator, applicator, oral / topical delivery or bolus dispensing. We offer products that fit the needs of application and dispensing whether small holdings or large integrators from poultry, swine to cattle.

Norm-Ject® Syringes

- All plastic syringe
- Non-spermicidal and non-embryocidal
- Eccentric (off centered) tip
- Individually packaged and sterile
- Single use item

Item	Product Description	UOM
04708	HSW Norm-Ject® Syringe, 1 cc, Sterile	100/Box
04710	HSW Norm-Ject® Syringe, 3 cc, Sterile	100/Box
04712	HSW Norm-Ject® Syringe, 5 cc, Sterile	100/Box
04714	HSW Norm-Ject® Syringe, 10 cc, Sterile	100/Box
04716	HSW Norm-Ject® Syringe, 20 cc, Sterile	100/Box
04719	HSW Norm-Ject® Syringe, 30 cc, Sterile	50/Box
04720	HSW Norm-Ject® Syringe, 60 cc, Sterile	30/Box



Pro-Ject™ 2-Piece Syringes - Luer Slip & Luer Lock Tips

A non-spermicidal, non-embryocidal syringe commonly used in artificial insemination (A.I.) and embryo transfer (E.T.) applications.

- Shorter stroke makes syringe easy to use
- Larger finger grips
- Economical for one-time disposable use
- Two-piece all plastic syringe
- Individually packaged and gamma irradiated
- Single use item

Item	Product Description	UOM
60020	Pro-Ject™ 2-Piece Syringe, Luer Slip Tip, 15 cc	100/Box
60040	Pro-Ject™ 2-Piece Syringe, Luer Slip Tip, 35 cc	50/Box
60060	Pro-Ject™ 2-Piece Syringe, Luer Slip Tip, 60 cc	30/Box
60080	Pro-Ject™ 2-Piece Syringe, Luer Slip Tip, 80 cc	25/Box
60021	Pro-Ject™ 2-Piece Syringe, Luer Lock Tip, 15 cc	100/Box
60041	Pro-Ject™ 2-Piece Syringe, Luer Lock Tip, 35 cc	50/Box
60061	Pro-Ject™ 2-Piece Syringe, Luer Lock Tip, 60 cc	30/Box
60081	Pro-Ject™ 2-Piece Syringe, Luer Lock Tip, 80 cc	25/Box



Pro-Ject™ 2-Piece Syringes - Oral Foley Tip

- Oral foley tip syringes are non-sterile
- Fits into the end of a foley catheter
- Single use item

Item	Product Description	UOM
60022	Pro-Ject™ 2-Piece Syringe, Oral Foley Tip, 15 cc	100/Box
60042	Pro-Ject™ 2-Piece Syringe, Oral Foley Tip, 35 cc	50/Box
60062	Pro-Ject™ 2-Piece Syringe, Oral Foley Tip, 60 cc	25/Box
60082	Pro-Ject™ 2-Piece Syringe, Oral Foley Tip, 80 cc	25/Box



NORM-JECT is a registered trademark of Henke-Sass, Wolf GmbH.



Pro-Ject™ 3-Piece Syringes

- Large diameter and a short stroke to fit a small hand
- Large finger grips and thumb pad
- End tips are stronger than most competitive products
- Screen printed graduation markings do not rub off
- Non-toxic, non-pyrogenic and non-embryocidal
- Individually packaged and gamma irradiated
- Oral foley tip syringes are non-sterile
- Autoclavable and reusable



Pro-Ject™ 3-Piece Syringes - Luer Slip & Luer Lock Tips

Item	Product Description	UOM
60220	Pro-Ject™ 3-Piece Syringe, Luer Slip Tip, 15 cc	100/Box
60240	Pro-Ject™ 3-Piece Syringe, Luer Slip Tip, 35 cc	50/Box
60250	Pro-Ject™ 3-Piece Syringe, Luer Slip Tip, 60 cc	25/Box
60260	Pro-Ject™ 3-Piece Syringe, Luer Slip Tip, 80 cc	25/Box
60270	Pro-Ject™ 3-Piece Syringe, Luer Slip Tip, 100 cc	25/Box
60221	Pro-Ject™ 3-Piece Syringe, Luer Lock Tip, 15 cc	100/Box
60241	Pro-Ject™ 3-Piece Syringe, Luer Lock Tip, 35 cc	50/Box
60251	Pro-Ject™ 3-Piece Syringe, Luer Lock Tip, 60 cc	25/Box
60261	Pro-Ject™ 3-Piece Syringe, Luer Lock Tip, 80 cc	25/Box
60271	Pro-Ject™ 3-Piece Syringe, Luer Lock Tip, 100 cc	25/Box



Pro-Ject™ 3-Piece Syringes - Oral Foley Tip

Item	Product Description	UOM
60222	Pro-Ject™ 3-Piece Syringe, Oral Foley Tip, 15 cc	100/Box
60242	Pro-Ject™ 3-Piece Syringe, Oral Foley Tip, 35 cc	50/Box
60252	Pro-Ject™ 3-Piece Syringe, Oral Foley Tip, 60 cc	25/Box
60262	Pro-Ject™ 3-Piece Syringe, Oral Foley Tip, 80 cc	25/Box
60272	Pro-Ject™ 3-Piece Syringe, Oral Foley Tip, 100 cc	25/Box



Syringe Caps

Syringe Caps attach to syringe tip to allow for safe transport and/or dispensing of medication.

Item	Product Description	UOM
02201	Syringe Cap, C14 Luer Lock	1,000/Bag
02202	Syringe Cap, C14 Luer Lock	500/Vial
02203	Syringe Cap, C14 Luer Lock	100/Vial
02204	Syringe Cap, C13 Luer Slip	1,000/Bag
02205	Syringe Cap, C13 Luer Slip	500/Vial
02206	Syringe Cap, C13 Luer Slip	100/Vial
60807	Cap for Oral Foley Tip Syringe	1,000/Bag
60808	Cap for Oral Foley Tip Syringe	500/Vial
60809	Cap for Oral Foley Tip Syringe	100/Vial



Genesis Industries manufactures specialty Vented and Non-Vented Draw-Off Caps. All Genesis Draw-Off Caps are made of high density polyethylene for impact resistance. The caps have an outside diameter that is ribbed for a secure grip when sealing the cap onto the container or removing after use.

Features of Draw-Off Caps:

- An internal recess on the cap's inside face to accept tubing which may be used to remove container contents without inverting the container
- An expansion ring on the inside diameter of the cap face. The ring engages against the inside diameter of the container as the cap is threaded into position sealing the cap securely to the bottle preventing the potential for leakage when the container is inverted
- Various exit port configurations are offered to accommodate different methods of aspiration or gravitational feeding from a bottle or container
- Available vented or non-vented. Vented caps for continuous flow will equalize the pressure of container contents whereas non-vented caps will not
- All Oral Draw-Off and Luer Lock ports may be sealed with specific caps attached by lanyards to meet customer requirements
- May be custom manufactured to meet customer's needs / specifications, including custom colors

Luer Lock Draw-Off Caps

- Designed to fit any luer lock syringe
- Exit port sealed with Luer Lock Cap is attached with a fixed lanyard - avoiding loss of cap. Capped exit ports provide security of contents when not in use
- Vented or non-vented
 - ◆ Inverted: utilizes gravity feed without a stem to deliver contents
 - ◆ Upright: utilizes a stem from cap's inner surface to draw contents
- Draw-Off Caps are stocked in two colors. Please specify Black (BK) or White (WH) after item number
- Custom colors are also available



Luer Lock Port with Cap & Strap



Item	Neck Finish	Neck Height	Port Type
09-30-6519	20 mm	410	Luer Lock Port with Cap & Strap
09-30-6513	24 mm	410	Luer Lock Port with Cap & Strap
09-30-6518	24 mm	415	Luer Lock Port with Cap & Strap
09-30-6521	28 mm	410	Luer Lock Port with Cap & Strap
09-30-6522	33 mm	400	Luer Lock Port with Cap & Strap
09-30-6531	38 mm	400	Luer Lock Port with Cap & Strap
09-30-6523	38 mm	410	Luer Lock Port with Cap & Strap

Luer Slip & Genesis Oral Syringe Draw-Off Caps

- Exit port inside diameter fits any luer slip syringe for aspiration of the container contents
- Exit port outside diameter fits a Genesis Oral B15 Syringe Tip or equivalent configuration
- Vented or non-vented
 - ◆ Inverted: utilizes gravity feed without a stem to deliver contents
 - ◆ Upright: utilizes a stem from cap's inner surface to draw contents
- Exit port sealed with B15 Cap is attached with a fixed lanyard - avoiding loss of cap. Capped exit ports provide security of contents when not in use
- Draw-Off Caps are stocked in two colors. Please specify Black (BK) or White (WH) after item number
- Custom colors are also available



Oral Draw-Off Port

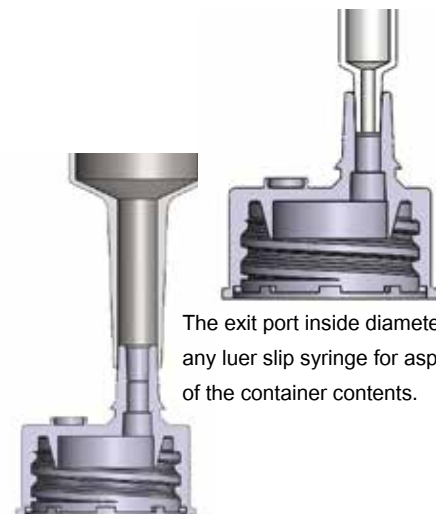

The exit port inside diameter fits any luer slip syringe for aspiration of the container contents.

The exit port outside diameter fits a Genesis Oral B15 Syringe Tip or equivalent configuration.

Item	Neck Finish	Neck Height	Port Type
09-30-6602	20 mm	410	Oral Draw-Off Port without Vent with Cap & Strap
09-30-6604	24 mm	410	Oral Draw-Off Port without Vent with Cap & Strap
09-30-6512	28 mm	410	Oral Draw-Off Port with Cap & Strap
09-30-6529	38 mm	400	Oral Draw-Off Port with Cap & Strap
09-30-6537	38 mm	410	Oral Draw-Off Port with Cap & Strap
09-30-6535	45 mm	410	Oral Draw-Off Port with Cap & Strap
09-30-6681	45 mm	410	Oral Draw-Off Port without Vent with Cap & Strap



Ribbed & Double Stepped Ribbed Exit Ports



- Designed to accommodate variable tubing diameter on the exit port depending on the customers' application
- Stepped and ribbed ports are designed and ideal to affix a mechanical clamp to any tubing diameter assembly fitted to the exit port for security
- Vented or non-vented
 - ◆ Inverted: utilizes gravity feed without a stem to deliver contents
 - ◆ Upright: utilizes a stem from cap's inner surface to draw contents

Item	Neck Finish	Neck Height	Port Type
09-30-6511	33 mm	410	Ribbed 9 mm
09-30-6515	38 mm	410	Ribbed 9 mm
09-30-6520	38 mm	410	Ribbed 13 mm
09-30-6551	45 mm	410	Ribbed 13 mm
09-30-6534	38 mm	410	Double Stepped Ribbed 9 mm & 13 mm
09-30-6514	24 mm	410	Stepped Adapter
09-30-6525	38 mm	400	Stepped Adapter
09-30-6527	38 mm	410	Stepped Adapter



Ribbed 13 mm



Double Stepped Ribbed

Barbed & Double Stepped Barbed Exit Ports



- Designed to accommodate, affix and secure variable tubing diameters to the exit port depending on the customers' application. The tubing is secured with reverse barbs preventing accidental tube removal and eliminates the use of mechanical clamps
- Contents may be dispensed using any instrument that aspirates and dispenses
- Vented or non-vented
 - ◆ Inverted: utilizes gravity feed without a stem to deliver contents
 - ◆ Upright: utilizes a stem from cap's inner surface to draw contents

Item	Neck Finish	Neck Height	Port Type
09-30-6530	38 mm	400	Double Stepped Barbed 9 mm / 13 mm
09-30-6532	38 mm	410	Double Stepped Barbed 9 mm / 13 mm
09-30-6536	38 mm	415	Double Stepped Barbed 9 mm / 13 mm
09-30-6533	43 mm	410	Double Stepped Barbed 9 mm / 13 mm
09-30-6550	45 mm	410	Double Stepped Barbed 9 mm / 13 mm
09-30-6562	70 mm	410	Double Stepped Barbed 9.5 mm / 13 mm
09-30-6560	70 mm	410	Barbed 13 mm
09-30-6561	70 mm	410	Barbed 9.5 mm



Double Stepped Barbed

Barbed with Bottom Draw-Off Tube Exit Ports



- For back packs, carboys and drums
- Cap fits large volume containers 20 liters or larger
- Cap is designed for use in an upright position and not gravity fed systems
- Barb on exit port is designed to attach large diameter flexible tubing to the outside diameter of the stem for dispensing by an instrument or pump system. The tubing is secured with a single reversed barb preventing accidental tube removal and eliminates the use of mechanical clamps
- Bottom draw-off tube port allows either rigid or flexible tubing to be attached on the channel's inside or outside diameter, allowing user to maintain the container in an upright position and aspirate / draw contents from the bottom of the container for rapid high volume flow
- Must be vented for continuous flow

Item	Neck Finish	Neck Height	Port Type
09-30-6548	38 mm	410	Barbed with Bottom Draw-Off Tube 12.5 mm
09-30-6552	58 mm	410	Barbed with Bottom Draw-Off Tube 9 mm
09-30-6553	58 mm	410	Barbed with Bottom Draw-Off Tube 12.5 mm
09-30-6554	63 mm	410	Barbed with Bottom Draw-Off Tube 9 mm
09-30-6555	63 mm	410	Barbed with Bottom Draw-Off Tube 12.5 mm



Barbed with Bottom Draw-Off Tube 12.5 mm



Barbed with Bottom Draw-Off Tube 9 mm



Press-In Bottle Adapters

- Used for dispensing oral liquids (medications) using a luer slip syringe or common oral syringe
- Non-vented
- Flanged for a secure fit - multiple feathered rings provide resistance on the inside diameter of bottle mouth once placed and fixed
- One-way draw off port
- Seals securely upon placement and after each individual usage with unique one-way valve
- Standard bottle cap is functional with a Press-In Bottle Adapter



Item	Product Description	UOM
04850	Press-In Bottle Adapter, 20 mm, Natural	100/Bag
04852	Press-In Bottle Adapter, 24 mm, Natural	100/Bag
04854	Press-In Bottle Adapter, 28 mm, Natural	100/Bag
04856	Press-In Bottle Adapter, 33 mm, Natural	100/Bag

ORAL MEDS™ Dispensers

The ORAL MEDS™ Dispensers offer a simple, accurate method for administering pills, liquid medications or supplements to small and large animals. ORAL MEDS™ syringe dispensers are available in 15 cc, 35 cc and 60 cc sizes, as well as an eye dropper. Packaged for display, ORAL MEDS™ Dispensers eliminate the “hit or miss” of oral feeding and medicating of animals.



Item	Product Description	UOM
10172	ORAL MEDS™ Oral Syringe, 15 cc	Each
10173	ORAL MEDS™ Oral Syringe, 35 cc	Each
10174	ORAL MEDS™ Oral Syringe, 60 cc	Each
10175	ORAL MEDS™ Eye Dropper (2/Pack)	Each

Dr. Hanson's Bullseye™ Pillgun

- Safe method for administering capsules or pills
- No breakage of medication when administering to the animal
- Unique quad tip fingers are designed to hold medication in place without worry of dropping medicant
- Dispensable instrument for clients to use when medicating a patient at home
- Constructed of low density polyethylene
- Protective finger grip guards



27586



27585

Item	Product Description	UOM
27585	Dr. Hanson's Bullseye™ Pillgun	12/Box
27586	Dr. Hanson's Bullseye™ Pillgun, Bulk	1,000/Case

The Gripper™ Pill Guns

The Gripper™ Pill Gun features a unique trigger action delivery handle which separates it from other small pill guns or bolus delivery systems. Dispensing shafts accommodate a variety of bolus or pill retention cups.

- Collet-like grip prevents pill from falling out prior to patient delivery
- Short trigger stroke for dispensing pills
- Handle may be engraved or decorated with a logo or lettering



64010

64007

Item	Product Description	UOM
64007	The Gripper™ Feline Pill Gun, 2 - 4 mm Bolus, 5.5 cm Shaft Length	Each
64010	The Gripper™ Bolus Gun, 5 - 9 mm Bolus, 16 cm Shaft Length	Each



Dura-Grip™ Vented Draw-Off Spikes

- Features ultra sharp point that pierces the stoppered seal of vaccine, biological or pharmaceutical bottles
- Retention grips securely attach to serum bottle - once the spike pierces the stopper and is affixed, the grips hold to the base of the foil bottle seal
- Duckbill breather valve provides rapid pressure relief while dispensing from a vial or serum bottle using continuous dispensing systems
- Available individually or in bulk
- Single use item



08010



08013



08016

Item	Product Description	UOM
08010	Dura-Grip™ Vented Draw-Off Spike, 20 mm with 6 mm Barb Stem, Red	Each
08013	Dura-Grip™ Vented Draw-Off Spike, 30-32 mm with 6 mm Barb Stem, Blue	Each
08016	Dura-Grip™ Vented Draw-Off Spike, 30-32 mm with 8 mm Barb Stem, Green	Each

Vented Draw-Off Spike Tube Systems

- Individually packaged
- Single use item

Item	Product Description	UOM
72620	Vented Draw-Off Spike Tube with 20 mm Vented Spike, 4 ft	Each
72630	Vented Draw-Off Spike Tube with 30 mm Vented Spike, 4 ft	Each
72621	Vented Draw-Off Spike Tube with 20 mm Vented Spike, 8 ft	Each
72631	Vented Draw-Off Spike Tube with 30 mm Vented Spike, 8 ft	Each



72620



72630

Use Dura-Grip™ Vented Draw-Off Spikes & Vented Draw-Off Spike Tube Systems with Hi-Flow™ Dosing Syringes for:

- High Volume Delivery
 - Topical
 - Oral
 - Injection
- Accurate Dosing



See page 197-198 for Hi-Flow™ Dosing Syringes



Med-Eze™ Stomach Pump

- Hose connection accommodates various size stomach tubes
- Dual action, may be used to pump fluids or with accessory Suction Adapter (#76810) to extract stomach / rumen content or uterine fluid
- Durable stainless steel construction
- Easy, consistent draw and delivery
- Reduces arm and shoulder fatigue
- Each stroke delivers 335 ml



Item	Product Description	UOM
34124	Med-Eze™ Stomach Pump	Each

Silicone Stomach Tubes

Stomach tubes are used primarily with equine and bovine. It is a method used to relieve dehydration due to disease or after surgical procedures. By placing the tube in a patient's stomach and utilizing pumping or gravitational flow, one can readily deliver large volumes of fluids.

- Silicone is completely inert and resists deterioration, works well even in extreme cold weather
- Steam sterilize or wash with mild soap and water
- Attaches to the Med-Eze™ Stomach Pump to pump fluid or, if used with Suction Adapter, to extract fluids



Item	Product Description	UOM
39570	Silicone Stomach Tube, Small, 12 mm Outer Diameter (36FR), 10 ft	Each
39571	Silicone Stomach Tube, Medium, 17 mm Outer Diameter (51FR), 10 ft	Each
39572	Silicone Stomach Tube, Large, 19 mm Outer Diameter (57FR), 10 ft	Each

Pump It™ 45 **PATENTED**

The Pump It™ is a refillable, fixed dose automatic syringe system used to deliver liquid products by means of injection, oral, intranasal or topical administration. This low cost, high value semi-disposable instrument distinguishes itself from other syringes due to its versatility and unlimited options to the end user for medicant delivery.

Item	Product Description	UOM
73103	Pump It™ 45, 1 ml with 60 cc - 120 cc Bottle Holder & Luer Lock Trigger	Each
73104	Pump It™ 45, 1 ml with 60 cc - 120 cc Bottle Holder with Vaccinator Tip - INFORCE 3™ - Blue	Each
73106	Pump It™ 45, 2 ml with 60 cc - 120 cc Bottle Holder with Vaccinator Tip - INFORCE 3™ - Red	Each
73108	Pump It™ 45, 2 ml with 60 cc - 120 cc Bottle Holder & Luer Lock Trigger - Red	Each
73110	Pump It™ 45, 2 ml with 60 cc - 120 cc Bottle Holder & 1.45" Trigger - Red	Each



Oral Pump It™ **PATENTED**

The Oral Pump It™ instrument threads directly onto a plastic, glass or aluminum screw top bottle with neck finish sizes of 28, 33, 38, 40 mm and is offered with a choice of 1", 1.45" and 4" trigger nozzles.

- Fixed dose, automatic and rapid delivery system
- Ideal delivery system for oral medicants, nutritionals or other supplements, as well as small dose topicals
- Semi-disposable system with superior ergonomics
- Available in variety of fixed dosage sizes:
 - ◆ 2 ml
 - ◆ 3 ml
 - ◆ 5 ml
 - ◆ 10 ml
- Bottles sold separately



73171



73151



73149



06102

Item	Product Description	UOM
73143	Oral Pump It™ 10 ml with 1.45" Trigger & 28 mm Neck Finish	Each
73144	Oral Pump It™ 10 ml with 1.45" Trigger & 38 mm Neck Finish	Each
73149	Oral Pump It™ 2 ml with 1.45" Trigger & 38 mm Neck Finish	Each
73150	Oral Pump It™ 2 ml with 1.45" Trigger & 28 mm Neck Finish	Each
73151	Oral Pump It™ 2 ml with 1" Trigger & 28 mm Neck Finish	Each
73152	Oral Pump It™ 2 ml with 1" Trigger & 38 mm Neck Finish	Each
73167	Oral Pump It™ 10 ml with 1" Trigger & 28 mm Neck Finish	Each
73168	Oral Pump It™ 10 ml with 1" Trigger & 38 mm Neck Finish	Each
73170	Oral Pump It™ 10 ml with 4" Trigger & 38 mm Neck Finish	Each
73171	Oral Pump It™ 10 ml with 4" Trigger & 28 mm Neck Finish	Each
73176	Oral Pump It™ 2 ml with 4" Trigger & 38 mm Neck Finish	Each
06102	Bottle 180 cc - 38 mm Threaded Neck - Clear - Screen Printed with Pump It™ Logo	2/Bag

Additional sizes available. Call for more information.

Oral Pump It™ Modular **PATENTED**

- Available tip options include: Luer Lock, 1" oral, 1.45" oral and 4" oral
- Fastens to most 28 mm screw top bottles
- Unique venting system allows viscous product to be easily dispensed
- Lightweight
- Easy to clean with mild soap and warm water

Item	Product Description	UOM
73125BL	Oral Pump It™ Modular 1 ml with Luer Lock Tip & 28 mm Neck Finish - Blue	Each
73126BL	Oral Pump It™ Modular 1 ml with 1" Tip & 28 mm Neck Finish - Blue	Each
73127BL	Oral Pump It™ Modular 1 ml with 1.45" Tip & 28 mm Neck Finish - Blue	Each
73128BL	Oral Pump It™ Modular 1 ml with 4" Tip & 28 mm Neck Finish - Blue	Each
73150RD	Oral Pump It™ Modular 2 ml with 1.45" Tip & 28 mm Neck Finish - Red	Each
73151RD	Oral Pump It™ Modular 2 ml with 1" Tip & 28 mm Neck Finish - Red	Each
73158RD	Oral Pump It™ Modular 2 ml with Luer Lock Trigger & 28 mm Neck Finish - Red	Each
73177RD	Oral Pump It™ Modular 2 ml with 4" Tip & 28 mm Neck Finish - Red	Each



73127BL

73150RD



Oral Pump It™ Modular



Item	Product Description	UOM
73125BL	Oral Pump It™ Modular 1 ml with Luer Lock Tip & 28 mm Neck Finish - Blue	Each
73158RD	Oral Pump It™ Modular 2 ml with Luer Lock Tip & 28 mm Neck Finish - Red	Each



Draw-Off Pump It™

The Draw-Off Pump It™ is designed to deliver vaccines and biologics in fixed dosage volumes.

The draw-off feature offers flexible tubing with vented spike.

- Ideal system for injection and intranasal delivery
- Fixed dose; automatic and rapid system
- Vented spike attaches to bottle or back pack with flexible tubing then attaches to the Pump It™
- Semi-disposable system with superior ergonomics
- Available in two fixed dosage sizes 1 ml and 2 ml

Item	Product Description	UOM
73005BL	Draw-Off Pump It™, 1 ml with Luer Lock Tip - Blue	Each
73010RD	Draw-Off Pump It™, 2 ml with Luer Lock Tip - Red	Each
73011RD	Draw-Off Pump It™, 2 ml with 1.45" Oral Tip - Red	Each



TIP

1. Place bottle of medicant on an even surface.
2. Place the Pump It™ receiver on the bottle and secure tightly.
3. Invert so the bottom of the bottle points upward.
4. Actuate trigger to dispense product.



Spray Tip Applicators

The luer lock Spray Tip Applicators are offered in various lengths for use on a surface, in a wound, cavity, canal or nostril. All devices are produced to create specific spray patterns when a syringe is compressed or a repeatable dispensing instrument is utilized. Each tip has a specific particle size when actuated due to the variable configuration of the exit port.

Item	Product Description	UOM
73820	Spray Tip Applicator, 2" Flexible	10/Bag
73823	Spray Tip Applicator, 6" Flexible	10/Bag
73825	Spray Tip Applicator, Dome	10/Bag
73827	Spray Tip Applicator, Mist	10/Bag

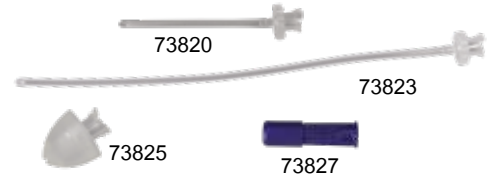

SpinStir™ GENESIS INSTRUMENTS

The SpinStir™ is a stock solution stirring unit designed to keep powder in suspension used in metered dosing through standard water lines. This system improves dispersion of solution reducing product waste. The 12-Volt DC motor, with adjustable speed control, allows user to adjust rotation speed of the stirring magnet.

- Capable of holding a 5-gallon pail up to a 50-gallon drum

Item	Product Description	UOM
77500	SpinStir™ Complete (11" L x 11" W x 5" H)	Each
77501	SpinStir™ Complete, Large (Special Order) (20" L x 16" W x 6" H)	Each



SpinStir™ Accessories		
Item	Product Description	UOM
05-317-0000	Stirring Magnet, 2-1/2"	Each
05-26-7883	Stirring Magnet, 6"	Each
05-11-010	5-Gallon Plastic Pail	Each

HAVE YOU 'HERD' ABOUT OUR BRAND NEW WEBSITE?



Visit

maianimalhealth.com

to browse all of our products.



Select Doser™ Water Medicant Dosing System

The Select Doser™ product line offers proportional additive pumps ideal for agricultural and industrial operations to accurately dispense vaccines, medications, vitamins, sanitizers and other solutions into low or high pressure watering systems. Using a Dosing Solutions operating program, the Select Doser™ customizable pumps have a unique advantage over other water medicators on the market. The Select Doser™ can be programmed to dose at any ratio from 1:10 down to 1:100,000 or deliver product in parts per million (ppm).

Design

The Select Doser™ includes built-in Dosing Solutions control software and durable industry leading motors / pumps. Unlike many pumps on the market that corrode overtime, the Select Doser™ is corrosion resistant. The peristaltic pump design prevents aggressive products from contacting the working parts of the pump. This action also prevents dangerous cross contamination and product backflow.

On-Screen Menu

In addition to up-to-the-minute data on waterflow, the on-screen menu allows the operator to select custom settings including meter only feature, dosing ratio selection, sensor selection, custom ratio adjustment, priming option and water consumption total.

Accurate

Through peristaltic action, the Select Doser™ yields precise water-to-product ratios with over 95% ACCURACY. The accuracy of the unit prevents overdosing – saving the user money and resulting in fewer health problems in livestock operations. Accuracy means faster gains!

Low Maintenance

NO Seals, NO Valves and NO Springs to replace. Just change the pump tube!

Industries Served

The Select Doser™ is used in a variety of industries including animal health, agriculture, horticulture and pH control.



Select Doser™ 380

The Select Doser™ 380 incorporates a powerful pump and Dosing Solutions programming to provide a reliable and hassle-free performance.

Technical Data:

- Weight: 2.6 lbs
- Dose Configuration: Ratio or Parts Per Million (ppm)
- Range of Ratios: 1:10 - 1:100,000
- Pressure: 80 psi Max
- Power: 12V DC via Power Supply, Solar or Battery
- Dose Interval: 5 seconds
- Available Pump Tubes:
 - ◆ Tube H - 1.24 x Ratio = Max Water Flow (gal/hr)
 - ◆ Tube F - .222 x Ratio = Max Water Flow (gal/hr)
- Delivery Lines: PVC Tubes

Item	Product Description	UOM
05-02-0045	Select Doser™ 380, Unit Only	Each
05-02-0046	Select Doser™ 380 Install Kit	Each
05-02-0027	#2 Sensor Assembly (3/4"), Max / 380 for Select Doser™ 380	Each
05-02-0028	#3 Sensor Assembly (1-1/4"), Max / 380 for Select Doser™ 380	Each





Select Doser™ 640

The Select Doser™ 640 combines a heavy-duty motor and Dosing Solutions programming to provide an exceptional and precise performance.

Technical Data:

- Weight: 2.6 lbs
- Dose Configuration: Ratio or Parts Per Million (ppm)
- Range of Ratios: 1:10 - 1:100,000
- Pressure: 32 psi Max
- Power: 12V DC via Power Supply, Solar or Battery
- Dose Interval: 5 seconds
- Available Pump Tube:
 - ◆ Purple - 8.5 x Ratio = Max Water Flow (gal/hr)
- Delivery Lines: PVC Tubes

Tip:

Remember to check pump tubes regularly for wear.

Never run the **Select Doser™ 640** into water lines with pressure greater than 32 psi.



Item	Product Description	UOM
77002	Select Doser™ 640, #2 Sensor (VTY-10, 3/4")	Each
77003	Select Doser™ 640, #3 Sensor (VTH-25, 1-1/4")	Each
05-02-0026	Select Doser™ 640 Brainbox	Each

Select Doser™ MAX



The Select Doser™ MAX combines a Stenner Company pump and Dosing Solutions operating program, creating an exceptional product.

Technical Data:

- Weight: 9 lbs
- Dose Configuration: Ratio or Parts Per Million (ppm)
- Range of Ratios: 1:10 - 1:100,000
- Pressure: 100 psi Max
- Power: 12V DC Main Control Unit; 120V AC Motor/Pump
- Dose Interval: 20 seconds
- Available Pump Tubes:
 - ◆ Tube 1 - .21 x Ratio = Max Water Flow (gal/hr)
 - ◆ Tube 2 - .71 x Ratio = Max Water Flow (gal/hr)
 - ◆ Tube 7 - 1.61 x Ratio = Max Water Flow (gal/hr)
- Delivery Lines: PVC Tubes



Item	Product Description	UOM
77200	Select Doser™ MAX with 3/4" Flow Sensor	Each
77205	Select Doser™ MAX with 1-1/4" Flow Sensor	Each
77206	Select Doser™ MAX with 2" Paddle Flow Sensor	Each
05-55-0040	Select Doser™ MAX Brainbox with Pump	Each

Tip:

When dosing harsh chemicals, **cover stock solution** and place a few feet from the pump.



Select Doser™ Accessories		
Sensors & Sensor Assemblies		
77210	3/4" Flow Sensor Assembly, Stenner Injection Port	Each
77215	1-1/4" Flow Sensor Assembly, Stenner Injection Port	Each
05-26-7802	#2, 3/4" Flow Sensor	Each
05-26-7803	#2, 3/4" Flow Sensor Assembly	Each
05-26-7804	#3, 1-1/4" Flow Sensor	Each
05-26-7805	#3, 1-1/4" Flow Sensor Assembly	Each
05-55-0037	1.5" Paddle Sensor	Each
05-55-0027	2" Paddle Sensor	Each
05-55-0028	3" Paddle Sensor	Each
Pump Tubes & Rollers		
05-02-0007	Stenner Pump Tube #1	Each
05-02-0018	Stenner Pump Tube #2	Each
05-02-0008	Stenner Pump Tube #5	Each
05-02-0009	Stenner Pump Tube #7	Each
05-02-0043	Pump Tube, Stenner F	Each
05-02-0044	Pump Tube, Stenner H	Each
05-60-0016	Pump Tube Assembly - Purple	Each
05-02-0019	Pump Tube Assembly - Purple	12/Bag
05-212-0008	Roller Assembly, Stenner - Clear	Each
05-212-0012	Rollers, Select Doser™ 640	Each
05-212-0013	Roller Assembly, Stenner, Quick-Pro	Each
05-212-0037	Roller Assembly, Stenner - White	Each
05-212-0038	Roller Assembly, Stenner - Black	Each
Miscellaneous Parts		
05-211-0029	1/4" Ferrules, Stenner	Each
05-211-0028	Connecting Nuts, 1/4" Tubing, Stenner	Each
05-210-0024	Stenner Check Valve, Duckbill	Each
05-210-0025	Injection Port with Duckbill, Stenner	Each
05-26-7105	Injection Port, 3/4" Water Line	Each
05-212-0009	Weighted Line Strainer, Stenner	Each
05-212-0005	Stenner Pumphead with Quick Pro Rollers with #7 Tube	Each
05-240-0021	Tubing, 5/32" x 1/4" x 20' PVC	Each
05-06-720	Hose Barb, 3/16"	Each
05-05-157	Check Valve, 3/16"	Each
05-60-0018	Check Valve Assembly, Gray Quick Disconnect	Each
05-211-0024	Quick Fit Male Connector, CPC	Each
05-211-0025	Quick Fit Female Connector, CPC	Each
77081	12-Volt DC Power Supply for Select Doser™ MAX	Each
05-165-0001	12-Volt DC Power Supply for Select Doser™ 380 & Select Doser™ 640	Each



LectraVet™ Injection System **PATENTED**

- Battery driven electric vaccinator designed for high volume animal processing with reliable and consistent dosage delivery
- With recent improvements, LectraVet™ is proven to be a consistent and reliable vaccine and medicant delivery instrument for treating animals in high volume and confinement operations
- Useful with swine, cattle, poultry and any livestock handling operations
- Electronics provide users with consistent and reliable systems and counts, as well as storage information
- The injection heads have a standard luer lock to accommodate off the shelf 3/8" and 1/2" standard perforator needles
- High quality precision instrument requires user awareness for proper care and maintenance
- LectraVet™ has evolved into a highly reliable instrument that performs to expectations of value, reliability and superior performance



Item	Product Description	UOM
71000	LectraVet™ Injection System	Each

LectraVet™ Accessories

Injection Heads		
05-70-2888	LectraVet™ Injection Head, 2.5 cc	Each
05-70-2915	LectraVet™ Injection Head, 5.0 cc	Each
Pistons		
05-70-4712	LectraVet™ Piston, 2.5 cc	Each
05-70-4713	LectraVet™ Piston, 5.0 cc	Each
71046	LectraVet™ Holster	Each
Miscellaneous Parts		
05-70-5001	Hanging Vial Mount Holder, 250 ml	Each
05-70-3829	LectraVet™ Line Feed Mount	Each
05-70-3821	LectraVet™ Vial Feed Bottle Holder	Each
71034	Battery Pack for LectraVet™	Each
71037	18-Volt Battery Charger for LectraVet™	Each
08010	Dura-Grip™ Vented Draw-Off Spike, 20 mm with 6 mm Barb Stem, Red	Each
08013	Dura-Grip™ Vented Draw-Off Spike, 30-32 mm with 6 mm Barb Stem, Blue	Each
07817	Transfer Spike with Identical Length Spikes & Dual Port Tips	Each

1. Select the appropriate needle length for the application
2. Select the dosage (0.25 or 5.0 cc) on the electronic control panel (dosage increment dependent on selected head attachment)
3. Place the nose shield against the desired injection site (Figure 1)
4. Press instrument down against injection site to retract the nose shield; the needle will penetrate the skin (Figures 2 & 3)
5. Pull instrument trigger to initiate injection

HOW DOES THE LECTRAVET™ WORK?

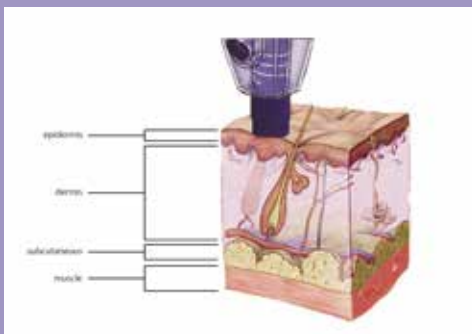

Figure 1

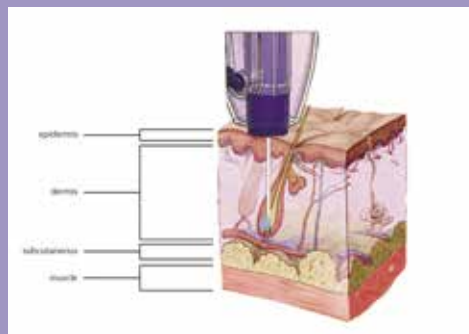

Figure 2

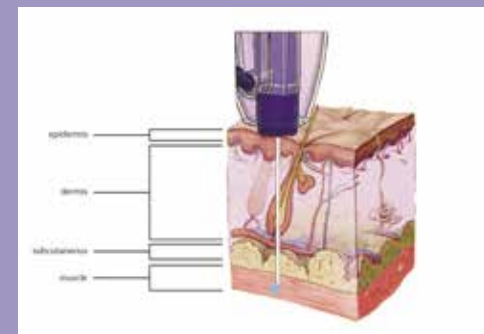

Figure 3



Power Doser™ Instruments & Accessories



PATENTED

The Power Doser™ system offers a pneumatic handheld delivery system that can be utilized with all livestock medication needs. The Power Doser™ is powered by air or CO₂ and delivers an accurate and consistent dose whether the application is injection, intranasal spray, oral drenching or pour-on. Various inlet diameters are available to accommodate different viscosities of dispensed product.

- Includes:
 - ◆ Luer Lock Needle Mount, Black, Plastic
 - ◆ Nozzle, Short Pour-On, Black, Plastic
 - ◆ Spare Parts Kit for Power Doser™
 - ◆ Nozzle Repair Kit for Power Doser™

Item	Product Description	UOM
70102	Power Doser™, 2 ml - includes 20 mm & 30 mm VDO Spike Tube	Each
70110	Power Doser™, 10 ml - includes 20 mm & 30 mm VDO Spike Tube	Each
70115	Power Doser™, 30 ml - includes 20 mm & 30 mm VDO Spike Tube	Each
70120	Power Doser™, 60 ml	Each
70130	Power Doser™, 100 ml	Each
70140	Power Doser™, 150 ml	Each



70102 with Luer Lock Needle Mount

70110 with Nozzle, Short Pour-On

Air Accessories

Item	Product Description	UOM
71500	CO ₂ Kit for Power Doser™ - Regulator, Tank, 3' Air Hose, Belt & Hip Pouch	Each
70882	CO ₂ Tank for Power Doser™	Each
70530	Air Hose, 10 ft	Each
70884	Belt, Polyester Web, 2-1/4" Wide - Brown	Each
70885	Pouch for CO ₂ Tank - Black	Each
70885-1	Pouch for CO ₂ Tank - Olive Green with Black Leg Strap	Each



71500

Barrels for Power Doser™ Instruments

Item	Product Description	UOM
40660	Barrel for Power Doser™, 2 ml	Each
40662	Barrel for Power Doser™, 10 ml	Each
40664	Barrel for Power Doser™, 30 ml	Each
40666	Barrel for Power Doser™, 60 ml	Each
70818	Barrel for Power Doser™, 100 ml	Each
70820	Barrel for Power Doser™, 150 ml	Each



Tip:

Always clean instruments after use with warm soapy water then rinse with warm water.
Lubricate O-rings with petroleum jelly or mild lubricant without alcohol.



Nozzles for Power Doser™, Air-O-Matic™, Hi-Flow™, Hi-Flow™ Plus & V-Grip™ Instruments

Item	Product Description	UOM
Pour-On Nozzles		
70870	Nozzle, Short Pour-On, Black, Plastic	Each
70872	Nozzle, 14" Pour-On Wand, Stainless Steel	Each
Drench Nozzles		
70855	Nozzle, Piglet Drench, Stainless Steel	Each
70857	Nozzle, Sheep Drench, Stainless Steel	Each
70858	Nozzle, Short Cattle Drench, Stainless Steel	Each
70859	Nozzle, Long Cattle Drench, Stainless Steel with .147" Inside Diameter	Each
70860	Nozzle, Long Cattle Drench, Stainless Steel with .280" Inside Diameter	Each
70875	Nozzle, Hook, Short Cattle Drench, Stainless Steel	Each
70876	Nozzle, Hook, Long Cattle Drench, Stainless Steel	Each
70877	Nozzle, Floating Cattle Hook with Tubing, Stainless Steel	Each
70878	Nozzle, 90 Degree Bend, Stainless Steel	Each
Needle Mount Nozzles		
70830	Luer Lock Needle Mount, Black, Plastic	Each
70831	Luer Lock Needle Mount, Stainless Steel	Each
T-Bar Nozzle		
70865	Nozzle, T-Bar with Insert, 1.2 mm	Each



Service & Repair Kits for Power Doser™ Instruments

Item	Product Description	UOM
70500	Spare Parts Kit for Power Doser™ 2 ml, 10 ml, 30 ml & 60 ml	Each
70501	Nozzle Repair Kit for Power Doser™ & Hi-Flow™ 2 ml, 10 ml, 30 ml & 60 ml	Each
70502	Spare Parts Kit for Power Doser™ 100 ml & 150 ml	Each
70503	Nozzle Repair Kit for Power Doser™ 100 ml & 150 ml	Each
05-06-252	Trigger Valve	Each
05-06-250	Brass Trigger	Each



Air-O-Matic™



PATENTED

- Air / gas powered delivery instrument provides ease in use and delivery for small flocks and herds
- Two dose adjustable sizes:
 - ◆ 0 - 15 ml
 - ◆ 0 - 30 ml
- Quick tip hose attachments
- Inflow hose barb securely affixes tubing to an Air-O-Matic™ from medicant container
- Fits all nozzle configurations including oral, topical and injectable
- Reliable, simple and economical air / gas powered system for medicant delivery
- Semi-disposable system
- Includes:
 - ◆ #70830 Luer Lock Needle Mount, Black, Plastic
 - ◆ #70870 Nozzle, Short Pour-On, Black, Plastic



Item	Product Description	UOM
70406	Air-O-Matic™, 15 ml	Each
70410	Air-O-Matic™, 30 ml	Each

Hi-Flow™ Dosing Syringes



- Improved ergonomics with soft touch grips
- Simple accurate dose adjustment
- Changeable nozzles for oral, topical and injection applications
- Available in dose adjustable sizes:
 - ◆ 0 - 12 ml
 - ◆ 0 - 30 ml
 - ◆ 0 - 60 ml
 - ◆ 0 - 75 ml
- Choice of multiple nozzles for topical, oral and vaccination for food producing animals:
 - ◆ Rapid changeover from one nozzle to another
 - ◆ Common fitments between barrel sizes and other Genesis dispensing instruments
- All nozzles fit onto Power Doser™, Air-O-Matic™, Hi-Flow™, Hi-Flow™ Plus and V-Grip™ instruments
- Easy to clean with mild soap and warm water
- Includes:
 - ◆ #70830 Luer Lock Needle Mount, Black, Plastic
 - ◆ #70870 Nozzle, Short Pour-On, Black, Plastic
 - ◆ 4 ft Tubing



Item	Product Description	UOM
66300BK	Hi-Flow™ 12 ml with 4 mm Inlet, Black	Each
66304BK	Hi-Flow™ 12 ml with 6 mm Inlet, Black	Each
66308BK	Hi-Flow™ 12 ml with 10 mm Inlet, Black	Each
66301BK	Hi-Flow™ 30 ml with 4 mm Inlet, Black	Each
66305BK	Hi-Flow™ 30 ml with 6 mm Inlet, Black	Each
66309BK	Hi-Flow™ 30 ml with 10 mm Inlet, Black	Each
66306BK	Hi-Flow™ 60 ml with 6 mm Inlet, Black	Each
66310BK	Hi-Flow™ 60 ml with 10 mm Inlet, Black	Each
66307BK	Hi-Flow™ 75 ml with 6 mm Inlet, Black	Each
66311BK	Hi-Flow™ 75 ml with 10 mm Inlet, Black	Each

Note:
All nozzles fit onto **Power Doser™**, **Air-O-Matic™**, **Hi-Flow™**, **Hi-Flow™ Plus** and **V-Grip™** instruments.



Rite-Count™

PATENTED

Rite-Count™ provides one style of biosecurity in counting exactly how many doses of any product is given to a herd, a flock or any quantity of animals whether receiving vaccines, anthelmintics or drugs being delivered orally, topically or injected. Biosecurity provides the concept of accounting for numbers treated and the quantity of product used.

Rite-Count™ provides another dimension to the biosecurity of an operation which we brand Bio-Assurity. Counting the number of doses given is a very significant and valid detail all producers should be concerned about in daily operations. The key factor with Bio-Assurity is the confirmation the correct volume of a drug or biologic delivered equates to the total animals treated. With any fixed dose regiment, the count of animals treated multiplied by the total volume delivered per actuation of Rite-Count™ equates to the total volume used. This provides assurance that all animals were treated and the correct volume of medicant has been delivered.

Biosecurity relates to container and user integrity while animals are prepared and treated, while Bio-Assurity is the assurance of accounting for all aspects of operational detail including:

- Number of animals treated
- Volume of product used / consumed
- Cost per dose of product consumed
- Total expense and cost per animal

Item	Product Description	UOM
66330	Rite-Count™	Each

Hi-Flow™ Plus Dosing Syringes (Rite-Count™ included)

PATENTED

The unique Rite-Count™ counting device is attached to the standard Hi-Flow™ instrument.

- Counter automatically counts doses dispensed and is a management tool assuring accurate dosage per delivery
- Audible sound identifies a proper dose is delivered
- Available in dose adjustable sizes:
 - ◆ 0 - 12 ml
 - ◆ 0 - 30 ml
- Variety of nozzles
- Enhance dose settings
- Counter is easily detached from instrument and refitted or replaced
- Counters may be affixed or retrofitted to an existing Hi-Flow™ which may be performed initially at our facilities
- Counters may be reconditioned and are recommended to be returned for annual maintenance
- Includes:
 - ◆ #70857 Nozzle, Sheep Drench, Stainless Steel
 - ◆ #70865 Nozzle, T-Bar with Insert, 1.2 mm
 - ◆ 4 ft Tubing



Item	Product Description	UOM
66336BK	Hi-Flow™ Plus, 12 ml with 4 mm Inlet, Black	Each
66340BK	Hi-Flow™ Plus, 12 ml with 6 mm Inlet, Black	Each
66350BK	Hi-Flow™ Plus, 12 ml with 10 mm Inlet, Black	Each
66338BK	Hi-Flow™ Plus, 30 ml with 4 mm Inlet, Black	Each
66342BK	Hi-Flow™ Plus, 30 ml with 6 mm Inlet, Black	Each
66352BK	Hi-Flow™ Plus, 30 ml with 10 mm Inlet, Black	Each



V-Grip™ Dosing Instruments GENESIS INSTRUMENTS

- Redesign and reconfiguration of a reliable and inexpensive medicant delivery instrument with a V-handle drive
- All nozzles used for Power Doser™, Air-O-Matic™, Hi-Flow™, Hi-Flow™ Plus and instruments fit readily onto the new V-Grip™ design and are interchangeable
- Ideal for small flocks or herds
- Used for oral, topical and injection
- Automatic refill of barrel after contents are dispensed
- Available in dose adjustable sizes:
 - ◆ 0 - 6 ml - for oral and injection delivery only
 - ◆ 0 - 15 ml
 - ◆ 0 - 30 ml
- Reliable and consistent medicant delivery in a simple instrument with minimal parts
- Includes: #70830 Luer Lock Needle Mount, Black, Plastic, #70870 Nozzle, Short Pour-On, Black, Plastic and 4 ft Tubing



Item	Product Description	UOM
66020	V-Grip™ Dosing Instrument, 6 ml	Each
66022	V-Grip™ Dosing Instrument, 15 ml	Each
66024	V-Grip™ Dosing Instrument, 30 ml	Each

Nozzles for Power Doser™, Air-O-Matic™, Hi-Flow™, Hi-Flow™ Plus & V-Grip™ Instruments

Item	Product Description	UOM
Pour-On Nozzles		
70870	Nozzle, Short Pour-On, Black, Plastic	Each
70872	Nozzle, 14" Pour-On Wand, Stainless Steel	Each
Drench Nozzles		
70857	Nozzle, Sheep Drench, Stainless Steel	Each
70858	Nozzle, Short Cattle Drench, Stainless Steel	Each
70859	Nozzle, Long Cattle Drench, Stainless Steel with .147" Inside Diameter	Each
70860	Nozzle, Long Cattle Drench, Stainless Steel with .280" Inside Diameter	Each
70875	Nozzle, Hook, Short Cattle Drench, Stainless Steel	Each
70876	Nozzle, Hook, Long Cattle Drench, Stainless Steel	Each
70877	Nozzle, Floating Cattle Hook, Stainless Steel	Each
70878	Nozzle, 90 Degree Bend, Stainless Steel	Each
Needle Mount Nozzles		
70830	Luer Lock Needle Mount, Black, Plastic	Each
70831	Luer Lock Needle Mount, Stainless Steel	Each
T-Bar Nozzle		
70865	Nozzle, T-Bar with Insert, 1.2 mm	Each



USE ALL OF THESE NOZZLES
On all of these products!



Phoenix™ Dosing Instrument **PATENTED**

The Phoenix™ Dosing Instrument is a dose adjustable inexpensive simple medicant delivery system.

- V-handle drive for delivery of medicants; oral or topical delivery
- Automatic refill of medicants from 0 - 30 ml doses
- Dose adjustable volumes are consistent once volume is set
- Durable, reusable system with minimal number of parts
- Nozzles are specific to the Phoenix™ Dosing Instrument for oral or topical delivery
- Includes: Pour-On Nozzle and 4 ft Tubing



Item	Product Description	UOM
66124	Phoenix™ Dosing Instrument, 30 ml	Each

Palm Grip™

The rugged Palm Grip™ is manufactured using high quality materials and is designed for longevity. It is made from a combination of machined and cast stainless steel components with plastic molded grips on the instrument body and trigger. Ergonomically designed to fit comfortably in the hand. The upward piston design offers less stress to the hand and wrist.

- Accurate, multi-dose vaccinator
- Simple maintenance and minimal replacement parts
- Easy to disassemble and clean
- Dose adjustable
- Provided with standard Draw-Off Tube or bottle holder

Palm Grip™ with Draw-Off Tube

Item	Product Description	UOM
73500	Palm Grip™ 0.1 - 1.0 ml Multi-Dose Vaccinator	Each
73505	Palm Grip™ 1 - 5 ml Multi-Dose Vaccinator	Each



73505

Palm Grip™ Accessories		
73800	Spare Parts Kit (for #73500)	Each
73805	Spare Parts Kit (for #73505)	Each
72620	Vented Draw-Off Spike Tube with 20 mm Vented Spike, 4 ft	Each
72630	Vented Draw-Off Spike Tube with 30 mm Vented Spike, 4 ft	Each
72621	Vented Draw-Off Spike Tube with 20 mm Vented Spike, 8 ft	Each
72631	Vented Draw-Off Spike Tube with 30 mm Vented Spike, 8 ft	Each

Palm Grip™ with Bottle Holder

Item	Product Description	UOM
73508	Palm Grip™ 1 - 5 ml Multi-Dose Vaccinator, Plastic Head with 60 cc Bottle Holder	Each
73510	Palm Grip™ 1 - 5 ml Multi-Dose Vaccinator, Plastic Head with 120 cc Bottle Holder	Each



73510

Medi-Cartridge™ Applicator Gun

The applicator gun used universally throughout the industry for dispensing 300 ml cartridges.

- Cost effective, accurate and consistent dose delivery
- Rugged materials and superior construction
- Accommodates large cartridges up to 300 ml
- Bezel receiver fixed within a metal receiver head
- Delivers product in volumes ranging from 5 ml to 15 ml

Item	Product Description	UOM
04228	Medi-Cartridge™ Applicator Gun, 300 ml	Each
05810	Drench Hook Extension - for Medi-Cartridge™ Applicator Gun	Each



The Whiplash™ Complete

The Whiplash™ Complete is the superior system for delivering liquid medicants, nutritionals, electrolytes, mineral oil, bloat remedies or high volumes of fluids. The Med-Eze™ Stomach Pump is stainless steel, durable, low maintenance and delivers one liter of fluids in three strokes.

- Includes: The Whiplash™ Flexible Stainless Steel Stomach Tube, Med-Eze™ Stomach Pump and 6 ft of durable rubber hose
- Dual action, may be used to pump fluids or with accessory Suction Adapter (#76816) to extract stomach / rumen content or uterine fluid
- Flexible, stainless steel construction
- Med-Eze™ Stomach Pump reliably delivers 335 ml per stroke; three strokes deliver one liter
- Highly polished bulb has end and side exit ports
- Elongated probe completely enters rumen and allows for high volume fluid delivery
- Available in 60 inch and 80 inch lengths
- Nose clamp allows oral delivery without assistance



Item	Product Description	UOM
76000	The Whiplash™ Complete with Pump, Rubber Hose & Flexible Stainless Steel Stomach Tube, 36"	Each
76004	The Whiplash™ Complete with Pump, Rubber Hose & Flexible Stainless Steel Stomach Tube, 60"	Each
76005	The Whiplash™ Complete with Pump, Rubber Hose & Flexible Stainless Steel Stomach Tube, 80"	Each
76051	The Whiplash™ Flexible Stainless Steel Stomach Tube, 60" with Nose Lead	Each
76052	The Whiplash™ Flexible Stainless Steel Stomach Tube, 80" with Nose Lead	Each
76823	Handle Replacement for The Whiplash™ Stomach Tube	Each

Med-Eze™ Oral Delivery Pump

The universal pump for delivery of liquid nutritionals and medicants.

- Leakproof delivery pump
- Durable stainless steel construction eliminates corrosion
- Easy and consistent delivery of product
- Reduces arm and shoulder fatigue
- Three strokes deliver one liter
- Designed for oral delivery of drenches, fluids and nutraceuticals
- Includes: Med-Eze™ Oral Delivery Pump, 6 ft of plastic tubing and rigid plastic L-shaped oral probe



Item	Product Description	UOM
34123	Med-Eze™ Oral Delivery Pump	Each

Med-Eze™ Cart Pump

- Mobile and versatile system for high volume delivery of Up & Over™ Plus and other oral liquids or gels
- 15-gallon capacity
- Increased mobility and product capacity
- Easy and consistent delivery of product
- Durable cart with all plastic construction reservoir
- Designed for use with The Whiplash™ Flexible Stainless Steel Stomach Tube
- Also available in custom / modified versions



Item	Product Description	UOM
76010	Med-Eze™ Cart Pump	Each



Med-Eze™ Stomach Pump

- Hose connection accommodates various size stomach tubes
- Dual action, may be used to pump fluids or with accessory Suction Adapter (#76810) to extract stomach / rumen content or uterine fluid
- Durable stainless steel construction
- Easy, consistent draw and delivery
- Reduces arm and shoulder fatigue
- Each stroke delivers 335 ml



Item	Product Description	UOM
34124	Med-Eze™ Stomach Pump	Each

Med-Eze™ & The Whiplash™ Oral Delivery System Accessories

Item	Product Description	UOM
76814	Adapter for 1" ID Stomach Tube	Each
76810	Adapter for 5/16" - 7/16" ID Stomach Tube	Each
76812	Adapter for 7/16" - 1" ID Stomach Tube	Each
76822	Bulb End for The Whiplash™ Stomach Tube	Each
76820	Chain for The Whiplash™ Stomach Tube with Nose Lead	Each
76100	Med-Eze™ Rubber Hose Replacement	Each
76805	Med-Eze™ Pump Piston	Each
76800	Med-Eze™ Pump Seal / Gasket Kit	Each
76807	Med-Eze™ Pump Housing with Screws	Each
76816	Suction Adapter	Each



Silicone Stomach Tubes

Stomach tubes are used primarily with equine and bovine. It is a method used to relieve dehydration due to disease or after surgical procedures. By placing the tube in a patient's stomach and utilizing pumping or gravitational flow, one can readily deliver large volumes of fluids.

- Silicone is completely inert and resists deterioration, works well even in extreme cold weather
- Steam sterilize or wash with mild soap and water
- Attaches to the Med-Eze™ Stomach Pump to pump fluid or, if used with Suction Adapter, to extract fluids

Item	Product Description	UOM
39570	Silicone Stomach Tube, Small, 12 mm OD (36FR), 10 ft	Each
39571	Silicone Stomach Tube, Medium, 17 mm OD (51FR), 10 ft	Each
39572	Silicone Stomach Tube, Large, 19 mm OD (57FR), 10 ft	Each



Funnels

Item	Product Description	UOM
39573-4	Funnel, 4 oz	Each
39573-8	Funnel, 8 oz	Each
39573-16	Funnel, 16 oz	Each



Pour-On Dipper

The Pour-On Dipper is ideal for small farms applying pour-on pesticides or anthelmintics. Convenient measuring cup with extended handle to ensure the appropriate dosage is applied on animal's back.

- Lid provides multiple holes for distribution or application

Item	Product Description	UOM
66500	Pour-On Dipper	Each



V-Grip™ Bolus Guns

Simple dispensing bolus gun, utilizing the efficiency and economy of the V-Grip™ handles.

- Strong flexible ribs on inside of bolus cup allow for retention of various bolus sizes
- Economical delivery system
- All plastic construction, lightweight and durable
- Handle returns to open position once bolus is dispensed
- Delivers 1 - 2 boluses per actuation depending on cup size from 13 mm to 35 mm
- Shaft sizes available: 21 cm, 24 cm, 43 cm and 45 cm



Item	Product Description	UOM
64310	V-Grip™ Bolus Gun, 21 cm Shaft x 13 mm	Each
64311	V-Grip™ Bolus Gun, 24 cm Shaft x 19 mm	Each
64314	V-Grip™ Bolus Gun, 24 cm Shaft x 35 mm	Each
64315BK	V-Grip™ Bolus Gun, Shaft + Cup Length - 43 cm, Black Cup (ID 36 mm)	Each
64316BL	V-Grip™ Bolus Gun, Shaft + Cup Length - 43 cm, Blue Cup (ID 30 mm)	Each
64320	V-Grip™ Bolus Gun, 43 cm Shaft x 13 mm	Each
64322	V-Grip™ Bolus Gun, 45 cm Shaft x 19 mm	Each
64328	V-Grip™ Bolus Gun, 45 cm Shaft x 35 mm	Each

Numerous size cups available for all bolus sizes and configurations.

The Clicker™ Multi-Bolus Guns

A bolus gun with single piece body pistol grip design for multiple bolus delivery.

- Sturdy PVC in a pistol grip design with vinyl grips
- One inch diameter with various chamber lengths
- Stainless steel shaft push rod with threaded plastic palm end
- Plastic plunger head for administering stomach magnets, as well as standard boluses
- 2 sizes available, calf and adult



Item	Product Description	UOM
64420	The Clicker™ Multi-Bolus Gun, 19-3/4" with Grippers	Each
64426	The Clicker™ Multi-Bolus Gun, 21-3/4" without Grippers	Each

Got Bolus? TRANSITION™ Calcium Bolus

Ideal for transitioning cows post calving

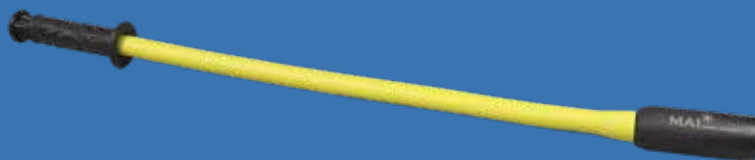

See our specially designed bolus gun for TRANSITION™ Boluses on page 204.

See page 208 for More Information.



Silver Bolus™ Balling Guns



PATENTED

Solid, high quality stainless steel construction. Manufactured for longevity and reliability.

- Smooth push rod action
- Stainless steel pistol grip handle

Silver Bolus™ Balling Gun for Large Calcium Boluses

Delivers the Transition™ Calcium Bolus (176 gram), as well as other large calcium boluses.

- Bolus protected by large 35 mm stainless steel cup
- Light bolus retention and easy release bolus delivery

Item	Product Description	UOM
64431	Silver Bolus™ Balling Gun for Large Calcium Boluses, Useable Length - 42 cm	Each



Silver Bolus™ Balling Gun for Conventional Boluses

Delivers multiple conventional sized boluses (aspirin, probiotics, etc.)

- Delivers up to eight boluses at one time
- Inside diameter 25 mm

Item	Product Description	UOM
64428	Silver Bolus™ Balling Gun for Conventional Boluses, Useable Length - 42 cm	Each



Silver Bolus™ Double Bolus Balling Gun for Transition™ Calcium Boluses

Item	Product Description	UOM
64435	Silver Bolus™ Double Bolus Balling Gun for Transition™ Calcium Boluses	Each



Extra-Flex™ Bolus Guns

The Extra-Flex™ Bolus Gun is an instrument that has a durable and flexible shaft when delivering a bolus to a patient. The Extra-Flex™ Bolus Gun cup fits a standard Transition™ Calcium Bolus that encloses the bolus in its entirety preventing a cow from chewing on the bolus end. The plunger, with a bulbous head for plunging bolus, is flexible consistent with shaft's flexibility, while a durable grip is affixed acting as the handle for the plunger to express the bolus and stop for plunger bulb.

Item	Product Description	UOM
64510	Extra-Flex™ Bolus Gun for Transition™ Bolus - Yellow	Each
64512	Extra-Flex™ Bolus Gun For Standard Bolus - Yellow	Each



The Gripper™ Bolus Guns



A small bolus gun delivery system for capsules and small diameter boluses.

- For use with cats, dogs, sheep, goats, calves and small ruminants
- Collet-like grip prevents capsule from falling out prior to patient delivery
- Short stroke in administering bolus or pills
- For use with boluses from 5 mm - 14 mm

Item	Product Description	UOM
64140	The Gripper™ Bolus Gun, 16 cm Shaft x 9.5 mm - 14 mm	Each
64100	The Gripper™ Bolus Gun, 16 cm Shaft x 5 mm - 9 mm	Each



Genesis Implant Guns **PATENTED**

Genesis Instruments provides a limited range of continuous feed, solid dose implant devices and magazines for solid dose, pellet or RFID microchip implants.

- Two implant gun sizes available:
 - ◆ Large
 - ◆ Intermediate

Large Implant Device

- 10 column magazine measuring 2.064" x 1.449"
- Manual advancement system affixed with metal collet
- Automatic expulsion of magazine after all doses are dispensed
- Large implanter available with or without stripper bar
- Durable and rugged instrument with spring-loaded trigger and retractable probe once actuated and dose delivered

Item	Product Description	UOM
72600	Large Implant Device	Each
05-24-4245	Magazine Large .154" ID	Each



Intermediate Implant Device

- 10 column magazine measuring 2.062" x 0.825"
- Continuous automatic cartridge advancement
- Automatic advancement of magazine per actuation of implant
- Continuous feed and automatic magazine expulsion after last implant column has been delivered
- Spring-loaded trigger harmonizes action of delivery and advancement
- Metal collet holds implant needle securely

Item	Product Description	UOM
72610	Intermediate Implant Device	Each
05-24-4240	Magazine Intermediate .114" ID	Each
05-24-4241	Magazine Intermediate .154" ID	Each



RFID Implanters

Genesis Microchip Implanter

- Luer lock instrument fits standard microchip loaded needles
- Ergonomic handle grip and trigger for ease of actuation
- Customization of the stroke and diameter of the loaded needle
- Available for other solid dosage implants
- Custom colors and decoration available

Item	Product Description	UOM
Call for info	Genesis Microchip Implanter	Each



Turley Implant Gun

- Stylized implanter to receive regular gauged needles with loaded 2.52 mm outside diameter microchips
- Customization available
- Lever action instrument for ease in delivery of any solid dose or microchip loaded needle system

Item	Product Description	UOM
Call for info	Turley Implant Gun	Each



Resorb Pin and Plate System

Revolutionary Technique for Osteosynthesis

The Resorb Pin and Plate System combines highly advanced ultrasound technology with resorbable implants to provide extremely stable fixation and completely eliminate the need for a second operation.

BoneWelding® Fixation

The BoneWelding® technology employs ultrasonic energy to liquefy the polymeric components of the Resorb pins at the interface with bone tissue. The liquid polymer flows into the marrow space of the surrounding cancellous bone where it is immediately quenched and provides a 3D anchorage of the implant. Thermal energy is only generated for approximately 1 second during the BoneWelding® process.

The thermal impact on the bone is minimal. The short ultrasonic impulse (1 second) and the localized liquefaction of the polymer neither disturb bone healing nor osseointegration.

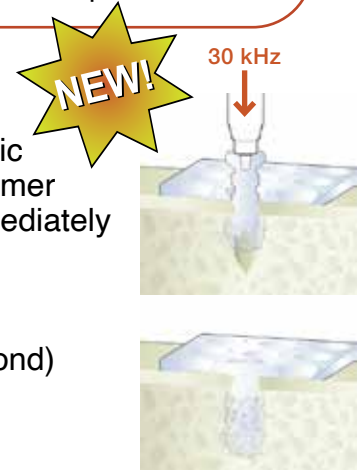

VetWelding® Resorb Pin and Plate System

The VetWelding® Resorb Pin and Plates are made of 100% biocompatible and fully bioresorbable Poly-D, L-lactic Acid (PDLLA). The in vivo degradation of the pins and plates is based on the natural physiological process of hydrolysis, which results in a complete metabolization of the polymer into H₂O and CO₂.



Pins and Plates

The pins are 2.1 mm in diameter and are provided in lengths from 4 mm to 9 mm. Plates and meshes are available in a wide variety of different shapes, sizes and thicknesses and can be easily contoured or cut with scissors intraoperatively. This ensures the right implant for every indication and easy adaptation to patient specific anatomy.

Simple Procedure

The Resorb Pin and Plate System is implanted with a simple 3 step procedure:

1. Resorbable plates or meshes are heated up in a water bath and shaped to fit the application site
2. Holes are predrilled for the pins
3. Plates are fixed in place with Resorb pins
 - Sonotrode liquefies the pins
 - Pins bond with the plate or mesh
 - Polymer penetrates the bone cavities and anchors the implant securely

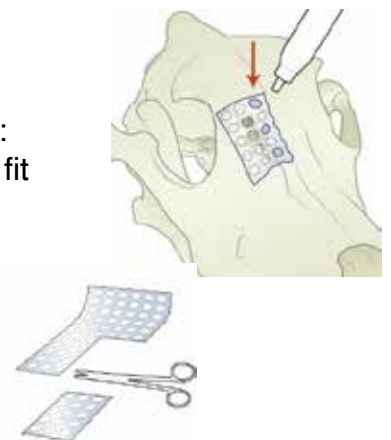

Indications

The Resorb Pin and Plate System is intended for surgical procedures in which an internal fixation by resorbable implants is required for aligning, reconstructing and stabilizing bone tissue. It is indicated for use in non-load-bearing applications.

- Treatment of maxillofacial fractures
- Laminoplasty
- Reconstruction of bone defects after cranial tumor resection
- Wound closure following equine tooth extraction for prevention of food contamination

See **page 113**
for more information!

Dr. Larson's™ Non-Irritating Calcium Gel

- Non-irritating oral calcium supplement for freshening dairy cattle
- Helps maintain normal levels of calcium in transition and close up cows
- Gel formulation with Calcium Propionate and Calcium Oxide in an oil-based gel
- Contains 100 grams of calcium per dose
- Proven to raise calcium levels in university studies
- 300 cc cartridge with super short nozzle



Item	Product Description	UOM
34110	Dr. Larson's™ Non-Irritating Calcium Gel, 300 cc Medi-Cartridge™	12/Box

Dr. Larson's™ CMPK Gel

- Unique gel blend of Calcium, Magnesium, Phosphorus and Potassium
- Cost effective nutritional aid
- Water-based formulation
- Delivers key minerals for transition cows when needed most
- 54 grams Calcium
- 2.9 grams Magnesium
- 10 grams Phosphorus
- 1 gram Potassium
- 300 cc cartridge with super short nozzle



Item	Product Description	UOM
81515	Dr. Larson's™ CMPK Gel, 300 cc Medi-Cartridge™	12/Box

Dr. Larson's™ Keto Gold™

- Suppresses ketosis problems in sick and transition cows
- Helps to maximize dry matter intake and improves production
- 235 ml Propylene Glycol
- 15 grams Niacin, 3 grams Choline
- Includes Vitamins A, D and E
- B vitamins added for appetite stimulation and to assist in fat metabolism
- 300 cc cartridge with super short nozzle



Item	Product Description	UOM
34125	Dr. Larson's™ Keto Gold™, 300 cc Medi-Cartridge™	12/Box

Dr. Larson's™ Bovine Buffer™

- Sodium bicarbonate paste designed to give quick relief to cattle with acidosis
- Adjusts rumen pH instability
- Does not cause bloat
- Proven effective in university studies
- 300 cc cartridge with super short nozzle



Item	Product Description	UOM
34100	Dr. Larson's™ Bovine Buffer™, 300 cc Medi-Cartridge™	12/Box

Dr. Larson's™ Keto Gold™ 1000

Aids in minimizing ketosis and maximizing dry matter intake and production. Keto Gold™ contains Propylene Glycol, Niacin and other vitamins essential for healthy metabolism in the postpartum cow.

- Stable suspension in an elegant gel enables easy administration
- Each 330 ml dose of Keto Gold™ provides approximately 260 ml Propylene Glycol, 17 grams Niacin, 200,000 IU Vitamin A, 75,000 IU Vitamin D3, 100 IU Vitamin E, Ascorbic Acid, Riboflavin, Pantothenic Acid, Pyridoxine, Choline and Folic Acid
- Med-Eze™ Stomach Pump delivers full dose in one stroke (335 ml / stroke)
- B vitamins added for appetite stimulation and to assist in fat metabolism
- 42 dose pail



Item	Product Description	UOM
34132	Dr. Larson's™ Keto Gold™ 1000, 14 Liter Pail	Each



Dr. Larson's™ Up & Over™ Plus

Designed to impact a dairy cow suffering from, or at risk for, milk fever, fatty liver or ketosis. A University of Idaho study shows 8.3 lbs / day milk increase during the first two weeks of lactation after use of Up & Over™ Plus. The original Up & Over™ formula plus 10 grams of Niacin per dose.

- 400 grams per dose Calcium Propionate (glucose precursor)
- 400 grams per dose Propylene Glycol
- 100 grams per dose Elemental Calcium
- 10 grams per dose Niacin
- Non-caustic - will not cause burning of the esophagus
- Increases appetite, feed consumption and milk production
- 14 dose pail
- Med-Eze™ Stomach Pump delivers full dose in three strokes (335 ml / stroke)

Item	Product Description	UOM
34111	Dr. Larson's™ Up & Over™ Plus, 14 Liter Pail	Each



Dr. Larson's™ CMPK Drench

- Use pre and post freshening to support optimum health
- Aids appetite stimulation
- Contains essential minerals and Propylene Glycol
- 200 ml per feeding

Item	Product Description	UOM
83005	Dr. Larson's™ CMPK Drench, 1 Gallon	Each



Dr. Larson's™ Niacin Drench

- Use on fresh heifers and ketotic cows
- Contains Propylene Glycol for additional energy
- Contains B vitamins to stimulate appetite
- 200 ml per feeding

Item	Product Description	UOM
83010	Dr. Larson's™ Niacin Drench, 1 Gallon	Each



Transition™ Calcium Bolus

- Available in a large 176 gram bolus containing 44 grams calcium and 50,000 IU Vitamin D
- Contains immediate release calcium and sustained release calcium plus Vitamin D which is necessary for absorption and metabolism of calcium and phosphorus
- Easier to deliver than gels and paste. The animal receives the entire dose so there is no wasted product
- Smooth coating for easy swallowing
- No withdrawal time required
- Ideal for transition cows post calving

Item	Product Description	UOM
85008	Transition™ Calcium Bolus, 176 g	6/Box
85011	Transition™ Calcium Bolus, 176 g	48/Case (8 Boxes of 6/Box)



Lactated Ringers Solution

Lactated Ringers is used for replacing fluids and electrolytes in animals who have low blood volume or low blood pressure.

Item	Product Description	UOM
22602	Lactated Ringers Solution - 1 Liter Bag	Each



Squeeze-Jet™ Dispensers & Accessories

Low density, bellow-shaped container used to package and dispense creams and liquids.

- Unique bellow container / dispenser available in five colors
- Squeeze-Jet™ includes tip and cap

Item	Product Description	UOM
02010	Squeeze-Jet™ with Cannula Tip & Cap, Natural, 30 cc	1,000/Case
02010BK	Squeeze-Jet™ with Cannula Tip & Cap, Black, 30 cc	1,000/Case
02010BL	Squeeze-Jet™ with Cannula Tip & Cap, Blue, 30 cc	1,000/Case
02010GN	Squeeze-Jet™ with Cannula Tip & Cap, Green, 30 cc	1,000/Case
02010RD	Squeeze-Jet™ with Cannula Tip & Cap, Red, 30 cc	1,000/Case
02070	Squeeze-Jet™ with Cannula Tip & Cap, Natural, 40 cc	700/Case
02072	Squeeze-Jet™ with Cannula Tip & Cap, Natural, 60 cc	550/Case



Tip:
Color code products using
Squeeze-Jet™ Dispensers!

Squeeze-Jet™ Accessories

02030	Squeeze-Jet™ Cannula Tips	1,000/Bag
02040	Squeeze-Jet™ Cannula Caps	1,000/Bag
02050	Squeeze-Jet™ Luer Slip Tips	1,000/Bag
02061	Squeeze-Jet™ Luer Lock Tips	1,000/Bag
02120	Squeeze-Jet™ Oral / Enema Tips	1,000/Bag
03010	Squeeze-Jet™ Box	250/Case
03530	Alcohol Preps, Large	100/Box

Mastitis Syringe & Cap Combinations

Use for dispensing medicants into a mammary gland.

- Used for infusion of medicants into open wounds or punctures
- Three-piece syringe includes barrel, plunger and cap
- Syringe is molded with cannula tip
- Duo-Cap™ for partial insertion of the cannula when medicating a mammary gland

Item	Product Description	UOM
02270	Genesis Mastitis Syringe, White with Cap, Vented, 15 cc	1,000/Case
02272	Genesis Mastitis Syringe, White with Duo-Cap™, Vented, 15 cc	1,000/Case
02209	Genesis Mastitis Syringe, White with Duo-Cap™, 30 cc	500/Case
02210	Genesis Mastitis Syringe, White with Cap, 30 cc	500/Case
02211	Genesis Mastitis Syringe, Red with Cap, 30 cc	500/Case
02212	Genesis Mastitis Syringe, Red with Duo-Cap™, 30 cc	500/Case



Multi-Dose™ Oral Tip Syringes - White Polyethylene

- Used for oral delivery
- Five-piece syringe includes barrel, plunger, dial, seal and cap
- Graduations on the plunger

Item	Product Description	UOM
02213	Multi-Dose™ Long Nose Oral Tip Syringe with Cap, 15 cc	50/Bag
02215	Multi-Dose™ Long Nose Oral Tip Syringe with Cap, 32 cc	50/Bag
02236	Multi-Dose™ Long Nose Oral Tip Syringe with Cap, 60 cc	50/Bag
02238	Multi-Dose™ Long Nose Oral Tip Syringe with Cap, 80 cc	50/Bag
02240	Multi-Dose™ Broad Nose Oral Tip Syringe with Cap, 120 cc	25/Bag



Syringe Filling Accessories

Item	Product Description	UOM
03015	Syringe Boxes, Bulk	250/Case
03205	Syringe Venting Tool	Each



Medi-Cartridge™ with Seal & Cap, 300 cc



Item	Product Description	UOM
02300	Medi-Cartridge™ with Seal & Cap, 300 cc, Long Nozzle	135/Case
02305	Medi-Cartridge™ with Seal & Cap, 300 cc, Short Nozzle	135/Case
02310	Medi-Cartridge™ with Seal & Cap, 300 cc, Super Short Nozzle	135/Case
05810	Drench Hook Extension for 300 cc Medi-Cartridge™	Each



MAKE A CALCULATED DECISION



Oral Supplement For Dairy Cows

More Calcium. More Palatability. More Value.



At
calving



12 hours
after calving

Choose the supplement specifically formulated for transition dairy cows. Choose **TRANSITION™ Boluses**.

TRANSITION™ Boluses are nutritional supplements for preventative treatment in close up and transition dairy cows. **TRANSITION™** Boluses are easy to administer, safe for the animal and help prepare cows to enter the milking herd in a normal time frame.

TRANSITION™ Boluses contains a unique blend of calcium for immediate and sustained release and Vitamin D3 which is necessary for the absorption and metabolism of calcium.

- ℄ Calcium chloride
- ℄ Calcium carbonate
- ℄ Calcium propionate

Vitamin D3 is also introduced to help the absorption and metabolism of calcium and phosphorus.

TRANSITION™ Bolus

SEE PAGE 208



Genesis Industries manufactures specialty Vented and Non-Vented Draw-Off Caps. All Genesis Draw-Off Caps are made of high density polyethylene for impact resistance. The caps have an outside diameter ribbed for a secure grip when sealing the cap onto the container or removing after use.

Features of Draw-Off Caps:

- An internal recess on the cap's inside face to accept tubing which may be used to remove container contents without inverting the container
- An expansion ring on the inside diameter of the cap face. The ring engages against the inside diameter of the container as the cap is threaded into position sealing the cap securely to the bottle preventing the potential for leakage when the container is inverted
- Various exit port configurations are offered to accommodate different methods of aspiration or gravitational feeding from a bottle or container
- Available vented or non-vented. Vented caps for continuous flow will equalize the pressure of container contents whereas non-vented caps will not
- All Oral Draw-Off and Luer Lock Ports may be sealed with specific caps attached by lanyards to meet customer requirements
- May be custom manufactured to meet customer's needs / specifications, including custom colors

Luer Lock Draw-Off Caps



- Designed to fit any luer lock syringe
- Exit port sealed with Luer Lock Cap is attached with a fixed lanyard - avoiding loss of cap. Capped exit ports provide security of contents when not in use
- Vented or non-vented:
 - ◆ Inverted: utilizes gravity feed without a stem to deliver contents
 - ◆ Upright: utilizes a stem from cap's inner surface to draw contents
- Draw-Off Caps are stocked in two colors. Please specify Black (BK) or White (WH) after item number
- Custom colors are also available



Luer Lock Port with Cap & Strap



Item	Neck Finish	Neck Height	Port Type
09-30-6519	20 mm	410	Luer Lock Port with Cap & Strap
09-30-6513	24 mm	410	Luer Lock Port with Cap & Strap
09-30-6518	24 mm	415	Luer Lock Port with Cap & Strap
09-30-6521	28 mm	410	Luer Lock Port with Cap & Strap
09-30-6522	33 mm	400	Luer Lock Port with Cap & Strap
09-30-6531	38 mm	400	Luer Lock Port with Cap & Strap
09-30-6523	38 mm	410	Luer Lock Port with Cap & Strap

Luer Slip & Genesis Oral Syringe Draw-Off Caps



- Exit port inside diameter fits any luer slip syringe for aspiration of the container contents
- Exit port outside diameter fits a Genesis Oral B15 Syringe Tip or equivalent configuration
- Vented or non-vented:
 - ◆ Inverted: utilizes gravity feed without a stem to deliver contents
 - ◆ Upright: utilizes a stem from cap's inner surface to draw contents
- Exit port sealed with B15 Cap is attached with a fixed lanyard - avoiding loss of cap. Capped exit ports provide security of contents when not in use
- Draw-Off Caps are stocked in two colors. Please specify Black (BK) or White (WH) after item number
- Custom colors are also available



Oral Draw-Off Port

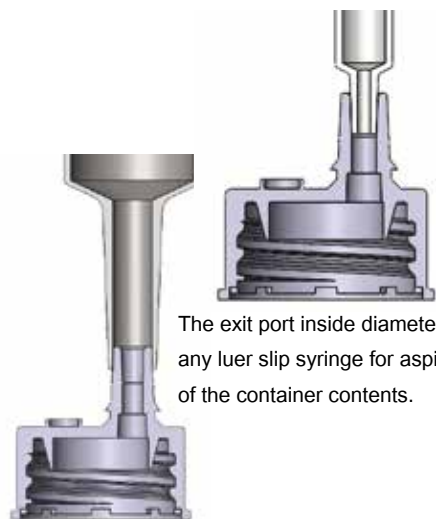

The exit port inside diameter fits any luer slip syringe for aspiration of the container contents.

Item	Neck Finish	Neck Height	Port Type
09-30-6602	20 mm	410	Oral Draw-Off Port without Vent with Cap & Strap
09-30-6604	24 mm	410	Oral Draw-Off Port without Vent with Cap & Strap
09-30-6512	28 mm	410	Oral Draw-Off Port with Cap & Strap
09-30-6529	38 mm	400	Oral Draw-Off Port with Cap & Strap
09-30-6537	38 mm	410	Oral Draw-Off Port with Cap & Strap
09-30-6535	45 mm	410	Oral Draw-Off Port with Cap & Strap
09-30-6681	45 mm	410	Oral Draw-Off Port without Vent with Cap & Strap

The exit port outside diameter fits a Genesis Oral B15 Syringe Tip or equivalent configuration.



Ribbed & Double Stepped Ribbed Exit Ports



- Designed to accommodate variable tubing diameter on the exit port depending on the customers' application
- Stepped & ribbed ports are designed and ideal to affix a mechanical clamp to any tubing diameter assembly fitted to the exit port for security
- Vented or non-vented:
 - ◆ Inverted: utilizes gravity feed without a stem to deliver contents
 - ◆ Upright: utilizes a stem from cap's inner surface to draw contents

Item	Neck Finish	Neck Height	Port Type
09-30-6511	33 mm	410	Ribbed 9 mm
09-30-6515	38 mm	410	Ribbed 9 mm
09-30-6520	38 mm	410	Ribbed 13 mm
09-30-6551	45 mm	410	Ribbed 13 mm
09-30-6534	38 mm	410	Double Stepped Ribbed 9 mm / 13 mm
09-30-6514	24 mm	410	Stepped Adapter
09-30-6525	38 mm	400	Stepped Adapter
09-30-6527	38 mm	410	Stepped Adapter



Ribbed 13 mm



Double Stepped Ribbed

Barbed & Double Stepped Barbed Exit Ports



- Designed to accommodate, affix and secure variable tubing diameters to the exit port depending on the customers' application. The tubing is secured with reverse barbs preventing accidental tube removal and eliminates the use of mechanical clamps
- Contents may be dispensed using any instrument that aspirates and dispenses
- Vented or non-vented:
 - ◆ Inverted: utilizes gravity feed without a stem to deliver contents
 - ◆ Upright: utilizes a stem from cap's inner surface to draw contents

Item	Neck Finish	Neck Height	Port Type
09-30-6530	38 mm	400	Double Stepped Barbed 9 mm / 13 mm
09-30-6532	38 mm	410	Double Stepped Barbed 9 mm / 13 mm
09-30-6536	38 mm	415	Double Stepped Barbed 9 mm / 13 mm
09-30-6533	43 mm	410	Double Stepped Barbed 9 mm / 13 mm
09-30-6550	45 mm	410	Double Stepped Barbed 9 mm / 13 mm
09-30-6562	70 mm	410	Double Stepped Barbed 9.5 mm / 13 mm
09-30-6560	70 mm	410	Barbed 13 mm
09-30-6561	70 mm	410	Barbed 9.5 mm



Double Stepped Barbed

Barbed with Bottom Draw-Off Tube Exit Ports



- For back packs, carboys and drums
- Cap fits large volume containers 20 liters or larger
- Cap is designed for use in an upright position and not gravity fed systems
- Barb on exit port is designed to attach large diameter flexible tubing to the outside diameter of the stem for dispensing by an instrument or pump system. The tubing is secured with a single reversed barb preventing accidental tube removal and eliminates the use of mechanical clamps
- Bottom draw-off tube port allows either rigid or flexible tubing to be attached on the channel's inside or outside diameter, allowing user to maintain the container in an upright position and aspirate / draw contents from the bottom of the container for rapid high volume flow
- Must be vented for continuous flow

Item	Neck Finish	Neck Height	Port Type
09-30-6548	38 mm	410	Barbed with Bottom Draw-Off Tube 12.5 mm
09-30-6552	58 mm	410	Barbed with Bottom Draw-Off Tube 9 mm
09-30-6553	58 mm	410	Barbed with Bottom Draw-Off Tube 12.5 mm
09-30-6554	63 mm	410	Barbed with Bottom Draw-Off Tube 9 mm
09-30-6555	63 mm	410	Barbed with Bottom Draw-Off Tube 12.5 mm



Barbed with Bottom Draw-Off Tube 12.5 mm



Barbed with Bottom Draw-Off Tube 9 mm



Plastic Threaded Gallon Jug & Cap



- Plastic square-based gallon container
- Neck finish 38 mm

Item	Product Description	UOM
05750	Square Gallon Jug, 38-410	48/Case
05751	Shipper Cap for Gallon Jug, 38-410	48/Bag



Back Pack Kits & Accessories



- Ideal for administering liquid medicants to large herds
- Quick, easy and effective
- All items are available separately

Kit includes:

- Back pack container
- Standard cap
- Vented cap
- Strap, 8 ft

Item	Product Description	UOM
05760	EuroStyle Back Pack Kit, 1 Liter	Each
05761	EuroStyle Back Pack Kit, 2.5 Liter	Each
05762	EuroStyle Back Pack Kit, 5 Liter	Each
06251	Back Pack Kit with Handle & Triangle Pocket, 2.5 Liter	Each
06254	Back Pack Kit with Handle & Triangle Pocket, 5 Liter	Each
06500BK	Shipper Cap, 38-415 HDPE Lined - Black	Each
09-30-6532BK	38-410 Vented Draw-Off Cap with Double Stepped Port, Black	Each
06805	Strap for Back Pack, 8 ft	Each



Dosing Instruments for High Volumes

See pages 197-201



Plastic Threaded HDPE & LDPE Bottles - BULK



Item	Product Description	UOM
06152	180 cc (6 oz) Cylinder Threaded HDPE Bottle, 38-400 Neck, Natural	330/Case
06152MB1	180 cc (6 oz) Cylinder Threaded HDPE Bottle, 38-400 Neck, Amber	330/Case
06200	250 cc (8 oz) Boston Round Threaded HDPE Bottle, 24-410 Neck, Natural	278/Case
06203	250 cc (8 oz) Boston Round Threaded HDPE Bottle, 28-410 Neck, Natural	278/Case
06212	400 cc (13 oz) Boston Round Threaded HDPE Bottle, 45-400 Neck, Natural	146/Case
06212WH	400 cc (13 oz) Boston Round Threaded HDPE Bottle, 45-400 Neck, White	146/Case
06213	400 cc (13 oz) Boston Round Threaded LDPE Bottle, 45-400 Neck, Natural	146/Case
06210	625 cc Boston Round Threaded HDPE Bottle with Hook, 28-410 Neck, Natural	119/Case
06210MB1	625 cc Boston Round Threaded HDPE Bottle with Hook, 28-410 Neck, Amber	119/Case
06215	625 cc Boston Round Threaded HDPE Bottle with Tab, 28-410 Neck, Natural	119/Case
06215MB1	625 cc Boston Round Threaded HDPE Bottle with Tab, 28-410 Neck, Amber	119/Case
06220	1 Liter Boston Round Threaded HDPE Bottle with Tab, 28-410 Neck, Natural	60/Case
06220MB1	1 Liter Boston Round Threaded HDPE Bottle with Tab, 28-410 Neck, Amber	60/Case



Note:
Call us to discuss your **color customization** needs.

Shipper Caps



Item	Product Description	UOM
06414BK	Shipper Cap 20-410 with Expansion Ring, Black	Each
06421BK	Shipper Cap 24-410 Lined, Black	Each
06430BK	Shipper Cap 28-410 Lined, Black	Each
06506BK	Shipper Cap 38-400 Lined, Black	Each
06510BK	Shipper Cap 45-410 with Expansion Ring, Black	Each



Plastic Serum Bottles



Plastic Serum Bottles are used to hold liquids and are available in various sizes. Serum bottles are sealed and closed using either a Rollover Sleeve Stopper or a Rubber Stopper with an Aluminum Seal which is then crimp-sealed onto the bottle.

- Available in natural or amber
- Autoclavable

Plastic Serum Bottles HDPE, Non-Sterile



Item	Product Description	UOM
05604	15 cc Plastic Serum Bottle HDPE, Natural	100/Bag
05606	25 cc Plastic Serum Bottle HDPE, Natural	100/Bag
05608	30 cc Plastic Serum Bottle HDPE, Natural	100/Bag
05610	60 cc Plastic Serum Bottle HDPE, Natural	100/Bag
05624	120 cc Plastic Serum Bottle HDPE, Natural	100/Bag



Plastic Serum Bottles HDPE, Non-Sterile - BULK

Item	Product Description	UOM
05607	15 cc Plastic Serum Bottle HDPE, Natural	1,500/Case
05609	30 cc Plastic Serum Bottle HDPE, Natural	1,000/Case
05611	60 cc Plastic Serum Bottle HDPE, Natural	600/Case
05625	120 cc Plastic Serum Bottle HDPE, Natural	400/Case
05700	120 cc Plastic Serum Bottle HDPE, Amber	400/Case
05705	250 cc Plastic Serum Bottle HDPE, Natural	278/Case
05707	250 cc Plastic Serum Bottle HDPE, Amber	278/Case
05725	500 cc Plastic Serum Bottle HDPE, Natural, Hook Bottom	140/Case
05715	500 cc Plastic Serum Bottle HDPE, Amber, Hook Bottom	140/Case
05730	625 cc Plastic Serum Bottle HDPE, Natural, Hook Bottom	119/Case
05737	625 cc Plastic Serum Bottle HDPE, Amber, Hook Bottom	119/Case
07020	1,000 cc Plastic Serum Bottle HDPE, Natural, Tab Bottom	60/Case

Note:

Don't see what you are looking for? **Contact us** to discuss your needs.

Serum Bottle Stoppers & Seals



Rubber Stoppers, Aluminum Seals and Rollover Sleeve Stoppers are used for sealing serum bottles. The 20 mm stopper is used on 25 cc to 120 cc serum bottles and the 30 mm stopper is used on 250 cc to 1 liter serum bottles.

Item	Product Description	UOM
05505	Rubber Stopper, 20 mm	100/Bag
05525	Rubber Stopper, 30 mm	100/Bag
05545	Rollover Sleeve Stopper, 20 mm	100/Bag
05550	Rollover Sleeve Stopper, 30 mm	100/Bag
05510	Aluminum Seal, 20 mm, Open Top	100/Bag
05530	Aluminum Seal, 30 mm, Open Top	100/Bag



Bottle Hangers



- Apparatus for hanging bottles for draw off
- Lightweight plastic
- Available in three sizes

Item	Product Description	UOM
07800	Bottle Hanger for 120 cc Bottles	12/Bag
07805	Bottle Hanger for 250 cc Bottles	12/Bag
07810	Bottle Hanger for 500 cc - 625 cc Bottles	12/Bag



Dropper Tip Insert, 20 mm

The Dropper Tip is designed to fit any serum bottle with a 20 mm neck finish. This tip is designed to give a drop size of the vaccine for placement into the eye of a chicken. The most popular size bottle being use is either a 30 cc or a 60 cc serum bottle made in low density polyethylene so the bottle can be squeezed to administer the drop of vaccine.



Item	Product Description	UOM
09-11-546-10	Insert - Dropper Tip - 20 mm with Notches	10/Bag

Bottle Crimpers

A heavy duty metal instrument used to crimp an aluminum seal onto a serum bottle. The 20 mm crimper is used on 25 cc to 120 cc serum bottles and the 30 mm crimper is used on 250 cc to 1 liter serum bottles.

- All metal construction
- High value extended life



Item	Product Description	UOM
05575	Bottle Crimper, 20 mm for 25 cc - 120 cc Bottles	Each
05580	Bottle Crimper, 30 mm for 250 cc - 1 Liter Bottles	Each

Transfer Spike

- Used to transfer the contents from one stoppered medicant bottle into another stoppered medicant bottle
- Ideal for lyophilized products that need to be re-hydrated utilizing a diluent
- Individually packaged and gamma irradiated
- Single use item



Item	Product Description	UOM
07817	Transfer Spike with Identical Length Spikes & Dual Port Tips	Each

Dura-Grip™ Vented Draw-Off Spikes

- Features ultra sharp point that pierces the stoppered seal of vaccine, biological or pharmaceutical bottles
- Retention grips securely attach to serum bottle - once the spike pierces the stopper and is affixed, the grips hold to the base of the foil bottle seal
- Duckbill breather valve provides rapid pressure relief while dispensing from a vial or serum bottle using continuous dispensing system
- Offered individually or bulk
- Single use item



Item	Product Description	UOM
08010	Dura-Grip™ Vented Draw-Off Spike, 20 mm with 6 mm Barb Stem, Red	Each
08013	Dura-Grip™ Vented Draw-Off Spike, 30-32 mm with 6 mm Barb Stem, Blue	Each
08016	Dura-Grip™ Vented Draw-Off Spike, 30-32 mm with 8 mm Barb Stem, Green	Each



Everseal™ Containers

Various sized, one-piece, polypropylene containers used for sampling.

- Patented, leakproof, flip-top cap seals the container tightly for transport, storage or shipment
- Sizes range from 11 cc to 300 cc
- Tamper evident cap on 150 cc and 300 cc containers ensures sample security
- Single use item

Item	Product Description	UOM
05850	Everseal™ Container, Clear, 11 cc	100/Bag
05855	Everseal™ Container, Clear, 15 cc	100/Bag
05860	Everseal™ Container, Clear, 45 cc	100/Bag
05865	Everseal™ Container, Clear, 120 cc	100/Bag
05870	Everseal™ Container, Clear, 150 cc, Tamper Evident	100/Bag
05875	Everseal™ Container, Clear, 300 cc, Tamper Evident	100/Bag



Whirl-Pak® Bags

- Plastic sample bag made of polyethylene film with a wire top to roll over the open end to seal
- Once sealed the container is used for storage, transport or shipment
- Single use item

Item	Product Description	UOM
05840	Whirl-Pak® Bag, 2 oz, 3" x 5"	500/Box
09000	Whirl-Pak® Bag, 4 oz, 3" x 7-1/4"	500/Box
61607	Whirl-Pak® Collection Bag, 18 oz	10/Bag



Fluid Bags - Gamma Irradiated

- Single use item

Item	Product Description	UOM
39200	Fluid Bag, 2 Liter, 2 Ports with 36" Tube - Gamma Irradiated	Each
39210	Fluid Bag, 2 Liter, 2 Ports with 48" Tube - Gamma Irradiated	Each
39205	Fluid Bag, 2 Liter, 2 Ports with 64" Tube - Gamma Irradiated	Each



IV Fluid Bags

- Used to administer large volumes of fluid
- Large handle for carrying or hanging
- Flexible 60" long tube
- Drip chamber controlled by roller clamp
- Gamma irradiated or EtO exposed
- Single use item

Item	Product Description	UOM
04550	IV Fluid Bag, 3 Liter with Drip Chamber, 60" Tube & Needle Adapter	Each
04551	IV Fluid Bag, 6 Liter with Drip Chamber, 60" Tube & Needle Adapter	Each



WHIRL-PAK is a registered trademark of the Aristotle Corporation.



MAI ANIMAL HEALTH EDUCATION CENTER

The source of MAI Animal Health's continuing education opportunities for the veterinary community. MAI Animal Health has been providing RACE-accredited CE learning for veterinarians and vet techs for over 20 years, and now is bringing the classroom to you with both Virtual and Live course offerings.



CE courses offered include:

- Advanced Oral Techniques for the Horse - Live and Virtual
- Small Animal Dentistry for the Everyday Practice - Virtual
- Practical Field Anesthesia and Monitoring Techniques for the Equine Patient - Virtual
- Monitoring the Small Animal Anesthesia Patient - Virtual



Visit education.maianimalhealth.com
for more information.

INDEX

A

Absorbable Sutures 104-107
AccuBreed™ Cloud Electronic Heat Detection System 31
Acid Etch Gel 74
Acrodisc® Syringe Filter 21
Acrylic Burs 55
Acrylic Temporary Crown Material 64
ADA Compliant Braille Restroom Signs 175
Adapt-A-Bottle™ Replacement Port Valve & Screw Ring 138
Adapter Plugs 26
Adson Brown Tissue Forceps 113
Aerosol Therapy Masks 130
Air Abrasion Handpiece 73
Air Accessories 195
Air-O-Matic™ 197
Albumin Solution 21
Alconox® Detergent Powder 5
Alligator Forceps 80
AlumiSpec™ 76
Anesthesia Chambers 134
Anesthesia Masks 130
Anger Management™ Chamber 134
Applicator Gun 200
Artificial Vagina & Accessories 1-3
Artificial Vagina Semen Filter 4
Aspirator Masks 133
Aspirator / Resuscitator Kits 129-132
Aspirator / Resuscitator Pumps 133
Aural Hematoma Tube 168
Auri-Kleen™ Irrigation / Aspiration / Insufflation Machine 121

B

Back Pack Kits & Accessories 213
Bag & Bottle Warmers 23
Barbed & Double Stepped Barbed Exit Ports 184, 212
Barbed with Bottom Draw Off Tube Exit Ports 184, 212
Barrels for Power Doser™ Instruments 195
Bellow Wound Irrigation / Drain System 162
BioFree Flushing Solution 23
Bio Lube® 49
Bio Lube® Lubricant Pen 75
Bi-Valve Nasal Speculum 123
Blades for The Edge Equine™ Floats 92
Blood Glucose & Ketone Meter 157
Bolus Guns 203-204
BoneWelder® Conical 2 mm Sonotrode 96
BoneWelder® Vet System 95
Bottle Adapters 185
Bottle Brush 137
Bottle Crimpers 216
Bottle Hangers 215
Bottle Warmers 23
Bovine Artificial Vagina Accessories 3
Bovine Buffer™ 207
Bovine Cervical Dilator 29

Bovine Long Y-Junction 15
Bow Ow™ Dog First Aid Kit 165
Braided Polyester Sutures 104
Breech Retractor™ 36
Buccotomy Sets 75
Bullet Tip Capped Culture Swab 12
Bullseye™ Pillgun 185
Bur Block & Cover, Magnetic 55
Bur Extractor 53
Burs & Discs for Versa-Float™ Dental Systems 68

C

Cadaver Bags 169
Cage (In-Place) Chamber™ 134
Calcium Boluses 208
Calcium Gel 207
Calculus Satelec® Tip 52
Calf Aspirator / Resuscitator Kit 132
Calf Bottles with Nipple 137
Calf Bottles with Plastic Probe 139
Calf Feeder Bag 139
Calf-Maid® Bottles 137
Calf-Maid® Nipple, Black 138
Calf Mouth Gag 139
Calf Training Model 131
Canes for Goblets 27
Canine Bullet Tip Culture Swab 7
Canine Disposable A/V Liner Kit & Collection Cones 6
Canine Insemination Pipettes 7
Canine Intravaginal A.I. Kits 6
Canine Semen Collection & Artificial Insemination Kit 6
Canine Semen Extenders 7
Canine Spay / Neuter Pack 114
Canine Training Model 131
CAT+ Doppler Blood Pressure Monitor Cuffs 128
Cautery Kit 161
Centrifuge Tube Cap 21
Centrifuge Vial / Tube 11
CentriVet™ Blood Glucose & Ketone Meter 157
Cheek Dilator 61
Chemise 28
CITO Thaw Units 27
Client Handouts 179
Clip-Its™ Visual Reminders 171-172
Clip-On Magnifying Lenses 160
CMPK Drench 208
CMPK Gel 207
Coalescent Filter 47
Colorado Artificial Vagina & Accessories 1
Colostrum Probes 140
Compassionate Signs 177
Complete Ultra Flushing Solution 22
Compressor Oil 46
Compressor Pick Up / Collection Bottle 48
Conditioning Solution for Artificial Vagina Liners 4
Corridor Signs & Mounts 176
Cover Slips 10
Cradle Style Equine Head Rests 78

INDEX

Crossley Incisor Luxator 62
Cuzzo Guns 28
Curettes 62, 122

D

Deep Chamber Artificial Insemination Catheters 17
Dehorning Paste 152
Deluxe Bovine Artificial Vagina Complete 3
Dental Cart Systems 39-40
Dental Chart 93
Dental Floats 87-91
Dental Halter System 78
Dental Instrument Packs 63
Dental Invoice / Chart 93
Dental Mouth Mirror 61
Dental Rinse 93
Dental Work Stations 43
Dentanomic Accessories 58
Dentanomic Dental Kits 56, 66
Dentanomic Equine Contra Angle Blades 57, 83
Dentanomic Ergonomic Handles 57, 83
Dentanomic Full Set Replacement Blades 56
Dentanomic Luxation Blades 57, 83
Dentanomic Luxation Blades - Equine 57, 83
Dentanomic Starter Kits 56
Dentanomic Elevation Blades 57
Derma Manage-Mint™ & Derma Mist™ 145
Derma-Mint™ 144
Diamond Discs 55
Diaphragms & Accessories for McCulloch Medical™ Masks 131
Diastema Burs 67
Diopter Aspheric Lens 157
Disposable Artificial Vagina Kit 2
Disposable Oscillating Prophy Angles 48
Disposable Float Blades 92
Disposable Sleeve 35
Double-Guarded Cytology Brush 13
Double-Guarded Uterine Culture Swab 12
Double Well Dish 24
Double Well Oocyte Aspiration Dish 20
Draw-Off Caps 183, 211
Draw-Off Pump It™ 189
Dr. Hanson's Bullseye™ Pillgun 185
Drilled Pipettes 18
Dr. Larson's™ Aural Hematoma Tube 168
Dr. Larson's™ Bovine Buffer™ 207
Dr. Larson's™ CMPK Drench 208
Dr. Larson's™ CMPK Gel 207
Dr. Larson's™ Dehorning Paste 152
Dr. Larson's™ Derma Manage-Mint™ & Derma Mist™ 145
Dr. Larson's™ Derma-Mint™ 144
Dr. Larson's™ Frost Free™ Plus 144
Dr. Larson's™ Horn-Check Paste 152
Dr. Larson's™ Keto Gold™ 207
Dr. Larson's™ Keto Gold™ 1000 207
Dr. Larson's™ Niacin Drench 208
Dr. Larson's™ Non-Irritating Calcium Gel 207
Dr. Larson's™ Teat Tubes 146

Dr. Larson's™ Up & Over™ Plus 208
Dropper Tip Insert 216
D*Tach™ Bur Extractor 53
Dura-Grip™ Vented Draw-Off Spikes 186, 216
DVM Rapid Test™ I Analyzer Tests 9
DVM Rapid Test™ II Router 10
DVM Rapid Test™ II - Sperm Concentration Analyzer 9

E

E-Series I - Table Top Electric Dental Unit 45
Ear Cleaning Cannulas 121, 157
Ear Cleansing 121
Ear Loop Curettes 122
Ear Tag Applicator 170
Ear Tag Pliers 170
Economy Artificial Vagina Filler 4
EduPad™ Client Handouts 179
EduPet™ Client Handouts 179
EEZY-Drive™ Pro Motor System 71
EEZY-MaXX™ Reciprocating Float 69, 94
EEZY-View™ LED Rechargeable Headlight 159
Elevators 59, 60, 82, 83, 84
Elevator Set 60, 81, 82
Ellis Uterine Detorsion Rod 37
Embryo Filter Holder 21
Embryo Transfer & Artificial Insemination Gun Warmer 23
Embryo Transfer Catheter with Flex Adapter 25
Embryo Transfer Filters 19, 20
Embryo Transfer Mini-Guns 28
EMCARE™ BioFree Flushing Solution 23
EMCARE™ Complete Ultra Flushing Solution 22
EMCARE™ Ethylene Glycol 1.5M 22
EMCARE™ Glycerol 10% v/v 22
EMCARE™ Holding Solution 22
EMCARE™ Sucrose 34.2% w/v 1M 22
EMCARE™ Thawing System 22
Em Con™ Embryo Filter Holder 21
Em Con™ Filter 19
Em Con™ IVF Oocyte Filters 20
Employee Identifier - 3" x 1" 176
EMT IV Giving Sets 140
Endoscope Instruments 118
Endoscope Video Adapters 124
Endoscopic Aspiration Kits 119, 155
Endoscopic Culture Swabs 119, 155
Enema Zip Top Bag with Foal Tip 144
Engraved Business Signs 174-176
Engraved Name Badges 177
EQ Mini Power Float™ 70
EQ Power Float™ 69
Equi-Flex Pipette with Tube Protector 17
Equine Artificial Insemination & Infusion Kits 17
Equine Cadaver Head Holder 79
Equine Cheek Retractor 77
Equine Dental Chart 93
Equine Dental Explorer 81
Equine Dental Probe 80

Equine Dental Rinse, OralEQ™ 93
Equine Dental Scaler 81
Equine Dental Scope System 75
Equine Dental Systems Flexidisc 72
Equine Dental Systems Polyfloat & Accessories 72
Equine Diagnostic Kit 80
Equine Extraction Kit 85
Equine Eye Pack 115
Equine Fine Point Periodontal Forceps 81
Equine Head Rests 78-79
Equine Long Y-Junction 16
Equine Mouth Mirror 81
Equine Periodontal Pick 80
Equine Periodontal Pick Set 80
Equine Periodontal System & Accessories 73-74
Equine Radiography Top 78
Equine Skull Model & Teeth Set 93
Equine Stallion Urinary Catheter 11
ESP™ Tissue Culture Dishes 25
ESTROTECT™ Bovine Self-Locking Embryo Transfer Gun 28
ESTROTECT™ Breeding Indicators 32
E.T. Filter Cup 20
E.T. Filter with Y-Junction 20
Ethylene Glycol 1.5M 22
Everseal™ Containers 217
Exam Room Otoscope System 120
Exit Ports 184
Extend-A-Pole Snares 149
Extended Syringe Tip 73
Extension Set for IV Giving Sets 142
Extension Set with Syringe Adapter & Spike 16
ExtractEZE™ Root Tip Remover 58
Extractors 83, 85, 86
Extra-Flex™ Bolus Guns 204
Eye Pack 115
E-Z Artificial Vagina Filler 4
EZ Spec Mouth Speculum 77

F

Fecal Baggies 153
Fecal Flotation Kits & Accessories 153
Fecal Loops 153
Feline / Brachy Muzzle 150
Feline Elevator 59
Feline Non-Absorbable Litter & Trays 154
Feline Spay / Neuter Pack 114
Feline Urine Collection Kits 154
Fetal Repeller 37
Fiber-Optic Light Bulb for High Speed Handpiece 53
File, Diamond "S" 92
Filter Element 47
Filter for Micro Mist Separator 47
Filter Warmers 23
First Aid Kits 164-166
Flea / Lice Combs 167
Flexible Micro-Endoscopes 122
Flexi-Float™ Ultra Complete Kit 67
Flex Tip Infusion Pipettes 18

Floats for No. 1, No. 2, No. 3 Upper & No. 1 Lower Premolars 88
Floats for No. 1 Upper & Lower Premolars 87
Floats for Upper No. 3 to No. 6 & Triadan Nomenclature 89
Floats for Upper No. 6 Cheek Teeth Rear Molars 89
Fluid Bags - Gamma Irradiated 217
Fluoromid™ / Fluromid™ Sutures 103
Flush Bag with Y-Junction 16
Foal Aspirator / Resuscitator Kit 132
Foal Training Model 131
Forceps 122
Forceps (Equine) 80, 84, 85
Foredom™ Motors 71
Four Well Dish 24
Frost Free™ Plus 144
Fulcrum Sets 86
Funnels 136, 202

G

Gasket for Water Bottle 48
Gaskets for High / Low Speed Handpiece 48
Gastrosopes 117
General Dental Invoice / Chart 93
Genesis Implant Guns 205
Genesis Infusion Cannula 145
Genesis Microchip Delivery 168
Genesis Microchip Implanter 205
Genesis Teat Dilator 145
German Canine Spay / Neuter Pack 114
German Feline Spay / Neuter Pack 114
Gingival Elevator Set, T-Handle 81
Glide AI™ Lubricant 33
Glide OB™ Lubricant 33
Glycerol 10% v/v 22
Goblets 27
Gotcha™ Muzzle Handles 150
Gripper™ Shoulder-Length Plastic Sleeves 35
Gripper™ Ultra-Sens™ Sleeves 35
Gripper™ Yellow Sof™ Sleeve 35
Gunther Speculum 75

H

Halkey-Roberts® Clamp 151
Hand Floats 87-91
Handi-Dipper™ 147
HANDI GRIP™ Feeder & Storage Bottles 138
Handpiece Drills 72
Hanger for Latex Liner 5
Harlton's Mouth Wedge 77
Har-Vet™ Artificial Vagina & Accessories 2
Har-Vet™ Semen Extenders & Accessories 8
Headlights, LED 158-159
Head Rests, Equine 78-79
Head Snare 148
Heat Detection System 31
Heidbrink Root Tip Picks 61
Hemostats 111-112
Hi-Flow™ Dosing Syringes 197

INDEX

Hi-Flow™ Plus Dosing Syringes 198
High Performance Mixing Gun 74
High Speed Extension 73
High Speed Handpieces & Replacement Turbines 52-53
High Speed, High Torque Handpiece 73
High Speed Push Button Back Cap Replacement 53
High Torque Handpiece 73
Holding Solution 22
Horse Aid™ Kit 164
Hylton LDA Repair Kit 152

I

IgG Serum / Plasma & Colostrum Test Kits - Bovine 9
IgG Serum / Plasma & Colostrum Test Kits - Equine 9
IgG Serum / Plasma Test Kit - Camelid 9
Impression Material 74
Indwelling Bloat Whistle 152
Informational Fire Signs 177
Informational Outdoor Signs 175
Infusion Cannula 145
Infusion Pipettes 7, 18
Inovadent™ Dental Cart Systems 39-40
Inovadent™ Dental Work Stations 43
Inovadent™ HS4W Dental Cart System 40
Inovadent™ HS4 Counter Top Dental Work Station 43
Inovadent™ HS4W Counter Top Dental Work Station 43
Inovadent™ Swing Arms 44
INRA 96 Semen Extender 8
Insemination Cuozzo Guns 28
Intake Filters 47
Intermediate Implant Device 205
Intra Oral Tip 74
In Vitro Fertilization & Transfer Catheters 25
Irrigation / Aspiration Machine 121
IV Bag Hanger 141
IV Delivery System 141
IV Fluid Bags 141, 217
IV Giving Sets 140-142
IV Simplex 142-143
IV Simplex Adapter 143
IV Spike with Tubing 142
IVF Catheters 25
IVF Oocyte Aspiration Dish 20
IVF Oocyte Filters 20
IVF Threaded Centrifuge Tube Cap 21

J

Jerry's Powered Float Accessories 70-71
Jug Pumps 143
JUN-AIR® Compressor Oil 46
JUN-AIR® Regulator Filter 46

K

K9 Aspirator / Resuscitator Kit 166
K9 Police & Military First Aid Kit 166
Kennel Bowl, MaxLatch™ Clip-on 167
Keto Gold™ 207

Keto Gold™ 1000 207
KLAW™ Tips 50
KLAW™ Wrench 50

L

Lamb / Kid / Alpaca / Cria / Miniature Foal Aspirator / Resuscitator Kit 132
Laparoscopic Insemination 124
Large Bore Flex Tip Infusion Pipettes 18
Large Bore IV Set 142
Large Implant Device 205
Laryngoscope Kit 160
Laser X-ray Guide 65
Latex OB Sleeves 36
LDA Repair Kit 152
Lead Gloves 169
Leather "X" Strap Muzzles 150
LectraVet™ & Accessories 194
LED Clip Light for Surgical Loupes 158
LED Headlights 158-159
LED Pet Piezo™ Scaler 50
LikShield™ 163
Long Y-Junctions 15
Low Speed Handpieces 53
Low Speed Handpiece for Equine Periodontal Unit 73
Lubrifiuid™ Lubricant 45
Luer Lock Draw Off Caps 183, 211
Luer Slip & Genesis Oral Syringe Draw Off Caps 183, 211
Luxation Blades 57, 83

M

Magnetic Bur Block & Cover 55
Magnetic Spec BiteLite™ Accessories 77
Magnifying Lenses 160
Magnum Sleeves 35
MAI Fecal Flotation Kit 153
MAI Fecal Loops 153
MAI Feline Non-Absorbable Litter & Trays 154
MAI High Volume Embryo Transfer Filter 19
MAI IV Simplex 142
MAI Low Volume Embryo Transfer Filter 19
Maintenance Kits 46
MAI Oral Calf Feeder Bag 139
Masks, Oxygen Recovery 130
Mastitis Syringe & Cap Combinations 209
MaxLatch™ Clip-on Kennel Bowl 167
McCalls Curette 17/18 62
McCulloch Medical™ Aerosol Therapy Masks 130
McCulloch Medical™ Anesthesia Masks 130
McCulloch Medical™ Aspirator Masks 133
McCulloch Medical™ Aspirator / Resuscitator Pumps 133
McCulloch Medical™ Diaphragms & Accessories 131
McCulloch Medical™ OnePuff™ Aspirator / Resuscitator Kits 129
McCulloch Medical™ Oxygen Recovery Masks 130
McCulloch Medical™ Respiratory Training Models 131
McCulloch Medical™ Resuscitator Masks 133
McCulloch Medical™ Supplemental Oxygen Adapters 133

Med-Eze™ Cart Pump 135, 201
Med-Eze™ Oral Delivery Pump 135, 201
Med-Eze™ Oral Delivery System Accessories 136, 202
Med-Eze™ Stomach Pump 136, 187, 202
Medi-Cartridge™ Applicator Gun 200
Medi-Cartridge™ with Seal & Cap 210
Me Ow™ Cat First Aid Kit 165
Mesial Spreaders 86
Metallic Tip Sheaths 29
Micro Applicator Brush 64
Microchip Delivery Syringe, Genesis 168
Micropipette Tips 10
Microscope Slides 11
Mighty EZ Float Kits 70
Milk Tubes 146
Minipet Pipettors 10
Mini & Pony Head Rests 79
Mini EZ Spec™ Mouth Speculum 77
Mirrors 61, 81
Missouri Artificial Vagina & Accessories 1
Mixing Gun 74
Mixing Spatula 64
Mixing Tip 74
Molar Cutters 61
Molar Rasps 62
Mouth Gag for Rodents 61
Mouth Gags 168
Mouth Mirror, Equine 81
Mouth Speculums 76-77
"MS" Hand Floats 91
Multi-Bolus Guns 203
Multi-Dose™ Oral Tip Syringes 209
Muzzles 149-150

N

Name Badges, Engraved 177
Name Badges, Sublimated 178
Nasal Speculum 123
Nasopharyngeal Swab 156
Needle Adapter & Cap 143
Needle Holders 113
Needle Reference Chart 108-109
Niacin Drench 208
Nipple, Black 138
Nipple with Screw Ring 138
Non-Absorbable Litter & Trays 154
Non-Absorbable Sutures 103-104
Norm-Ject® Syringes 30, 181
Nozzles for Power Doser™, Air-O-Matic™, Hi-Flow™, Hi-Flow™
Plus & V-Grip™ Instruments 196, 199
Nylon Muzzles 149

O

Oaths - Wood Plaques 177
OB Sleeves, Latex 36
Oil Compressors 46
Oil-less Compressor 46

Olsen Hegar Needle Holders 113
One Puff™ Aspirator / Resuscitator Kits 129
OnPointe™ Laser X-ray Guide 65
Operating Otoscope Kit 120
Oral Calf Feeder Bag 139
Oral Delivery Pump 135, 201
OralEQ™ Equine Dental Rinse 93
ORAL MEDS™ Dispensers 167, 185
Oral Pump It™ 188
Oral Pump It™ Modular 188-189
Oral Surgery Packs 63
Orthopedic Mallet 86
Osteotome, Hibbs 86
OtoKleen™ Ear Cleaning Cannulas 121, 157
OtoKleen™ Ear Cleansing Solution 121, 157
Ova Transfer Dish 24
Ovine Artificial Vagina Complete & Accessories 3
Oxygen Recovery Masks 130

P

Pacific Edge™ Mouth Speculum 76
Palm Grip™ 200
Pear-Shape Burs 55
Periodontal System & Accessories, Equine 73-74
Perio Satelec® Tips 52
Pet Piezo™ Scaler 50
Petri Dish 25
Phoenix™ Dosing Instrument 200
Phoenix Wound Lavage System 162
Piezoelectric Scaler Handpiece 51
Piglet Aspirator / Resuscitator Kit 132
Pill Guns 168, 185
Pipette Protectors 18
Pipettors & Accessories 10
Plastic Probes 139
Plastic Serum Bottles 214-215
Plastic Straw Tweezers 27
Plastic Threaded Gallon Jug & Cap 213
Plastic Threaded HDPE & LDPE Bottles 214
Police & Military First Aid Kit, K9 166
Polydioxanone Sutures 107
Polyfloat Burs 72
Polyglycolic Acid Sutures 106-107
Poly Sens Sleeve 34
Pony / Mini Artificial Vagina Complete Kit 2
Portable Patient Monitor 125, 127
Portable Video Endoscope 121
Portable Woods Lamp 160
Pour-On Dipper 202
Power Doser™ Instruments & Accessories 195
Power Floats 69
Power Handle™ Rotary Floats & Accessories 69
Power Motor with Foot Pedal 71
Practical Pet First Aid Book for Dogs & Cats 165
Premium Leather Muzzles 149
Press-In Bottle Adapters 185
ProBang™ Uterine Baton 36

INDEX

Probes 62
ProFil™ Flowable Composite 74
Pro-Ject™ 2-Piece Syringes - Luer Slip & Luer Lock Tips 30, 181
Pro-Ject™ 2-Piece Syringes - Oral Foley Tip 181
Pro-Ject™ 3-Piece Syringes - Luer Slip & Luer Lock Tips 182
Pro-Ject™ 3-Piece Syringes - Oral Foley Tip 182
ProLink™ Bonding Agent 74
Prophy Paste 49
Pump It™ 45 187
Pump It™ Modular 188-189
Puppy Training Model 131

Q

Quick Disconnect for Water Bottle 48
Quick Draw™ Feline Urine Collection Kit 154
Quick Float™ Kit 70
Quick Tip™ IV Simplex 143
Quick Tip™ IV Simplex Adapter 143
Quik Lift Conversion Post 79

R

Rapid Flow Y-Junction with Foley Adapter & Spike Connector 15
Rectal Rings & Accessories 151
Regulator Filter 47
Regulator Filter Replacement Kit 47
Reminder Cards 178
Replacement Turbine for High Speed, High Torque Handpiece 73
Resorb Pins 98
Resorb Plates & Meshes 99
Resorb Plus+ Plates 99
Resorb System Instruments 97-98
Respiratory Training Models 131
Resuscitator Kits 129
Resuscitator Masks 133
Retractable Injector 118
RFID Implanters 205
Ribbed and Double Stepped Ribbed Exit Ports 184, 212
Rigid Endoscope System 123
Rite-Count™ 198
Rodent Tongue Spatula 61
Room Identification Business Signs, Engraved 176
Root Tip Remover, ExtractEZE™ 58
Round Tip Burs 54
Round Tip Bur #8, Equine 74

S

Safety Leather Muzzles 149
Sanitation Signs 175
Satelec® LED Scaler Handpiece 51
Satelec® Standard Piezo Scaler Handpiece 51
Satelec® Tips 52
Scaler 62
Scaler Metric Tips 52
Scaler - Standard Piezo Tips 51
Scalpel Handle 114

Scissors 112-113
Scott™ Nozzle 145
Sealing Rods 26
Secondary Set with Spike for IV Giving Sets 142
Select Doser™ & Accessories 191-193
Semen Collection Bottle 4
Semen Extenders, Canine 7
Semen Extenders, Equine 8
Semi-Flexible Micro-Endoscopes 122
Sensor Sleeve 64
Serum Bottles 214-215
Serum Bottle Stoppers & Seals 215
Service & Repair Kits for Power Doser™ Instruments 196
Sheaths 29
Shipper Caps 214
Short Y-Junctions 15
Shorty™ Sutures 102
Shot Shield™ 148
Shoulder-Length Plastic Sleeves 34
Shyr™ Milk Tubes 146
Shyr™ Professional Sleeves 34
Shyr™ Pro-Max Sleeves 34
Shyr™ Teat Tube with Cap 146
Silicone Foley Catheters & Accessories 14
Silicone Stomach Tubes 136, 187, 202
Silver Bolus™ Balling Guns 204
SilverGlide™ Suture Cross Reference Chart 101
Simplex Funnel with Foley Adapter 14
Simplex Uterine Flushing Catheter 14
Single LED Headlights 159
Single Line Uterine Lavage Tubing 13
Skull Models - Small Animal 64
Skull Model and Teeth Set - Equine 93
Sleeves 34, 35
Small Animal Head Snare 148
Snares, Extend-A-Pole 149
Snook Ovariectomy Hook 114
Sof™ Sleeves 34-35
Spay / Neuter Pack, Canine 114
Spay / Neuter Pack, Feline 114
Spec BiteLite™, Magnetic 77
Specimen Shipper, VIP Impact™ 11
Speculum, Gunther 75
Speculums, Mouth 76-77
Speculums, Uterine 13
Sperm Concentration Test 10
SpinStir™ & Accessories 190
Sporting Dog™ II First Aid Kit 164
Sporting Dog™ Premium First Aid Kit 164
Spotlight LED Standard Head High Speed Handpiece 52
Spraynet™ Cleaning Spray 45
Spray Tip Applicators 167, 190
Spreaders 86
Square Gridded Dish 24
Squeeze-Jet™ Dispensers & Accessories 209
Stainless Steel Probes 140
Stallion Condom 11
Stallion Urinary Catheter 11

Standard Bovine Artificial Vagina Complete 3
 Standard Dental Floats 91
 Standard Piezo Tips 51
 Standard Spreaders 86
 Standard Style Head Rests 78
 Standard, Universal & Metallic Tip Sheaths 29
 Sta-put™ Ear Tag Applicator 170
 Sta-put™ Ear Tag Pliers 170
 StatPet™ Micropipette 10
 STIP™ Tip Canine Insemination Pipettes 7
 STIP™ Tip Sheaths 29
 Stomach Pump, Med-Eze™ 136, 187, 202
 StopLik™ 163
 Storage Caps for 2, 3 & 4 Liter Bottles 138
 Straw Adapters 26
 Straw Cutter 26
 Straws 26
 Straw Tweezers, Plastic 27
 Stylized Numbers - Business Signs 176
 Sublimated Business Signs 178
 Sublimated Name Badges 178
 Sublimated Oval Room ID Signs 178
 Sucrose 34.2% w/v 1M 22
 Suction Unit 118
 Supplemental Oxygen Adapters 133
 Sure Flush™ Embryo Transfer Filter 19
 Surgical Loupes 158
 Surgical Suction Unit 118
 Suspended Style Head Rest 79
 Sutures 102-110
 Swartz Wolf Tooth Elevator 83
 Swing Arms 44
 Syringe, 550 ml 82, 137
 Syringe Button Repair 54
 Syringe Caps 30, 182
 Syringe Draw-Off Caps 183, 211
 Syringe Filling Accessories 209
 Syringe Flush with Foley Connector - Long 16
 Syringe Flush with Foley Connector - Short 16
 Syringe Replacement Tip 54
 Syringes, Multi-Dose™ Oral Tip 209
 Syringes, Norm-Ject™ 30, 181
 Syringes, Pro-Ject™ 2-Piece - Luer Slip &
 Luer Lock Tips 30, 181
 Syringes, Pro-Ject™ 2-Piece - Oral Foley Tip 181
 Syringes, Pro-Ject™ 3-Piece - Luer Slip &
 Luer Lock Tips 182
 Syringes, Pro-Ject™ 3-Piece - Oral Foley Tip 182
 Syringe Tapered Barrel Kit 54
 Syringe to Catheter Connector 16
 Syringe with Short Tip 73

T

Table Tent Sign 177
 Tabs for Canes 27
 Tapered Fissure Burs 54
 Teat Curette Set 147
 Teat Dilator 145

Teat Sphincter Dilator 146
 Teat Tubes 146
 Thawing System 22
 Thaw Units 27
 The Clicker™ Multi-Bolus Guns 203
 The Edge Equine™ Floats 87-90
 The Edge Equine™ Periodontal Pick 80
 The Edge Equine™ Water Pick Kits & Accessories 82
 The Gripper™ Bolus Guns 204
 The Gripper™ Pill Guns 168, 185
 "The Slider" Room Signs 176
 "The Tickler"™ CGS Electrojector 5
 The Whiplash™ Complete 135, 201
 The Whiplash™ Oral Delivery System Accessories 136, 202
 Tieglund Uterine Culture Swabs 12
 Tie-Up™ Canine Intravaginal A.I. Kits 6
 Tissue Culture Dishes 25
 Tissue Forceps 113
 Tom Cat Catheter 25
 Tongue Spatula, Rodent 61
 Towel Clamps 114
 Tracheal Wash Kits 156
 Training Models 131
 Transcervical Insemination Endoscope Kits 124
 Transfer Spike 216
 Transition™ Calcium Bolus 208
 Trochar 170
 Turley Implant Gun 205
 Twelve Well Trypsin Dish 24

U

Ultima 250 44
 Ultima 500 41
 Ultima 600 42
 Ultima E-Style Low Speed Polisher 53
 Ultra Scale™ Solution 49
 Ultra-Sens™ Sleeves 34
 Ultra-Sens™ Sleeves, Gripper™ 35
 Ultrasound Probe Cover 36
 Umbilical Clamps 151
 Universal Satelec® Tip 52
 Up & Over™ Plus 208
 Urine Collection Kits 154
 Urine Kit 153
 Uri-Void™ Feline Urine Collection Kit 154
 USI Dental Packs 63
 USI Oral Surgery Packs 63
 Uterine Culture Swabs 12
 Uterine Flushing Catheters 14
 Uterine Flush with Enema Tip 13
 Uterine Speculums 13

V

Valve, 3 Way 16
 Valve for Air / Liquid Core Housing 5
 Vented Draw-Off Spikes, Dura-Grip™ 186
 Vented Draw-Off Spike Tube Systems 186

Versa-Float™ Kits 68
Versa Air Abrasion Handpiece 73
Versa LED High Speed Handpiece 52
Vet Case, DVM Medical 169
Vetcorder Airmate™ 126-127
Vetcorder™ Pro 125, 127
Veterinary Small Animal Medical Bag 169
Vet Periosteotome 60
Vet Tech Pack 115
VetWelding® Oral Maxillofacial and Orthopedic Sets 100
VetWelding® Resorb Pin and Plate System 97
V-Grip™ Bolus Guns 203
V-Grip™ Dosing Instruments 199
Video Endoscopes 117
Video Otoscope System with Auri-Kleen™ 120
VIP Impact™ Specimen Shipper 11

W

Warmers 23
Water Bottles for Dental Cart 48, 73
Water Delivery System 44
Water Pick Kits & Accessories 82
Watson Twitch 161
Weldix® 2.3 mm Anchor 96
Weldix® 2.3 mm Anchor Instrument 96
Whirl-Pak® Bags 217
Wild Child™ Chambers 148
Winged Elevators 60
Wolf Tooth Elevators 83
Wound Irrigation / Drain System 162
Wound Lavage System 162
Wrapid-CUT™ 162
Write-Boards™ 173

X

X-ray Guide, Laser 65
X-ray Shield 64
X Spec™ Equine Speculum, Wide 76

Y

Yellow Sof™ Sleeves 34
Y-Junctions 15
Y-Junction Uterine Flush with Enema Tip 16

DISCLAIMER: No warranties of any kind are made beyond the description of the products. MAI Animal Health hereby disclaims all warranties of merchantability and fitness for a particular purpose. If for any reason our products shall be proven defective, our damages are limited to the purchase price of the product.

Merchandise available and related images of are subject to change without notice.

©2023 MAI Animal Health. All rights reserved.

WE APPRECIATE YOUR BUSINESS!

02-72-506-CAT H

NO MORE FENCES



MAI ANIMAL HEALTH

FAMILY OF BRANDS
WORLD TOUR

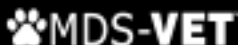



MAI ANIMAL HEALTH



www.maianimalhealth.com